

Catálogo profesional

Hoterali@GROUP



Estimados clientes,

Tenemos el placer de presentarles nuestro nuevo catálogo de productos para el sector profesional del canal HORECA, donde encontrará más de 10.000 productos que han sido seleccionados para satisfacer la demanda de todos los profesionales del sector.

Cooperamos con las marcas más prestigiosas y de renombre del sector, esto nos permite poder ofrecer a todos nuestros clientes una selección de productos de alta calidad y valor añadido que aportarán una diferencia mayor a su negocio.

Nuestra gama de artículos con marca propia han sido seleccionados y fabricados en cooperación con los mejores fabricantes del sector, para poder ofrecer a nuestros clientes la mejor relación-calidad-precio del mercado.

La unión y fuerza de un gran grupo como es Hoteralia trabaja para aportar soluciones a todos nuestros clientes en el día a día, mediante la distribución nacional e internacional del sector de equipamientos y servicios de hostelería.

Contamos con más de 100 años de experiencia en el sector, como así lo demuestran algunas empresas que forman parte de este grupo.

Nuestros valores son: **compromiso de servicio y atención personalizada a clientes.**

Disponemos de unas infraestructuras compuestas por 44 almacenes, con una capacidad de almacenamiento de más de 36.895 m². Realizamos más de 20.000 entregas mensuales a nuestros clientes finales, con nuestra flota de 150 vehículos. Nuestro grupo está formado por un gran equipo humano de 280 personas en plantilla, quienes prestan la mejor atención a nuestros más de 37.600 clientes nacionales.

* Hoteralia se reserva el derecho a cambiar o sustituir los productos que aparecen en este catálogo y que puedan haber sufrido cambios por el fabricante sin previo aviso.

ÍNDICE

| | |
|--------------------------------------|-----|
| ● Vajilla..... | 003 |
| ● Cristalería..... | 057 |
| ● Cubertería..... | 113 |
| ● Cuchillería..... | 139 |
| ● Cocina..... | 155 |
| ● Cafetería y servicios de mesa..... | 193 |
| ● Almacenaje..... | 215 |
| ● Buffet y catering..... | 235 |
| ● Maquinaria..... | 279 |
| ● Textil y vestuario..... | 303 |
| ● Consumibles | 313 |



VAJILLA

Crockery • Vaiselle • Vasellame • Geschirr



Bone Fine China



La porcelana Bone Fine China, también conocida como Bone China, es una porcelana de ceniza de hueso compuesta por un tipo de pasta de porcelana fosfática, además de caolín, feldespatos y cuarzo, que contiene un mínimo del 30% de ceniza de hueso utilizada para la fusión de los diferentes materiales que la componen.

Caracterizada por un alto grado de blancura y transparencia, su dureza y alta resistencia a los golpes, hacen de esta porcelana una de las más nobles y mejores porcelanas del mundo.



95973 (Gold)-BD5220
Plato presentación
30 cm.



50180-5312
Plato presentación 30 cm.



50180-5220
Plato pasta 30 cm.



50180-5242
Plato llano 27 cm.



50180-5243
Plato llano 23 cm.



50180-5244
Plato postre 21 cm.



50180-5245
Plato pan 18 cm.

Sprit



50180-5304
Plato hondo 23 cm.



50180-5219
Plato pasta 27 cm.



50180-3452
Plato pasta 23 cm.



Fuentes



50180-5314
38 cm.

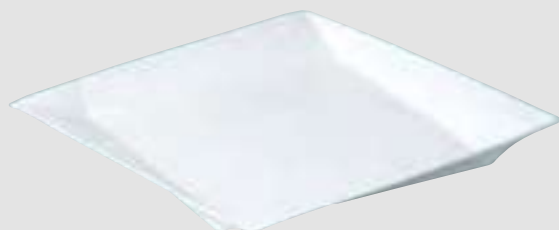

50180-3430
Plato cuadrado 33 cm.

50180-3449
43 cm.

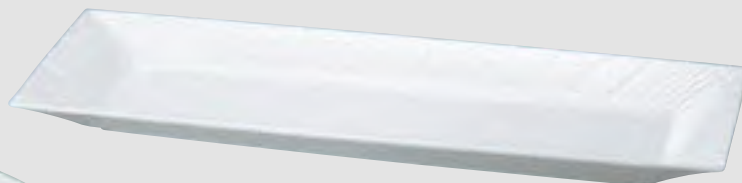

50180-3448
28 cm.

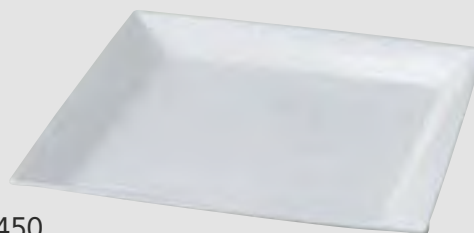

50180-3450
Plato llano 28 cm.

50827-5371
60x26 cm.



50827-5372
60x20 cm.



50827-5383
40 cm.

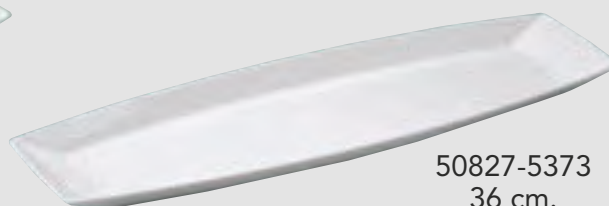

50827-5373
36 cm.

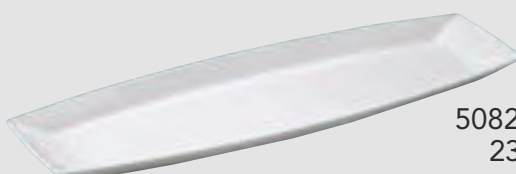

50827-9743
23 cm.

Oval



50617-5301
Plato 30 cm.



50617-5300
Plato lágrima llano 28 cm.



50617-5302
Plato 17 cm.



50617-5298
Plato lágrima hondo 28 cm.

Presentación



95973 (Gold)-BD5220
Plato presentación 30 cm.



50730-5270
Plato cuadrado 27 cm.



50180-887
Plato palette 40 cm.



51091-5509
Fuente rectangular
42 cm.



51091-5507
Plato cuadrado 30 cm.



Resistencia

La porcelana vitrificada tiene un alto contenido de alúmina lo que confiere una extrema dureza y resistencia al desportillamiento.

Durabilidad

La especial fórmula de nuestro esmalte lo hace adecuado para el uso extremo en restauración por su gran resistencia al golpeo, la abrasión y los detergentes.

Microondas

Los productos vitrificados Continental pueden ser utilizados de forma segura en hornos microondas ya que no contienen metales preciosos en su esmalte o decoración.

Higiene

La porcelana vitrificada Continental es impermeable al agua. La esmaltación de la base de las diferentes piezas evita la absorción de agua y otros materiales.

Customización

Ofrecemos la posibilidad de personalizar el producto con su logo y otros destacados.

Calidad

Continental utiliza los principios ISO-9002 para asegurar la consistencia del producto a través de estándares desarrollados a lo largo de muchos años de liderazgo en el sector.



Polaris



Continental

Plato llano



| Referencia | Medidas | Cantidad |
|------------|---------|----------|
| 55CPWD196 | 31 cm Ø | 12 |
| 55CPWD102 | 29 cm Ø | 12 |
| 55CPWD101 | 27 cm Ø | 24 |
| 55CPWD001 | 25 cm Ø | 24 |
| 55CPWD302 | 23 cm Ø | 24 |
| 55CPWD009 | 20 cm Ø | 24 |
| 55CPWD004 | 17 cm Ø | 24 |

Fuente oval



| Referencia | Medidas | Cantidad |
|------------|---------|----------|
| 55CPWD073 | 38 cm | 12 |
| 55CPWD076 | 30 cm | 12 |
| 55CPWD075 | 28 cm | 12 |
| 55CPWD125 | 25 cm | 24 |
| 55CPWD074 | 23 cm | 24 |
| 55CPWD122 | 20 cm | 24 |

Plato ondo/pasta



| Referencia | Medidas | Cantidad |
|------------|---------|----------|
| 55CPWD103 | 28 cm Ø | 12 |
| 55CPWD104 | 26 cm Ø | 12 |
| 55CPWD005 | 23 cm Ø | 24 |

Fuente rectangular



| Referencia | Medidas | Cantidad |
|------------|---------|----------|
| 50CCPWD079 | 30 cm | 12 |
| 50CCPWD078 | 35 cm | 12 |

Plato pizza



| Referencia | Medidas | Cantidad |
|------------|-----------|----------|
| 50CCPWD195 | 31,5 cm Ø | 12 |
| 50CCPWD194 | 26,5 cm Ø | 12 |

Fuente oval ala ancha



| Referencia | Medidas | Cantidad |
|------------|---------|----------|
| 55CCPWD078 | 35 cm | 12 |
| 55CCPWD078 | 32 cm | 12 |



Continental



Plato cuadrado

| Referencia | Medidas | Cantidad |
|------------|---------|----------|
| 20CCEVW139 | 28 cm | 12 |
| 20CCEVW151 | 23 cm | 12 |
| 20CCEVW870 | 18 cm | 24 |



Plato triangular

| Referencia | Medidas | Cantidad |
|------------|---------|----------|
| 20CCEVW206 | 26 cm | 12 |
| 20CCEVW140 | 19 cm | 24 |



Plato sushi

| Referencia | Medidas | Cantidad |
|------------|---------|----------|
| 50CCEVW142 | 27 cm | 12 |



Ensaladera Square

| Referencia | Medidas | Cantidad |
|------------|---------|----------|
| 20CCEVW162 | 24 cm | 12 |
| 20CCEVW161 | 21 cm | 12 |
| 20CCEVW160 | 18 cm | 12 |



Bol arroz

| Referencia | Medidas | Cantidad |
|------------|-----------|----------|
| 20CCEVW132 | 15,5 cm Ø | 12 |
| 20CCEVW133 | 13,5 cm Ø | 12 |
| 20CCEVW131 | 12,5 cm Ø | 12 |
| 20CCEVW200 | 10,5 cm Ø | 12 |



Bols

| Referencia | Medidas | Cantidad |
|------------|---------|----------|
| 20CCEVW134 | 15 cm Ø | 12 |
| 20CCEVW135 | 15 cm Ø | 24 |



Plato 4 departamentos

| Referencia | Medidas | Cantidad |
|------------|---------|----------|
| 20CCEVW138 | 17 cm | 12 |



Plato 3 departamentos

| Referencia | Medidas | Cantidad |
|------------|---------|----------|
| 20CCEVW137 | 14 cm | 12 |

Ensaladeras

Ensaladera Polaris

| Referencia | Medidas | Cantidad |
|------------|---------|----------|
| 50CCPWD126 | 26 cm Ø | 4 |
| 50CCPWD118 | 18 cm Ø | 12 |
| 50CCPWD114 | 14 cm Ø | 24 |

Ensaladera Fusión Salsa

| Referencia | Medidas | Cantidad |
|------------|---------|----------|
| 29CCFUS174 | 22 cm | 12 |
| 29CCFUS173 | 18 cm | 12 |
| 29CCFUS172 | 14 cm | 24 |
| 29CCFUS171 | 10 cm | 24 |

Ensaladera Fusión Soy

| Referencia | Medidas | Cantidad |
|------------|---------|----------|
| 29CCFUS184 | 22 cm Ø | 12 |
| 29CCFUS183 | 18 cm Ø | 12 |
| 29CCFUS182 | 14 cm Ø | 24 |
| 29CCFUS181 | 10 cm Ø | 24 |

Bol Salsa

| Referencia | Capacidad | Cantidad |
|------------|-----------|----------|
| 50CCPWD047 | 23 cl | 12 |
| 50CCPWD048 | 15 cl | 12 |
| 50CCPWD046 | 7,5 cl | 24 |



Tacerío

Continental



Taza Polaris

| Referencia | Capacidad | Cantidad |
|------------|-----------|----------|
| 51CCPWD035 | 20 cl | 24 |
| 51CCPWD031 | 18 cl | 24 |
| 51CCPW0036 | 10 cl | 24 |



Taza Capuccino

| Referencia | Capacidad | Cantidad |
|------------|-----------|----------|
| 51CCPWD030 | 30 cl | 24 |
| 51CCPWD038 | 23 cl | 24 |
| 51CCPWD034 | 7,5 cl | 24 |



Taza Montblanc

| Referencia | Capacidad | Cantidad |
|------------|-----------|----------|
| 66CCMOB037 | 20 cl | 24 |
| 66CCMOB031 | 18 cl | 24 |
| 66CCMOB036 | 10 cl | 24 |



Taza Everest

| Referencia | Capacidad | Cantidad |
|------------|-----------|----------|
| 66CCMOB037 | 20 cl | 24 |
| 66CCMOB031 | 18 cl | 24 |
| 66CCMOB036 | 10 cl | 24 |



Platillo Polaris

| Referencia | Medidas | Cantidad |
|------------|---------|----------|
| 51CCPWD007 | 15 cm | 24 |
| 51CCPWD033 | 12 cm | 24 |



Platillo Capuccino

| Referencia | Medidas | Cantidad |
|------------|---------|----------|
| 51CCPWD007 | 15 cm | 24 |
| 51CCPWD033 | 12 cm | 24 |



Platillo Montblanc

| Referencia | Medidas | Cantidad |
|------------|---------|----------|
| 66CCMOB307 | 15 cm | 24 |
| 66CCMOB008 | 12 cm | 24 |



Platillo Everest

| Referencia | Medidas | Cantidad |
|------------|---------|----------|
| 21CCEVE307 | 15 cm | 24 |
| 21CCEVE008 | 12 cm | 24 |

Everest

Plato llano

| Referencia | Medidas | Cantidad |
|------------|---------|----------|
| 21CCEVE196 | 31 cm Ø | 12 |
| 21CCEVE102 | 29 cm Ø | 12 |
| 21CCEVE101 | 27 cm Ø | 24 |
| 21CCEVE001 | 25 cm Ø | 24 |
| 21CCEVE302 | 23 cm Ø | 24 |
| 21CCEVE009 | 20 cm Ø | 24 |
| 21CCEVE004 | 17 cm Ø | 24 |



Plato hondo/pasta

| Referencia | Medidas | Cantidad |
|------------|---------|----------|
| 21CCEVE103 | 28 cm Ø | 12 |
| 21CCEVE104 | 26 cm Ø | 12 |
| 21CCEVE005 | 23 cm Ø | 24 |



Continental

Mont Blanc

Plato llano

| Referencia | Medidas | Cantidad |
|------------|---------|----------|
| 66CCMOB196 | 31 cm Ø | 12 |
| 66CCMOB102 | 29 cm Ø | 12 |
| 66CCMOB101 | 27 cm Ø | 24 |
| 66CCMOB001 | 25 cm Ø | 24 |
| 66CCMOB302 | 23 cm Ø | 24 |
| 66CCMOB009 | 20 cm Ø | 24 |
| 66CCMOB004 | 17 cm Ø | 24 |



Plato hondo/pasta

| Referencia | Medidas | Cantidad |
|------------|---------|----------|
| 66CCMOB103 | 28 cm Ø | 12 |
| 66CCMOB104 | 26 cm Ø | 12 |
| 66CCMOB005 | 23 cm Ø | 24 |



Fuente oval ala ancha

| Referencia | Medidas | Cantidad |
|------------|---------|----------|
| 66CCMOB079 | 30 cm | 12 |



Bistro



Fuente recta

| Referencia | Medidas | Cantidad |
|------------|----------|----------|
| 33RECT203 | 33x20 cm | 12 |
| 33RECT202 | 28x16 cm | 12 |
| 33RECT201 | 26x16 cm | 12 |
| 33RECT204 | 36x16 cm | 12 |
| 33RECT205 | 26x26 cm | 12 |



Fuente curva

| Referencia | Medidas | Cantidad |
|------------|----------|----------|
| 32CURV193 | 35x20 cm | 12 |
| 32CURV192 | 36x15 cm | 12 |
| 32CURV194 | 28x16 cm | 12 |
| 32CURV191 | 36x10 cm | 12 |

Continental

Pebble



Plato llano

| Referencia | Medidas | Cantidad |
|------------|----------|----------|
| 30PEB231 | 31x28 cm | 12 |
| 30PEB233 | 25x21 cm | 12 |
| 30PEB234 | 20x18 cm | 12 |



Plato hondo

| Referencia | Medidas | Cantidad |
|------------|----------|----------|
| 30PEB232 | 27x24 cm | 12 |



White-01



Light Green-02



Blue-03



Terracota-04



Dark Green-05

Rustics White



Continental

Ensaladera Fusión Salsa



| Referencia | Medidas | Cantidad |
|---------------|---------|----------|
| 29CCFUS174-01 | 22 cm | 12 |
| 29CCFUS173-01 | 18 cm | 12 |
| 29CCFUS172-01 | 14 cm | 24 |
| 29CCFUS171-01 | 10 cm | 24 |



Fuente recta

| Referencia | Medidas | Cantidad |
|--------------|----------|----------|
| 33RECT204-01 | 36x16 cm | 12 |
| 33RECT203-01 | 33x20 cm | 12 |
| 33RECT202-01 | 28x16 cm | 12 |
| 33SQU205-01 | 26x26 cm | 12 |



Fuente curva

| Referencia | Medidas | Cantidad |
|--------------|----------|----------|
| 33CURV193-01 | 36x20 cm | 12 |
| 33CURV192-01 | 36x15 cm | 12 |
| 33CURV191-01 | 36x10 cm | 12 |

Plato llano Coupe



| Referencia | Medidas | Cantidad |
|-------------|---------|----------|
| 29FUS335-01 | 29 cm Ø | 12 |
| 29FUS334-01 | 27 cm Ø | 12 |
| 29FUS332-01 | 23 cm Ø | 12 |
| 29FUS331-01 | 19 cm Ø | 12 |

Plato hondo Coupe



| Referencia | Medidas | Cantidad |
|-------------|-----------|----------|
| 29FUS343-01 | 29 cm Ø | 12 |
| 29FUS342-01 | 24,5 cm Ø | 12 |
| 29FUS341-01 | 20 cm Ø | 12 |

Plato Pebble llano



| Referencia | Medidas | Cantidad |
|-------------|----------|----------|
| 30PEB231-01 | 31x28 cm | 12 |
| 30PEB233-01 | 25x21 cm | 12 |
| 30PEB234-01 | 20x18 cm | 12 |

Plato hondo



| Referencia | Medidas | Cantidad |
|-------------|----------|----------|
| 30PEB232-01 | 27x24 cm | 12 |



Bol

| Referencia | Medidas | Cantidad |
|-------------|---------|----------|
| 20RUS047-01 | 12,5 cm | 12 |



Taza Capuccino

| Referencia | Capacidad | Cantidad |
|-------------|-----------|----------|
| 51RUS030-01 | 30 cl | 24 |
| 51RUS038-01 | 23 cl | 24 |
| 51RUS034-01 | 7,5 cl | 24 |



Plato llano Coupe

| Referencia | Medidas | Cantidad |
|-------------|---------|----------|
| 29FUS335-04 | 29 cm Ø | 12 |
| 29FUS334-04 | 27 cm Ø | 12 |
| 29FUS332-04 | 23 cm Ø | 12 |
| 29FUS331-04 | 19 cm Ø | 12 |



Plato hondo Coupe

| Referencia | Medidas | Cantidad |
|-------------|-----------|----------|
| 29FUS343-04 | 29 cm Ø | 12 |
| 29FUS342-04 | 24,5 cm Ø | 12 |
| 29FUS341-04 | 20 cm Ø | 12 |



Plato Pebble llano

| Referencia | Medidas | Cantidad |
|-------------|----------|----------|
| 30PEB231-04 | 31x28 cm | 12 |
| 30PEB233-04 | 25x21 cm | 12 |
| 30PEB234-04 | 20x18 cm | 12 |



Plato hondo

| Referencia | Medidas | Cantidad |
|-------------|----------|----------|
| 30PEB232-04 | 27x24 cm | 12 |

Ensaladera Fusión Salsa



| Referencia | Medidas | Cantidad |
|---------------|---------|----------|
| 29CCFUS174-04 | 22 cm | 12 |
| 29CCFUS173-04 | 18 cm | 12 |
| 29CCFUS172-04 | 14 cm | 24 |
| 29CCFUS171-04 | 10 cm | 24 |

Fuente recta



| Referencia | Medidas | Cantidad |
|--------------|----------|----------|
| 33RECT204-04 | 36x16 cm | 12 |
| 33RECT203-04 | 33x20 cm | 12 |
| 33RECT202-04 | 28x16 cm | 12 |
| 33SQU205-04 | 26x26 cm | 12 |

Fuente curva



| Referencia | Medidas | Cantidad |
|--------------|----------|----------|
| 33CURV193-04 | 36x20 cm | 12 |
| 33CURV192-04 | 36x15 cm | 12 |
| 33CURV191-04 | 36x10 cm | 12 |

Bol



| Referencia | Medidas | Cantidad |
|-------------|---------|----------|
| 20RUS047-04 | 12,5 cm | 12 |



Taza Capuccino

| Referencia | Capacidad | Cantidad |
|-------------|-----------|----------|
| 51RUS030-04 | 30 cl | 24 |
| 51RUS038-04 | 23 cl | 24 |
| 51RUS034-04 | 7,5 cl | 24 |

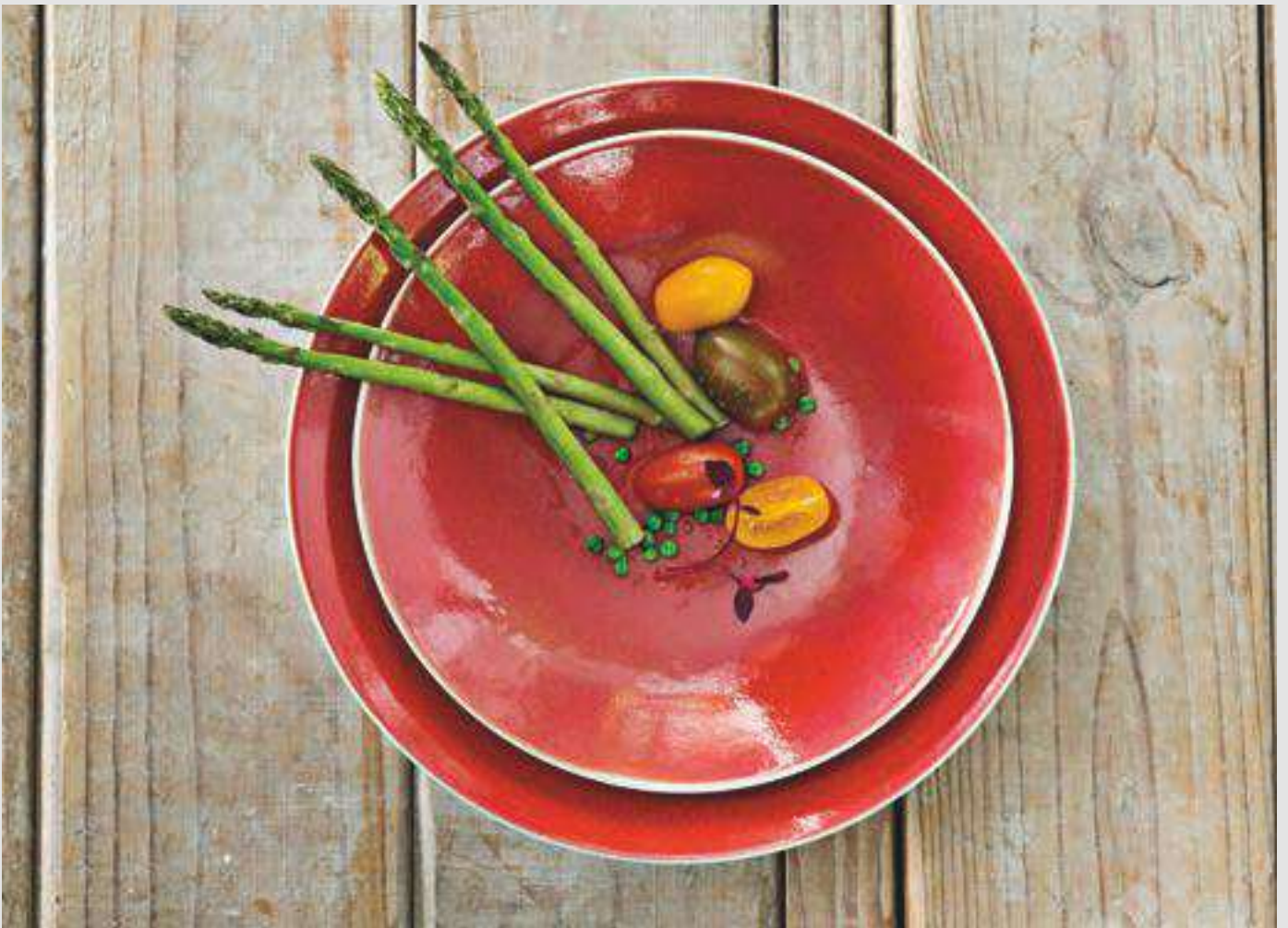

Reactivos



Lava-21



Turquoise-22



Purple-24



Red-41



Yellow-42



Lime-43



Orange-44

Plato llano Coupe

| Referencia | Medidas | Cantidad | |
|------------|---------|----------|----------------------|
| 29FUS331 | 19 cm Ø | 24 | 21-22-41-42 |
| 29FUS332 | 23 cm Ø | 24 | 21-22-41 |
| 29FUS334 | 27 cm Ø | 24 | 21-22-24-41-42 |
| 29FUS335 | 29 cm Ø | 12 | 21-22-24-41-42-43-44 |

Plato hondo Coupe

| Referencia | Medidas | Cantidad | |
|------------|-----------|----------|----------------|
| 29FUS342 | 24,5 cm Ø | 24 | 21-22-41-42-44 |
| 29FUS343 | 29 cm Ø | 12 | 21-22-41-42-44 |



Plato Pebble llano

| Referencia | Medidas | Cantidad | |
|------------|------------|----------|-------|
| 30PEB231 | 31x28 cm Ø | 12 | 22-41 |
| 30PEB233 | 25x21 cm Ø | 24 | 22-41 |
| 30PEB234 | 20x18 cm Ø | 24 | 22-41 |



Fuente recta

| Referencia | Medidas | Cantidad | |
|------------|------------|----------|-------------------|
| 33RECT201 | 26x16 cm Ø | 12 | 21-22-24-41-42-43 |
| 33RECT204 | 36x16 cm Ø | 12 | 21-22-41-42-43 |

Fuente curva

| Referencia | Medidas | Cantidad | |
|------------|-------------|----------|----------------|
| 32CURV191 | 36x9,5 cm Ø | 12 | 22-41 |
| 32CURV192 | 36x15 cm Ø | 12 | 21-22-41-42-43 |
| 32CURV193 | 35x19 cm Ø | 12 | 41-42-43 |

Continental



Bol salsa

| Referencia | Medidas | Cantidad | |
|------------|---------|----------|----------------|
| 29FUS171 | 10 cm | 24 | 21-22-41-42-43 |
| 29FUS172 | 14 cm | 24 | 21-22-41-42-43 |
| 29FUS174 | 22 cm | 12 | 21-22-41-42 |

Venus



Plato llano

| Referencia | Medidas | Cantidad |
|------------|---------|----------|
| V015DU00 | 15 cm Ø | 12 |
| V018DU00 | 18 cm Ø | 12 |
| V020DU00 | 20 cm Ø | 12 |
| V024DU00 | 24 cm Ø | 12 |
| V026DU00 | 26 cm Ø | 12 |
| V028DU00 | 28 cm Ø | 6 |
| V032DU00 | 32 cm Ø | 6 |



Plato hondo

| Referencia | Medidas | Cantidad |
|------------|---------|----------|
| V022CK00 | 22 cm Ø | 12 |



Fuente oval

| Referencia | Medidas | Cantidad |
|------------|----------|----------|
| V021KY00 | 21x15 cm | 6 |
| V025KY00 | 25x18 cm | 6 |
| V028KY00 | 28x20 cm | 6 |
| V032KY00 | 32x23 cm | 6 |
| V035KY00 | 35x25 cm | 6 |
| V039KY00 | 39x28 cm | 6 |



Bol apilable

| Referencia | Medidas | Capacidad | Cantidad |
|------------|---------|-----------|----------|
| E006JK00 | 6 cm Ø | 4 cl | 24 |
| E008JK00 | 8 cm Ø | 9 cl | 24 |
| E010JK00 | 10 cm Ø | 18 cl | 24 |
| E012JK00 | 12 cm Ø | 38 cl | 12 |
| E014JK00 | 14 cm Ø | 66 cl | 12 |
| E016JK00 | 16 cm Ø | 98 cl | 6 |



Bol

| Referencia | Medidas | Cantidad |
|------------|---------|----------|
| ED15KK00 | 15 cm Ø | 12 |
| ED19KK00 | 19 cm Ø | 12 |
| ED25KK00 | 25 cm Ø | 6 |



Taza c/plato

| Referencia | Capacidad | Cantidad |
|------------|-----------|----------|
| V002KT00 | 9 cl | 12 |
| V0023C00 | 17 cl | 12 |
| V002CT00 | 23 cl | 12 |



Plato llano

| Referencia | Medidas | Cantidad |
|------------|---------|----------|
| D116DU00 | 16 cm Ø | 12 |
| D117DU00 | 17 cm Ø | 12 |
| D118DU00 | 18 cm Ø | 12 |
| D120DU00 | 20 cm Ø | 12 |
| D122DU00 | 22 cm Ø | 12 |
| D124DU00 | 24 cm Ø | 12 |
| D126DU00 | 26 cm Ø | 12 |
| D127DU00 | 27 cm Ø | 12 |
| D128DU00 | 28 cm Ø | 6 |
| D130DU00 | 30 cm Ø | 6 |
| D132DU00 | 32 cm Ø | 6 |

Plato hondo

| Referencia | Medidas | Cantidad |
|------------|---------|----------|
| D122CK00 | 22 cm Ø | 12 |
| D123CK00 | 23 cm Ø | 12 |

Fuente oval

| Referencia | Medidas | Cantidad |
|------------|----------|----------|
| DD21KY00 | 21x14 cm | 6 |
| DD25KY00 | 24x17 cm | 6 |
| DD29KY00 | 29x20 cm | 6 |
| DD34KY00 | 34x24 cm | 6 |
| DD39KY00 | 39x27 cm | 6 |

Bol apilable

| Referencia | Medidas | Capacidad | Cantidad |
|------------|---------|-----------|----------|
| E006JK00 | 6 cm Ø | 4 cl | 24 |
| E008JK00 | 8 cm Ø | 9 cl | 24 |
| E010JK00 | 10 cm Ø | 18 cl | 24 |
| E012JK00 | 12 cm Ø | 38 cl | 12 |
| E014JK00 | 14 cm Ø | 66 cl | 12 |
| E016JK00 | 16 cm Ø | 98 cl | 6 |

Bol

| Referencia | Medidas | Cantidad |
|------------|---------|----------|
| E014KK00 | 14 cm Ø | 12 |
| E019KK00 | 19 cm Ø | 12 |
| GR23KK00 | 23 cm Ø | 6 |

Taza c/plato

| Referencia | Capacidad | Cantidad |
|------------|-----------|----------|
| E002KT00 | 6 cl | 12 |
| E002EK00 | 9 cl | 12 |
| E002NT00 | 14 cl | 12 |
| E0023C00 | 17 cl | 12 |
| E002CT00 | 23 cl | 12 |



Plato llano

| Referencia | Medidas | Cantidad |
|------------|---------|----------|
| EO15DU00 | 15 cm Ø | 12 |
| EO17DU00 | 17 cm Ø | 12 |
| EO19DU00 | 19 cm Ø | 12 |
| EO21DU00 | 21 cm Ø | 12 |
| EO23DU00 | 23 cm Ø | 12 |
| EO25DU00 | 25 cm Ø | 12 |
| EO27DU00 | 27 cm Ø | 12 |
| EO28DU00 | 28 cm Ø | 6 |
| EO30DU00 | 30 cm Ø | 6 |

Bol

| Referencia | Medidas | Cantidad |
|------------|---------|----------|
| EO14KK00 | 14 cm Ø | 12 |
| EO19KK00 | 19 cm Ø | 12 |
| GR23KK00 | 23 cm Ø | 6 |

Bol apilable

| Referencia | Medidas | Capacidad | Cantidad |
|------------|---------|-----------|----------|
| E006JK00 | 6 cm Ø | 4 cl | 24 |
| E008JK00 | 8 cm Ø | 9 cl | 24 |
| E010JK00 | 10 cm Ø | 18 cl | 24 |
| E012JK00 | 12 cm Ø | 38 cl | 12 |
| E014JK00 | 14 cm Ø | 66 cl | 12 |
| E016JK00 | 16 cm Ø | 98 cl | 6 |

Plato hondo

| Referencia | Medidas | Cantidad |
|------------|---------|----------|
| EO20CK00 | 20 cm Ø | 12 |

Fuente oval

| Referencia | Medidas | Cantidad |
|------------|----------|----------|
| EO15KY00 | 15x9 cm | 12 |
| EO19KY00 | 19x11 cm | 6 |
| EO24KY00 | 24x14 cm | 6 |
| EO26KY00 | 26x15 cm | 6 |
| EO29KY00 | 29x17 cm | 6 |
| EO34KY00 | 34x20 cm | 6 |
| EO39KY00 | 39x24 cm | 6 |

Taza c/plato

| Referencia | Capacidad | Cantidad |
|------------|-----------|----------|
| E002KT00 | 6 cl | 12 |
| E002EK00 | 9 cl | 12 |
| E002NT00 | 14 cl | 12 |
| E0023C00 | 17 cl | 12 |
| E002CT00 | 23 cl | 12 |



Plato llano

| Referencia | Medidas | Cantidad |
|------------|----------|----------|
| MMZ18DU00 | 16x16 cm | 12 |
| MMZ21DU00 | 18x18 cm | 12 |
| MMZ25DU00 | 22x22 cm | 12 |
| MMZ27DU00 | 23x23 cm | 12 |
| MMZ29DU00 | 25x25 cm | 12 |
| MMZ32DU00 | 28x28 cm | 6 |
| MMZ35DU00 | 30x30 cm | 6 |

Bol

| Referencia | Medidas | Cantidad |
|------------|----------|----------|
| MMZ16KK00 | 14x14 cm | 12 |
| MMZ19KK00 | 17x17 cm | 12 |
| MMZ25KK00 | 21x21 cm | 6 |

Plato hondo

| Referencia | Medidas | Cantidad |
|------------|----------|----------|
| MMZ21CK00 | 18x18 cm | 12 |
| MMZ22CK00 | 19x19 cm | 12 |

Bol apilable

| Referencia | Medidas | Capacidad | Cantidad |
|------------|---------|-----------|----------|
| MRS06JK00 | 6 cm Ø | 4 cl | 12 |
| MRS10JK00 | 10 cm Ø | 20 cl | 12 |
| MRS12JK00 | 12 cm Ø | 35 cl | 12 |

Fuente oval

| Referencia | Medidas | Cantidad |
|------------|----------|----------|
| MMZ19KY00 | 19x13 cm | 6 |
| MMZ24KY00 | 24x16 cm | 6 |
| MMZ29KY00 | 29x19 cm | 6 |
| MMZ34KY00 | 34x23 cm | 6 |
| MMZ39KY00 | 39x26 cm | 6 |

Taza c/plato

| Referencia | Capacidad | Cantidad |
|------------|-----------|----------|
| MMZ02KT00 | 7 cl | 12 |
| MMZ02EK00 | 9 cl | 12 |
| MMZ023C00 | 17 cl | 12 |
| MMZ02CT00 | 23 cl | 12 |

Estambul



Plato llano

| Referencia | Medidas | Cantidad |
|------------|---------|----------|
| XT14DU00 | 14 cm Ø | 12 |
| XT17DU00 | 17 cm Ø | 12 |
| XT19DU00 | 19 cm Ø | 12 |
| XT21DU00 | 21 cm Ø | 12 |
| XT23DU00 | 23 cm Ø | 12 |
| XT25DU00 | 25 cm Ø | 12 |
| XT27DU00 | 27 cm Ø | 12 |
| XT30DU00 | 30 cm Ø | 6 |
| XT32DU00 | 32 cm Ø | 6 |

Plato hondo

| Referencia | Medidas | Cantidad |
|------------|---------|----------|
| XT22CK00 | 22 cm Ø | 12 |

Fuente oval

| Referencia | Medidas | Cantidad |
|------------|----------|----------|
| XT20KY00 | 20x16 cm | 6 |
| XT24KY00 | 24x19 cm | 6 |
| XT29KY00 | 29x23 cm | 6 |
| XT34KY00 | 34x27 cm | 6 |
| XT39KY00 | 39x31 cm | 6 |

Bol

| Referencia | Medidas | Cantidad |
|------------|---------|----------|
| XT15KK00 | 15 cm Ø | 12 |
| XT19KK00 | 19 cm Ø | 12 |
| XT25KK00 | 25 cm Ø | 6 |

Bol apilable

| Referencia | Medidas | Capacidad | Cantidad |
|------------|---------|-----------|----------|
| XT06JK00 | 6 cm Ø | 4 cl | 24 |
| XT08JK00 | 8 cm Ø | 9 cl | 24 |
| XT10JK00 | 10 cm Ø | 18 cl | 24 |
| XT12JK00 | 12 cm Ø | 38 cl | 12 |

Taza c/plato

| Referencia | Capacidad | Cantidad |
|------------|-----------|----------|
| XT02KT00 | 9 cl | 12 |
| XT02NT00 | 14 cl | 12 |
| XT023C00 | 17 cl | 12 |
| XT02CT00 | 23 cl | 12 |

GÜRÜL PORSELEN
"Dünyanın Porseleni"



Plato llano gourmet

| Referencia | Medidas | Cantidad |
|------------|---------|----------|
|------------|---------|----------|

| | | |
|------------|---------|---|
| MDR29GDU00 | 29 cm Ø | 6 |
| MDR31GDU00 | 32 cm Ø | 6 |



Platos Especiales



Delta plato pasta

| Referencia | Medidas | Cantidad |
|------------|---------|----------|
|------------|---------|----------|

| | | |
|----------|---------|---|
| D127CK00 | 27 cm Ø | 6 |
| D130CK00 | 30 cm Ø | 6 |



Reno plato pasta

| Referencia | Medidas | Cantidad |
|------------|---------|----------|
|------------|---------|----------|

| | | |
|----------|---------|---|
| RN26CK00 | 26 cm Ø | 6 |
| RN30CK00 | 30 cm Ø | 6 |



Estambul plato pasta

| Referencia | Medidas | Cantidad |
|------------|---------|----------|
|------------|---------|----------|

| | | |
|----------|---------|---|
| XT30CK00 | 30 cm Ø | 6 |
|----------|---------|---|



Plato pizza

| Referencia | Medidas | Cantidad |
|------------|---------|----------|
|------------|---------|----------|

| | | |
|----------|---------|---|
| D128PT00 | 28 cm Ø | 6 |
| D130PT00 | 30 cm Ø | 6 |
| D133PT00 | 33 cm Ø | 6 |

GÜRÜL PORSELEN
"Dünyanın Porseleni"



Plato Steak

| Referencia | Medidas | Cantidad |
|------------|---------|----------|
|------------|---------|----------|

| | | |
|----------|---------|---|
| D129IZ00 | 29 cm Ø | 6 |
|----------|---------|---|

Colorado-Rojo



Plato llano

| Referencia | Medidas | Cantidad |
|--------------|----------|----------|
| NBNKL17X17DU | 17x17 cm | 12 |
| NBNKL19X19DU | 19x19 cm | 12 |
| NBNKL22X22DU | 22x22 cm | 12 |
| NBNKL25X25DU | 17x17 cm | 12 |



Plato hondo

| Referencia | Medidas | Cantidad |
|--------------|----------|----------|
| NBNKL25X25CK | 19x19 cm | 12 |



Fuente rectangular

| Referencia | Medidas | Cantidad |
|--------------|----------|----------|
| NBNKL24X14KY | 24x14 cm | 6 |
| NBNKL29X17KY | 24x14 cm | 6 |



Bol

| Referencia | Medidas | Cantidad |
|--------------|----------|----------|
| NBNKL15X15KK | 15x15 cm | 6 |
| NBNKL15X15KK | 17x17 cm | 6 |



Bol apilable

| Referencia | Medidas | Cantidad |
|------------|---------|----------|
| NBNMRS06JK | 6 cm Ø | 24 |
| NBNMRS10JK | 10 cm Ø | 24 |
| NBNMRS12JK | 12 cm Ø | 12 |

GÜRAL PORSELEN
"Dünyanın Porseleni"



Taza c/plato

| Referencia | Capacidad | Cantidad |
|-------------|-----------|----------|
| NBKL90KFT | 9 cl | 12 |
| NBKL170CKFT | 17 cl | 12 |
| NBKL230CKFT | 23 cl | 12 |

Otros colores disponibles



Marrón



Natural



Antracita



Verde



Tierra



Turquesa



Plato llano

| Referencia | Medidas | Cantidad |
|------------|---------|----------|
| NBNEO15DU | 15 cm Ø | 12 |
| NBNEO17DU | 17 cm Ø | 12 |
| NBNEO19DU | 19 cm Ø | 12 |
| NBNEO21DU | 21 cm Ø | 12 |
| NBNEO23DU | 23 cm Ø | 12 |
| NBNEO25DU | 25 cm Ø | 12 |
| NBNEO27DU | 27 cm Ø | 12 |
| NBNEO28DU | 28 cm Ø | 6 |
| NBNEO30DU | 30 cm Ø | 6 |



Plato hondo

| Referencia | Medidas | Cantidad |
|------------|---------|----------|
| NBNEO20CK | 20 cm Ø | 12 |



Fuente rectangular

| Referencia | Medidas | Cantidad |
|------------|----------|----------|
| NBNEO15KY | 15x9 cm | 12 |
| NBNEO19KY | 19x11 cm | 12 |
| NBNEO24KY | 24x14 cm | 6 |
| NBNEO26KY | 26x15 cm | 6 |
| NBNEO29KY | 29x17 cm | 6 |
| NBNEO34KY | 34x20 cm | 6 |
| NBNEO39KY | 34x24 cm | 6 |

GÜRAL PORSELEN
"Dünyanın Porseleni"



Bol

| Referencia | Medidas | Cantidad |
|------------|---------|----------|
| NBNEO14KK | 14 cm Ø | 12 |
| NBNEO19KK | 19 cm Ø | 12 |
| NBNEO23KK | 23 cm Ø | 6 |



Bol apilable

| Referencia | Medidas | Cantidad |
|------------|---------|----------|
| NBNEO06JK | 6 cm Ø | 24 |
| NBNEO08JK | 8 cm Ø | 24 |
| NBNEO10JK | 10 cm Ø | 24 |
| NBNEO12JK | 12 cm Ø | 12 |
| NBNEO14JK | 14 cm Ø | 6 |
| NBNEO16JK | 16 cm Ø | 6 |
| NBNEO22JK | 22 cm Ø | 6 |



Taza c/plato

| Referencia | Capacidad | Cantidad |
|------------|-----------|----------|
| NBNEO02KT | 6 cl | 12 |
| NBNEO02EKT | 9 cl | 12 |
| NBNEO02NT | 14 cl | 12 |
| NBNEO023C | 17 cl | 12 |
| NBNEO02CT | 23 cl | 12 |

Otros colores disponibles



Marrón

Natural

Rojo

Verde

Tierra

Turquesa

Ming



Plato llano

| Referencia | Medidas | Cantidad |
|------------|----------|----------|
| B1536 | 41x41 cm | 2 |
| B1535 | 35x35 cm | 4 |
| B1277 | 31x31 cm | 4 |
| B1224 | 27x27 cm | 4 |
| B1157 | 24x24 cm | 6 |
| B1637 | 21x21 cm | 6 |
| B1156 | 19x19 cm | 6 |
| B2079 | 16x16 cm | 6 |
| B2078 | 12x12 cm | 6 |
| B2977 | 9x9 cm | 12 |
| B2076 | 7x7 cm | 12 |



Plato hondo

| Referencia | Medidas | Cantidad |
|------------|----------|----------|
| B1225 | 20x20 cm | 6 |



Plato rectangular

| Referencia | Medidas | Cantidad |
|------------|----------|----------|
| B2492 | 28x24 cm | 6 |
| B2393 | 24x20 cm | 6 |
| B2494 | 19x16 cm | 6 |



Bol

| Referencia | Medidas | Cantidad |
|------------|--------------|----------|
| B1424 | 16x16x16 cm | 6 |
| B1226 | 13x13x4,5 cm | 6 |
| B2499 | 10x10x6 cm | 6 |
| B1255 | 8x8x4 cm | 6 |
| B1425 | 6,5x6,5x3 cm | 6 |



Bandeja estrecha

| Referencia | Medidas | Cantidad |
|------------|----------|----------|
| B2539 | 30x12 cm | 6 |
| B2599 | 28x16 cm | 6 |
| B1864 | 24x9 cm | 6 |
| B2540 | 23x12 cm | 6 |
| B2541 | 20x12 cm | 6 |



Bandeja baguette

| Referencia | Medidas | Cantidad |
|------------|---------|----------|
| B2412 | 30x8 cm | 6 |
| B2413 | 25x8 cm | 6 |
| B2414 | 20x9 cm | 6 |



Bol c/pie

| Referencia | Medidas | Cantidad |
|------------|-----------|----------|
| B2103 | 11x11x3cm | 6 |
| B2104 | 7x7x2 cm | 6 |



Ensaladera

| Referencia | Medidas | Cantidad |
|------------|------------|----------|
| B2561 | 25x25x11cm | 3 |
| B1275 | 20x20x9 cm | 3 |



Fuente rectangular

| Referencia | Medidas | Cantidad |
|------------|----------|----------|
| B1623 | 46x28 cm | 3 |
| B1278 | 39x25 cm | 4 |

Ming II - Stoneware



Plato llano

| Referencia | Medidas | Cantidad |
|------------|----------|----------|
| B2771 | 26x26 cm | 6 |
| B2977 | 24x24 cm | 6 |
| B2978 | 21x21 cm | 6 |
| B2772 | 18x18 cm | 4 |
| B758010 | 16x16 cm | 6 |



Fuente rectangular

| Referencia | Medidas | Cantidad |
|------------|----------|----------|
| B2773 | 34x22 cm | 1 |
| B2883 | 30x20 cm | 6 |
| B2976 | 30x15 cm | 6 |
| B2774 | 25x15 cm | 6 |
| B758011 | 20x13 cm | 6 |
| B758012 | 30x8 cm | 1 |



Fuente rectangular Boa

| Referencia | Medidas | Cantidad |
|------------|----------|----------|
| B2995 | 30x20 cm | 6 |
| B3300 | 30x15 cm | 6 |
| B3306 | 25x15 cm | 6 |



Ensaladera

| Referencia | Medidas | Cantidad |
|------------|------------|----------|
| B2775 | 22x22x9cm | 6 |
| B758013 | 13x13x5 cm | 6 |

Otros colores disponibles



Blanco



Crema



The Reserve Stoneware



Plato llano

| Referencia | Medidas | Cantidad |
|------------|---------|----------|
| BLANCO | | |
| B2958 | 30 cm Ø | 6 |
| B2959 | 27 cm Ø | 6 |
| B2979 | 25 cm Ø | 6 |
| B2960 | 21 cm Ø | 6 |
| NEGRO | | |
| B2964 | 30 cm Ø | 6 |
| B2965 | 27 cm Ø | 6 |
| B2980 | 25 cm Ø | 6 |
| B2966 | 21 cm Ø | 6 |



Ensaladera

| Referencia | Medidas | Cantidad |
|------------|---------|----------|
| BLANCO | | |
| B2962 | 24 cm Ø | 6 |
| B2963 | 17 cm Ø | 6 |
| NEGRO | | |
| B2968 | 24 cm Ø | 6 |
| B2969 | 17 cm Ø | 6 |



Plato hondo

| Referencia | Medidas | Cantidad |
|------------|---------|----------|
| BLANCO | | |
| B2961 | 23 cm Ø | 6 |
| NEGRO | | |
| B2967 | 23 cm Ø | 6 |



Plato pasta

| Referencia | Medidas | Cantidad |
|------------|---------|----------|
| BLANCO | | |
| B758027 | 29 cm Ø | 6 |
| NEGRO | | |
| B758034 | 29 cm Ø | 6 |



Plato pizza

| Referencia | Medidas | Cantidad |
|------------|---------|----------|
| BLANCO | | |
| B758040 | 33 cm Ø | 6 |
| B758041 | 30 cm Ø | 6 |
| NEGRO | | |
| B758042 | 33 cm Ø | 6 |
| B758043 | 30 cm Ø | 6 |



Ipec-Muga Stoneware



Plato llano Ming II

| Referencia | Medidas | Cantidad |
|------------|----------|----------|
| B758083 | 26x26 cm | 6 |
| B758084 | 24x24 cm | 6 |
| B758085 | 21x21 cm | 6 |
| B758086 | 18x18 cm | 6 |
| B758087 | 16x16 cm | 12 |



Plato llano Infinity

| Referencia | Medidas | Cantidad |
|------------|---------|----------|
| B758095 | 32 cm Ø | 6 |
| B758096 | 26 cm Ø | 6 |
| B758097 | 20 cm Ø | 12 |



Plato hondo Ming II

| Referencia | Medidas | Cantidad |
|------------|----------|----------|
| B758088 | 18x18 cm | 6 |



Bol Infinity

| Referencia | Medidas | Cantidad |
|------------|-----------|----------|
| B758099 | 16,5 cm Ø | 12 |



Plato hondo Infinity

| Referencia | Medidas | Cantidad |
|------------|-----------|----------|
| B758098 | 19,5 cm Ø | 12 |



Bol Ming II

| Referencia | Medidas | Cantidad |
|------------|----------|----------|
| B758089 | 13x13 cm | 12 |



Bandeja Rect Ming II

| Referencia | Medidas | Cantidad |
|------------|----------|----------|
| B758090 | 34x22 cm | 1 |
| B758091 | 30x20 cm | 6 |
| B758092 | 30x15 cm | 6 |
| B758093 | 25x15 cm | 6 |
| B758094 | 20x13 cm | 12 |



Plato pizza The Reserve

| Referencia | Medidas | Cantidad |
|------------|-----------|----------|
| B758100 | 30,5 cm Ø | 6 |



Bol The Reserve

| Referencia | Medidas | Cantidad |
|------------|-----------|----------|
| B758101 | 17,5 cm Ø | 12 |



Colores disponibles



Kobe



Quay



Muga



Aqua



Plato llano

| Referencia | Medidas | Cantidad |
|------------|---------|----------|
| B928144 | 30 cm Ø | 6 |
| B928145 | 27 cm Ø | 12 |
| B928146 | 21 cm Ø | 12 |
| B928147 | 27 cm Ø | 12 |



Bandeja oval

| Referencia | Medidas | Cantidad |
|------------|----------|----------|
| B928132 | 31x24 cm | 6 |



Plato Rissoto

| Referencia | Medidas | Cantidad |
|------------|---------|----------|
| B928134 | 38 cm Ø | 6 |



Plato Pasta

| Referencia | Medidas | Cantidad |
|------------|---------|----------|
| B928218 | 30 cm Ø | 6 |
| B928135 | 27 cm Ø | 6 |



Ensaladera

| Referencia | Medidas | Cantidad |
|------------|---------|----------|
| B928217 | 22 cm Ø | 6 |
| B928221 | 18 cm Ø | 12 |
| B928215 | 14 cm Ø | 12 |



Ensaladera Gourmet

| Referencia | Medidas | Cantidad |
|------------|---------|----------|
| B928219 | 20 cm Ø | 6 |
| B928220 | 16 cm Ø | 12 |

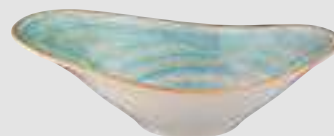

Bol oval

| Referencia | Medidas | Cantidad |
|------------|----------|----------|
| B928133 | 27x18 cm | 6 |



Fuente rectangular

| Referencia | Medidas | Cantidad |
|------------|----------|----------|
| B928214 | 23x16 cm | 12 |



Therapy



Plato llano

| Referencia | Medidas | Cantidad |
|------------|---------|----------|
| B928148 | 30 cm Ø | 6 |
| B928149 | 27 cm Ø | 12 |
| B928150 | 21 cm Ø | 12 |
| B928151 | 27 cm Ø | 12 |



Bandeja oval

| Referencia | Medidas | Cantidad |
|------------|----------|----------|
| B928136 | 31x24 cm | 6 |



Plato Rissoto

| Referencia | Medidas | Cantidad |
|------------|---------|----------|
| B928138 | 38 cm Ø | 6 |



Plato Pasta

| Referencia | Medidas | Cantidad |
|------------|---------|----------|
| B928226 | 30 cm Ø | 6 |
| B928139 | 27 cm Ø | 6 |



Ensaladera

| Referencia | Medidas | Cantidad |
|------------|---------|----------|
| B928225 | 22 cm Ø | 6 |
| B928229 | 18 cm Ø | 12 |
| B928223 | 14 cm Ø | 12 |



Ensaladera Gourmet

| Referencia | Medidas | Cantidad |
|------------|---------|----------|
| B928227 | 20 cm Ø | 6 |
| B928228 | 16 cm Ø | 12 |



Bol oval

| Referencia | Medidas | Cantidad |
|------------|----------|----------|
| B928137 | 27x18 cm | 6 |



Fuente rectangular

| Referencia | Medidas | Cantidad |
|------------|----------|----------|
| B928222 | 23x16 cm | 12 |



Africa

Borde liso - 0,6 mm espesor



Pizarra rectangular

| Referencia | Medidas | Cantidad |
|------------|----------|----------|
| B4003 | 40x13 cm | 6 |
| B2575 | 41x29 cm | 12 |
| B2792 | 40x25 cm | 12 |
| B2799 | 40x13 cm | 12 |
| B2576 | 37x18 cm | 12 |
| B2577 | 32x15 cm | 12 |
| B2794 | 30x20 cm | 12 |
| B2795 | 30x13 cm | 12 |
| B2797 | 25x13 cm | 24 |
| B2578 | 20x13 cm | 24 |
| B2579 | 13x9 cm | 48 |
| B2793 | 40x8 cm | 24 |
| B2796 | 30x8 cm | 24 |
| B2798 | 20x8 cm | 24 |

Pizarra cuadrada

| Referencia | Medidas | Cantidad |
|------------|----------|----------|
| B4008 | 34x34 cm | 6 |
| B2580 | 31x31 cm | 12 |
| B2800 | 29x29 cm | 12 |
| B2581 | 27x27 cm | 12 |
| B2582 | 25x25 cm | 12 |
| B2801 | 22x22 cm | 12 |
| B2583 | 20x20 cm | 12 |
| B2802 | 18x18 cm | 12 |
| B2584 | 15x15 cm | 24 |



Soft Africa

Borde irregular - 0,5 mm espesor



Pizarra rectangular

| Referencia | Medidas | Cantidad |
|------------|----------|----------|
| B839000 | 41x29 cm | 12 |
| B839001 | 37x18 cm | 12 |
| B839002 | 32x15 cm | 12 |
| B839003 | 20x13 cm | 12 |
| B839004 | 13x9 cm | 24 |
| B839009 | 40x25 cm | 12 |
| B839010 | 30x20 cm | 12 |
| B839011 | 30x13 cm | 12 |
| B839012 | 30x8 cm | 24 |
| B839013 | 25x13 cm | 24 |
| B839014 | 20x8 cm | 24 |
| B839017 | 53x32 cm | 6 |
| B839018 | 32x26 cm | 12 |
| B839019 | 32x17 cm | 12 |
| B839020 | 26x16 cm | 12 |
| B839021 | 53x16 cm | 12 |



Pizarra cuadrada

| Referencia | Medidas | Cantidad |
|------------|----------|----------|
| B839005 | 31x31 cm | 12 |
| B839006 | 27x27 cm | 12 |
| B839007 | 25x25 cm | 12 |
| B839015 | 22x22 cm | 12 |
| B839008 | 20x20 cm | 12 |
| B839016 | 18x18 cm | 12 |



Plato Bordeaux

| Referencia | Medidas | Cantidad |
|------------|---------|----------|
| B2569 | 31 cm Ø | 12 |
| B2570 | 28 cm Ø | 12 |
| B2571 | 24 cm Ø | 24 |
| B2572 | 20 cm Ø | 36 |
| B2573 | 15 cm Ø | 72 |
| B2574 | 10 cm Ø | 240 |

Plato Denia

| Referencia | Medidas | Cantidad |
|------------|---------|----------|
| B2632 | 28 cm Ø | 12 |
| B2633 | 25 cm Ø | 24 |
| B2634 | 20 cm Ø | 24 |

Plato Vecchio

| Referencia | Medidas | Cantidad |
|------------|---------|----------|
| B3428 | 29 cm Ø | 6 |
| B3429 | 26 cm Ø | 6 |
| B3430 | 21 cm Ø | 12 |

Plato Trattoria

| Referencia | Medidas | Cantidad |
|------------|---------|----------|
| B4123 | 30 cm Ø | 12 |
| B4124 | 24 cm Ø | 12 |
| B4125 | 18 cm Ø | 24 |

Bol Huitre

| Referencia | Medidas | Cantidad |
|------------|----------|----------|
| B1967 | 29x17 cm | 12 |
| B1968 | 19x11 cm | 24 |
| B1969R | 15x9 cm | 24 |

Bandeja Cairo

| Referencia | Medidas | Cantidad |
|------------|----------|----------|
| B2608 | 43x21 cm | 12 |
| B2609 | 38x18 cm | 12 |
| B2610 | 32x13 cm | 12 |
| B2611 | 25x10 cm | 12 |
| B2612 | 20x8 cm | 72 |

Bandeja Kayuko

| Referencia | Medidas | Cantidad |
|------------|----------|----------|
| B2486 | 40x18 cm | 12 |
| B2487 | 35x15 cm | 24 |
| B2488 | 30x13 cm | 36 |
| B2489 | 20x9 cm | 72 |

Bandeja Harvest

| Referencia | Medidas | Cantidad |
|------------|----------|----------|
| B3431 | 35x22 cm | 6 |
| B3432 | 30x20 cm | 6 |
| B3433 | 30x15 cm | 12 |
| B3434 | 25x15 cm | 12 |
| B3435 | 20x13 cm | 24 |

Bandeja Notte

| Referencia | Medidas | Cantidad |
|------------|----------|----------|
| B4177 | 35x25 cm | 12 |
| B4178 | 32x22 cm | 24 |
| B4179 | 26x18 cm | 24 |
| B4180 | 19x13 cm | 60 |
| B4181 | 14x10 cm | 120 |

Bandeja Altamira

| Referencia | Medidas | Cantidad |
|------------|----------|----------|
| B3421 | 45x14 cm | 6 |
| B3422 | 41x13 cm | 6 |
| B3423 | 35x12 cm | 6 |



Sprinkle



Plato presentación dec. ala

| Referencia | Medidas | Cantidad |
|------------|---------|----------|
| 21125250 | 33 cm Ø | 1 |



Plato presentación dec. centro

| Referencia | Medidas | Cantidad |
|------------|---------|----------|
| 21125251 | 33 cm Ø | 4 |

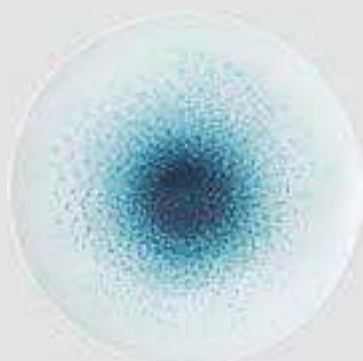

Plato llano

| Referencia | Medidas | Cantidad |
|------------|---------|----------|
| 21125252 | 28 cm Ø | 4 |
| 21125253 | 23 cm Ø | 4 |
| 21125254 | 20 cm Ø | 4 |



Bol sopa

| Referencia | Medidas | Capacidad | Cantidad |
|------------|---------|-----------|----------|
| 21125255 | 14 cm Ø | 54 cl | 4 |



Taza c/plato

| Referencia | Capacidad | Cantidad |
|------------|-----------|----------|
| 21125258 | 22 cl | 6 |
| 21125257 | 9 cl | 6 |



Bol arroz

| Referencia | Medidas | Capacidad | Cantidad |
|------------|---------|-----------|----------|
| 21125256 | 11 cm Ø | 33 cl | 4 |

Una decoración de carácter ligero y delicado, diseñada para enfatizar y elevar los mejores sabores.

Mandarín



Plato redondo

| Referencia | Medidas | Cantidad |
|------------|---------|----------|
| 21122810 | 28 cm Ø | 12 |
| 21123849 | 25 cm Ø | 12 |
| 21122812 | 23 cm Ø | 12 |



Plato cuadrado

| Referencia | Medidas | Cantidad |
|------------|----------|----------|
| 21122813 | 16x16 cm | 16 |



Plato mantequilla

| Referencia | Medidas | Cantidad |
|------------|---------|----------|
| 21122815 | 10 cm Ø | 6 |



Taza c/plato

| Referencia | Capacidad | Cantidad |
|------------|-----------|----------|
| 21123852 | 9 cl | 6 |

Con motivos y tonos armoniosos que reproducen el toque rústico de la pintura manual, la colección mandarín propone la relectura de algunas influencias asiáticas, destacando la sobriedad. Un conjunto que une las enseñanzas tradicionales a las tendencias actuales del diseño y de la decoración.



Fuente rectangular

| Referencia | Medidas | Cantidad |
|------------|----------|----------|
| 21122814 | 32x15 cm | 6 |



Bol sopa

| Referencia | Medidas | Capacidad | Cantidad |
|------------|----------|-----------|----------|
| 21122816 | 8,9 cm Ø | 26 cl | 6 |
| 21122818 | 7,7 cm Ø | 13 cl | 6 |
| 21122812 | 6,2 cm Ø | 9 cl | 12 |

Colores disponibles



Verde



Naranja



Gris



Verde Oscuro



Karma



Plato oval c/bol

| Referencia | Medidas | Cantidad |
|------------|---------|----------|
|------------|---------|----------|

| | | |
|----------|----------|---|
| 21108772 | 30x30 cm | 1 |
|----------|----------|---|



Plato llano

| Referencia | Medidas | Cantidad |
|------------|---------|----------|
|------------|---------|----------|

| | | |
|----------|---------|---|
| 21108765 | 28 cm Ø | 4 |
| 21108767 | 22 cm Ø | 4 |



Plato hondo

| Referencia | Medidas | Cantidad |
|------------|---------|----------|
|------------|---------|----------|

| | | |
|----------|---------|---|
| 21108766 | 27 cm Ø | 4 |
|----------|---------|---|



Bol

| Referencia | Medidas | Cantidad |
|------------|---------|----------|
|------------|---------|----------|

| | | |
|----------|---------|---|
| 21108770 | 17 cm Ø | 6 |
|----------|---------|---|



Taza c/plato

| Referencia | Capacidad | Cantidad |
|------------|-----------|----------|
|------------|-----------|----------|

| | | |
|----------|------|---|
| 21108771 | 9 cl | 4 |
|----------|------|---|



Bol mini c/plato

| Referencia | Capacidad | Cantidad |
|------------|-----------|----------|
|------------|-----------|----------|

| | | |
|----------|------|---|
| 21108775 | 7 cl | 4 |
|----------|------|---|



Plato redondo

| Referencia | Medidas | Cantidad |
|------------|---------|----------|
| 21118027 | 29 cm Ø | 6 |



Plato oval

| Referencia | Medidas | Cantidad |
|------------|----------|----------|
| 21118025 | 32x26 cm | 6 |
| 21118026 | 30x24 cm | 6 |



Fuente oval

| Referencia | Medidas | Cantidad |
|------------|----------|----------|
| 21118334 | 47x24 cm | 1 |
| 21118059 | 40x20 cm | 1 |



Plato cuadrado

| Referencia | Medidas | Cantidad |
|------------|----------|----------|
| 21118028 | 29x29 cm | 6 |
| 21118029 | 24x24 cm | 6 |



Plato hondo

| Referencia | Medidas | Cantidad |
|------------|---------|----------|
| 21118030 | 29 cm Ø | 5 |



Plato pasta

| Referencia | Medidas | Cantidad |
|------------|---------|----------|
| 21118081 | 30 cm Ø | 1 |



Bol redondo

| Referencia | Medidas | Cantidad |
|------------|---------|----------|
| 21118031 | 22 cm Ø | 1 |
| 21118032 | 13 cm Ø | 6 |



Bol especial

| Referencia | Medidas | Cantidad |
|------------|----------|----------|
| 21118035 | 28x16 cm | 1 |
| 21118058 | 19x10 cm | 6 |



Bol oval

| Referencia | Medidas | Cantidad |
|------------|----------|----------|
| 21118033 | 27x21 cm | 4 |
| 21118034 | 18x14 cm | 6 |

Infinita



Plato grande

| Referencia | Medidas | Cantidad |
|------------|---------|----------|
|------------|---------|----------|

| | | |
|----------|---------|---|
| 21121478 | 28 cm Ø | 2 |
|----------|---------|---|



Plato pequeño

| Referencia | Medidas | Cantidad |
|------------|---------|----------|
|------------|---------|----------|

| | | |
|----------|---------|---|
| 21121479 | 22 cm Ø | 2 |
|----------|---------|---|



VISTA ALEGRE
1824

Mineral



Plato redondo Biscuit

Plato redondo Glaze

| Referencia | Medidas | Cantidad |
|------------|---------|----------|
|------------|---------|----------|

| | | |
|----------|---------|---|
| 21122762 | 23 cm Ø | 4 |
|----------|---------|---|

| Referencia | Medidas | Cantidad |
|------------|---------|----------|
|------------|---------|----------|

| | | |
|----------|---------|---|
| 21123216 | 23 cm Ø | 4 |
|----------|---------|---|



Plato rect Biscuit

Plato rect Glaze

| Referencia | Medidas | Cantidad |
|------------|---------|----------|
|------------|---------|----------|

| | | |
|----------|---------|---|
| 21122763 | 23 cm Ø | 4 |
|----------|---------|---|

| Referencia | Medidas | Cantidad |
|------------|---------|----------|
|------------|---------|----------|

| | | |
|----------|---------|---|
| 21123217 | 23 cm Ø | 4 |
|----------|---------|---|

Temptation



Plato centro pequeño

| Referencia | Medidas | Cantidad |
|------------|---------|----------|
|------------|---------|----------|

| | | |
|----------|---------|---|
| 21122367 | 29 cm Ø | 4 |
|----------|---------|---|



Plato centro grande

| Referencia | Medidas | Cantidad |
|------------|---------|----------|
|------------|---------|----------|

| | | |
|----------|---------|---|
| 21122366 | 29 cm Ø | 4 |
|----------|---------|---|



VISTA ALEGRE
1824

Tecido



Plato plano

| Referencia | Medidas | Cantidad |
|------------|---------|----------|
|------------|---------|----------|

| | | |
|----------|---------|---|
| 21117389 | 28 cm Ø | 2 |
|----------|---------|---|



Plato hondo

| Referencia | Medidas | Cantidad |
|------------|---------|----------|
|------------|---------|----------|

| | | |
|----------|---------|---|
| 21121416 | 28 cm Ø | 2 |
|----------|---------|---|

Terra Stoneware Azul



VISTA ALEGRE
 1824



Plato llano

| Referencia | Medidas | Cantidad |
|------------|---------|----------|
| 37002915 | 28 cm Ø | 6 |
| 37002926 | 23 cm Ø | 6 |
| 37003008 | 19 cm Ø | 6 |
| 37003007 | 16 cm Ø | 6 |



Plato hondo

| Referencia | Medidas | Cantidad |
|------------|---------|----------|
| 37003006 | 25 cm Ø | 6 |



Fuente redonda

| Referencia | Medidas | Cantidad |
|------------|---------|----------|
| 37002928 | 40 cm Ø | 1 |



Bol redondo

| Referencia | Medidas | Cantidad |
|------------|---------|----------|
| 37002927 | 16 cm Ø | 6 |



Fuente redonda

| Referencia | Medidas | Cantidad |
|------------|---------|----------|
| 37003009 | 18 cm Ø | 6 |



Vaso

| Referencia | Capacidad | Cantidad |
|------------|-----------|----------|
| 37003012 | 38 cl | 6 |



Taza café c/plato

| Referencia | Capacidad | Cantidad |
|------------|-----------|----------|
| 37003010 | 9 cl | 6 |



Taza té c/plato

| Referencia | Capacidad | Cantidad |
|------------|-----------|----------|
| 37003011 | 25 cl | 6 |

Terra Stoneware Zafiro



Plato llano

| Referencia | Medidas | Cantidad |
|------------|---------|----------|
| 37003031 | 28 cm Ø | 6 |
| 37003032 | 23 cm Ø | 6 |
| 37003037 | 19 cm Ø | 6 |
| 37003036 | 16 cm Ø | 6 |



Plato hondo

| Referencia | Medidas | Cantidad |
|------------|---------|----------|
| 37003035 | 25 cm Ø | 6 |



Fuente redonda

| Referencia | Medidas | Cantidad |
|------------|---------|----------|
| 37003034 | 40 cm Ø | 1 |



Bol redondo

| Referencia | Medidas | Cantidad |
|------------|---------|----------|
| 37003033 | 16 cm Ø | 6 |



Fuente redonda

| Referencia | Medidas | Cantidad |
|------------|---------|----------|
| 37003038 | 18 cm Ø | 6 |



Vaso

| Referencia | Capacidad | Cantidad |
|------------|-----------|----------|
| 37003041 | 38 cl | 6 |



Taza café c/plato

| Referencia | Capacidad | Cantidad |
|------------|-----------|----------|
| 37003039 | 9 cl | 6 |



Taza té c/plato

| Referencia | Capacidad | Cantidad |
|------------|-----------|----------|
| 37003040 | 25 cl | 6 |



Terra Stoneware Arena



Plato llano

| Referencia | Medidas | Cantidad |
|------------|---------|----------|
| 37002936 | 28 cm Ø | 6 |
| 37002937 | 23 cm Ø | 6 |
| 37003015 | 19 cm Ø | 6 |
| 37003014 | 16 cm Ø | 6 |



Plato hondo

| Referencia | Medidas | Cantidad |
|------------|---------|----------|
| 37003013 | 25 cm Ø | 6 |



Fuente redonda

| Referencia | Medidas | Cantidad |
|------------|---------|----------|
| 37002939 | 40 cm Ø | 1 |



Bol redondo

| Referencia | Medidas | Cantidad |
|------------|---------|----------|
| 37002938 | 16 cm Ø | 6 |



Fuente redonda

| Referencia | Medidas | Cantidad |
|------------|---------|----------|
| 37003016 | 18 cm Ø | 6 |



Vaso

| Referencia | Capacidad | Cantidad |
|------------|-----------|----------|
| 37003019 | 38 cl | 6 |



Taza café c/plato

| Referencia | Capacidad | Cantidad |
|------------|-----------|----------|
| 37003017 | 9 cl | 6 |



Taza té c/plato

| Referencia | Capacidad | Cantidad |
|------------|-----------|----------|
| 37003018 | 25 cl | 6 |

Utopía



Plato llano

| Referencia | Medidas | Cantidad |
|------------|---------|----------|
| 21127753 | 32 cm Ø | 4 |
| 21127754 | 29 cm Ø | 4 |
| 21127756 | 23 cm Ø | 4 |
| 21127757 | 17 cm Ø | |



Plato pasta

| Referencia | Medidas | Cantidad |
|------------|---------|----------|
| 21127758 | 28 cm Ø | 4 |



Plato hondo

| Referencia | Medidas | Cantidad |
|------------|---------|----------|
| 21127755 | 27 cm Ø | 4 |



Ensaladera bol

| Referencia | Medidas | Cantidad |
|------------|---------|----------|
| 21127760 | 22 cm Ø | 4 |
| 21127761 | 16 cm Ø | 4 |
| 21127762 | 11 cm Ø | 4 |



Taza/platillo

| Referencia | Capacidad | Cantidad |
|------------|-----------|----------|
| 21127763 | 42 cl | 4 |
| 21128452 | 24 cl | 4 |
| 21128450 | 11 cl | 4 |
| 21128453 | 17 cl | |
| 21128451 | 13 cl | |



Fuente oval

| Referencia | Medidas | Cantidad |
|------------|----------|----------|
| 21127759 | 35x28 cm | 4 |



Tetera

| Referencia | Capacidad | Cantidad |
|------------|-----------|----------|
| 21128448 | 1,32 Lt | 4 |
| 21128449 | 0,48 Lt | |



Lechera

| Referencia | Capacidad | Cantidad |
|------------|-----------|----------|
| 21127767 | 26 cl | 4 |



Sandía



Fuente redonda

| Referencia | Medidas | Cantidad |
|------------|---------|----------|
| 65020802 | 43 cm Ø | 1 |



Ensaladera

| Referencia | Medidas | Cantidad |
|------------|---------|----------|
| 65020807 | 35 cm Ø | 1 |
| 65020808 | 28 cm Ø | 1 |



Plato llano

| Referencia | Medidas | Cantidad |
|------------|-----------|----------|
| 65020803 | 32,5 cm Ø | 1 |
| 65030804 | 21 cm Ø | 1 |



Bol c/tapa

| Referencia | Medidas | Cantidad |
|------------|----------|----------|
| 65018693 | 26x22 cm | 1 |
| 65018687 | 21x19 cm | 1 |
| 65018681 | 13x12 cm | 1 |



Bol c/tapa

| Referencia | Medidas | Cantidad |
|------------|----------|----------|
| 65018690 | 26x22 cm | 1 |
| 65018684 | 21x19 cm | 1 |
| 65018678 | 13x12 cm | 1 |



Bol c/tapa

| Referencia | Medidas | Cantidad |
|------------|----------|----------|
| 65018648 | 26x22 cm | 1 |
| 65018645 | 21x19 cm | 1 |
| 65018642 | 13x12 cm | 1 |



Plato llano

| Referencia | Medidas | Cantidad |
|------------|-----------|----------|
| 65018597 | 32,5 cm Ø | 1 |
| 65003120 | 20 cm Ø | 1 |



Melón



Frutero

| Referencia | Capacidad | Cantidad |
|------------|-----------|----------|
| 65018596 | 3,7 Lt | 1 |



Bol/ensaladera

| Referencia | Medidas | Cantidad |
|------------|---------|----------|
| 65003300 | 25 cm Ø | 1 |
| 65003466 | 15 cm Ø | 1 |
| 65003467 | 13 cm Ø | 1 |



Terrina

| Referencia | Capacidad | Cantidad |
|------------|-----------|----------|
| 65018599 | 3,7 Lt | 1 |

Arborescence



Plato llano

| Referencia | Referencia | Referencia | Medidas | Cantidad |
|------------|------------|------------|---------|----------|
| 648324 | 648325 | 648326 | 31 cm | 2 |
| 648279 | 648280 | 648281 | 28 cm | 6 |
| 648342 | 648344 | 648345 | 26 cm | 6 |
| 648353 | 648474 | 648475 | 21,5 cm | 6 |
| 648362 | 648364 | 648365 | 16 cm | 6 |



REVOL

Plato hondo

| Referencia | Referencia | Referencia | Medidas | Cantidad |
|------------|------------|------------|---------|----------|
| 648288 | 648289 | 648290 | 24 cm | 6 |
| 648297 | 648298 | 648299 | 19 cm | 6 |
| 648390 | 648391 | 648392 | 15 cm | 6 |



Fuente recta

| Referencia | Referencia | Referencia | Medidas | Cantidad |
|------------|------------|------------|----------|----------|
| 648307 | 648308 | 648309 | 32x23 cm | 2 |
| 648334 | 648335 | 648336 | 30x15 cm | 6 |





Ensaladera

| Referencia | Referencia | Referencia | Medidas | Cantidad |
|------------|------------|------------|---------|----------|
| 650476 | 650477 | 650478 | 27,3 cm | 1 |
| | | | | |

Cuenco

| Referencia | Referencia | Referencia | Medidas | Cantidad |
|------------|------------|------------|---------|----------|
| 648941 | 648942 | 648943 | 14 cm | 6 |
| 650001 | 650002 | 650003 | 16 cm | 6 |
| 648398 | 648399 | 648400 | 7 cm | 6 |
| | | | | |



Taza - Mug

| Referencia | Referencia | Referencia | Capacidad | Cantidad |
|------------|------------|------------|-----------|----------|
| 648406 | 648407 | 648408 | 8 cl | 6 |
| 648843 | 648844 | 648845 | 18 cl | 6 |
| 648431 | 648432 | 648433 | 25 cl | 6 |
| | | | | |



Bol arroz



| Referencia | Referencia | Referencia | Medidas | Cantidad |
|------------|------------|------------|---------|----------|
| 648926 | 648927 | 648928 | 12 cm | 6 |
| | | | | |

Equinaxe

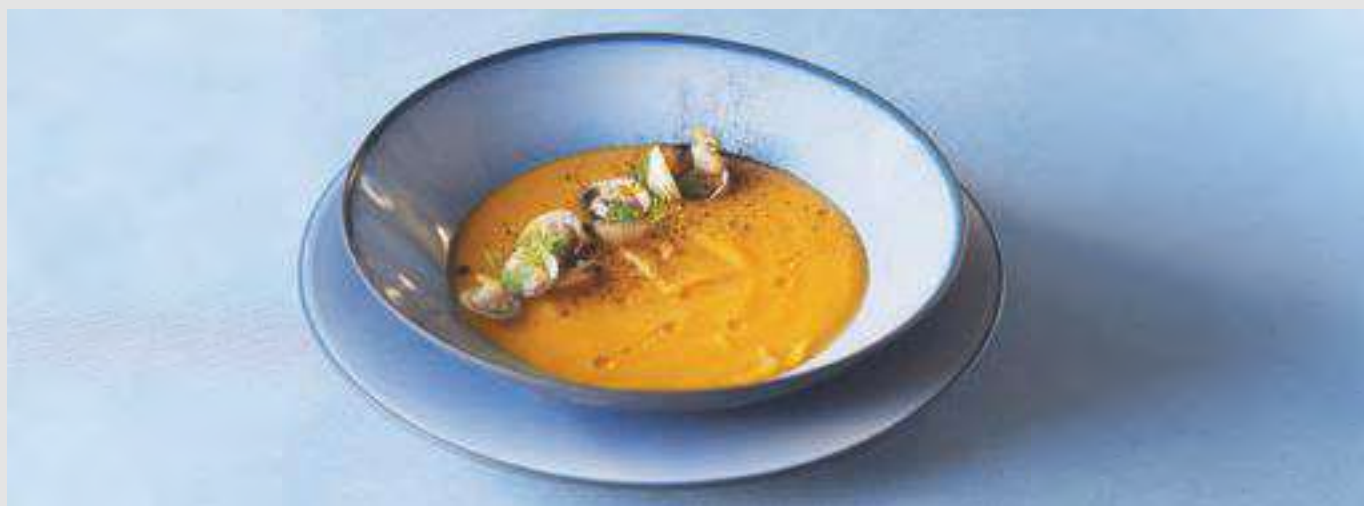

Plato llano



| Referencia | Referencia | Referencia | Medidas | Cantidad |
|------------|------------|------------|---------|----------|
| 649503 | 649502 | 649501 | 31 cm | 2 |
| 649500 | 649499 | 649497 | 28 cm | 6 |
| 650423 | 650420 | 650421 | 26 cm | 6 |
| 650432 | 650430 | 650431 | 24 cm | 6 |
| 649496 | 849495 | 649494 | 21,5 cm | 6 |
| 649493 | 649492 | 649491 | 16 cm | 6 |



Plato hondo



| Referencia | Referencia | Referencia | Medidas | Cantidad |
|------------|------------|------------|---------|----------|
| 649559 | 649557 | 649558 | 27 cm | 4 |
| 649506 | 649505 | 649504 | 24 cm | 6 |
| 649579 | 649578 | 649577 | 19 cm | 6 |
| 649589 | 649588 | 649587 | 15 cm | 6 |



Bol arroz

| Referencia | Referencia | Referencia | Medidas | Cantidad |
|------------|------------|------------|---------|----------|
|------------|------------|------------|---------|----------|

| | | | | |
|--------|--------|--------|-------|---|
| 649596 | 649595 | 649594 | 12 cm | 6 |
|--------|--------|--------|-------|---|



Bol plano

| Referencia | Referencia | Referencia | Medidas | Cantidad |
|------------|------------|------------|---------|----------|
|------------|------------|------------|---------|----------|

| | | | | |
|--------|--------|--------|-------|---|
| 649509 | 649508 | 649507 | 14 cm | 6 |
|--------|--------|--------|-------|---|



Bol cónico

| Referencia | Referencia | Referencia | Capacidad | Cantidad |
|------------|------------|------------|-----------|----------|
|------------|------------|------------|-----------|----------|

| | | | | |
|--------|--------|--------|-------|---|
| 649611 | 649609 | 649610 | 25 cl | 4 |
|--------|--------|--------|-------|---|



| | | | | |
|--------|--------|--------|------|---|
| 649607 | 649605 | 649606 | 5 cl | 6 |
|--------|--------|--------|------|---|



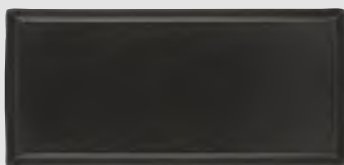
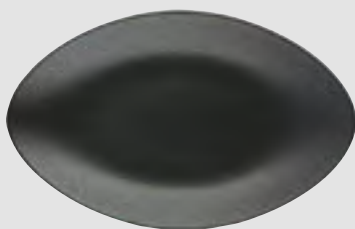
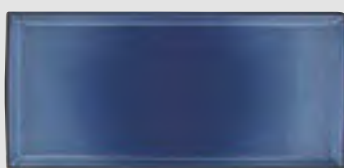

REVOL





Dim Sum

| Referencia | Referencia | Referencia | Medidas | Cantidad |
|---|---|---|---------|----------|
| 649524 | 649522 | 649523 | 22 cm | 1 |
|  |  |  | | |

Fuente oval

| Referencia | Referencia | Referencia | Medidas | Cantidad |
|---|---|---|---------|----------|
| 649556 | 649554 | 649555 | 35 cm | 4 |
|  |  |  | | |

Fuente recta

| Referencia | Referencia | Referencia | Medidas | Cantidad |
|---|---|---|---------|----------|
| 649568 | 649566 | 649567 | 32,5 cm | 4 |
|  |  |  | | |

-  Cirrus Bleu
-  Noir
-  Poivre



Solid



Plato esfera

| Referencia | Medidas | Cantidad |
|------------|---------|----------|
| 645673 | 30 cm | 4 |



650354



650355



650356



Baguette

| Referencia | Medidas | Cantidad |
|------------|----------|----------|
| 645765 | 8,5x5 cm | 6 |
| 645768 | 15x5 cm | 6 |
| 645866 | 27x5 cm | 6 |



Plato hondo



| Referencia | Referencia | Referencia | Medidas | Cantidad |
|------------|------------|------------|---------|----------|
| 649099 | 649100 | 649101 | 23,5 cm | 4 |
| 647495 | 647496 | 647497 | 17,5 cm | 4 |



| Referencia | Referencia | Referencia | Medidas | Cantidad |
|-------------------|------------|------------|-----------------|----------|
| Ensaladera 649096 | 649097 | 649098 | 20 cm - 1,5 lt | 3 |
| Bol 646369 | 646370 | 646371 | 13 cm - 0,55 lt | 6 |
| Bol 646398 | 646399 | 646400 | 11 cm - 0,30 lt | 6 |
| Bol mini 647322 | 647323 | 647324 | 5 cm - 0,03 lt | 6 |



Plato tapas



| Referencia | Referencia | Referencia | Medidas | Cantidad |
|------------|------------|------------|---------|----------|
| 646231 | 646232 | 646233 | 16 cm | 6 |



Tubo

| Referencia | Referencia | Referencia | Capacidad | Cantidad |
|------------|------------|------------|-----------|----------|
| 646428 | 646429 | 646430 | 5 cl | 6 |



REVOL

Bol tapas

| Referencia | Referencia | Referencia | Capacidad | Cantidad |
|------------|------------|------------|-----------|----------|
| 646421 | 646422 | 646423 | 15 cl | 6 |





Jarra

| Referencia | Referencia | Referencia | Capacidad | Cantidad |
|------------|------------|------------|-----------|----------|
|------------|------------|------------|-----------|----------|

| | | | | |
|--------|--------|--------|---------|---|
| 644309 | 644375 | 644385 | 0,10 lt | 4 |
| 644306 | 644378 | 644386 | 0,25 lt | 4 |
| 644303 | 644346 | 644387 | 0,50 lt | 4 |
| 644837 | 644833 | 644836 | 0,75 lt | 4 |



Salsera

| Referencia | Referencia | Referencia | Capacidad | Cantidad |
|------------|------------|------------|-----------|----------|
|------------|------------|------------|-----------|----------|

| | | | | |
|--------|--------|--------|-------|---|
| 644988 | 644989 | 644990 | 20 cl | 4 |
|--------|--------|--------|-------|---|



Sopera

| Referencia | Referencia | Referencia | Capacidad | Cantidad |
|------------|------------|------------|-----------|----------|
|------------|------------|------------|-----------|----------|

| | | | | |
|--------|--------|--------|-------|---|
| 646403 | 646407 | 646408 | 45 cl | 6 |
|--------|--------|--------|-------|---|



Saturno



Cúpula plato hondo

| Referencia | Cantidad |
|------------|----------|
|------------|----------|

| | |
|-------------|---|
| 04514320001 | 4 |
| 04514300001 | 4 |



Plato llano

| Referencia | Medidas | Cantidad |
|------------|---------|----------|
|------------|---------|----------|

| | | |
|-------------|---------|----|
| 04500030001 | 33 cm Ø | 6 |
| 04600100001 | 29 cm Ø | 12 |
| 04500200001 | 24 cm Ø | 12 |
| 04500400001 | 17 cm Ø | 12 |



Plato hondo gourmet

| Referencia | Medidas | Cantidad |
|------------|---------|----------|
|------------|---------|----------|

| | | |
|-------------|---------|----|
| 04500060001 | 29 cm Ø | 12 |
| 04514290001 | 25 cm Ø | 12 |



Plato hondo

| Referencia | Medidas | Cantidad |
|------------|---------|----------|
|------------|---------|----------|

| | | |
|-------------|---------|----|
| 04600250001 | 25 cm Ø | 12 |
|-------------|---------|----|



Ensaladera oval

| Referencia | Medidas | Cantidad |
|------------|---------|----------|
|------------|---------|----------|

| | | |
|-------------|----------|----|
| 04500780001 | 33x18 cm | 1 |
| 04500800001 | 25x13 cm | 2 |
| 04500900001 | 17x9 cm | 8 |
| 04510150001 | 10x7 cm | 12 |



Bol

| Referencia | Medidas | Cantidad |
|------------|---------|----------|
|------------|---------|----------|

| | | |
|-------------|---------|----|
| 04503690001 | 14 cm Ø | 12 |
| 04510160001 | 10 cm Ø | 12 |



Tacerío

| Referencia | Capacidad | Cantidad |
|------------|-----------|----------|
|------------|-----------|----------|

| | | |
|-------------|--------|----|
| 04501810001 | 34 cl | 12 |
| 04501910001 | 26 cl | 12 |
| 04502100001 | 20 cl | 12 |
| 04501990001 | 10 cl | 12 |
| 04502010001 | 7,5 cl | 12 |

Fuente oval

| Referencia | Medidas | Cantidad |
|------------|---------|----------|
|------------|---------|----------|

| | | |
|------------|----------|---|
| 0450037001 | 57x24 cm | 1 |
| 0450038001 | 48x21 cm | 1 |
| 0450039001 | 38x20 cm | 1 |



| | | |
|-------------|---------|----|
| 04501820001 | 18 cm Ø | 12 |
| 04502110001 | 16 cm Ø | 12 |
| 04502020001 | 12 cm Ø | 12 |

costaverde



Boheme

Aria



Plato llano

| Referencia | Medidas | Cantidad |
|-------------|----------|----------|
| 04100150001 | 30x26 cm | 12 |
| 04100300001 | 23x20 cm | 12 |



Plato hondo

| Referencia | Medidas | Cantidad |
|------------|----------|----------|
| 0450037001 | 20x18 cm | 12 |



Plato llano

| Referencia | Medidas | Cantidad |
|-------------|----------|----------|
| 04200150001 | 30x26 cm | 12 |
| 04200300001 | 23x20 cm | 12 |
| 04200250001 | 20x18 cm | 12 |



Plato hondo

| Referencia | Medidas | Cantidad |
|-------------|----------|----------|
| 04200060001 | 30x26 cm | 12 |

Opera



Plato llano

| Referencia | Medidas | Cantidad |
|-------------|----------|----------|
| 04000030001 | 36x30 cm | 6 |
| 04000150001 | 31x26 cm | 12 |
| 04000300001 | 25x21 cm | 12 |
| 04000350001 | 21x18 cm | 12 |



Plato hondo

| Referencia | Medidas | Cantidad |
|------------|----------|----------|
| 0400025001 | 21x18 cm | 12 |



Fuente

| Referencia | Medidas | Cantidad |
|-------------|----------|----------|
| 04000450001 | 43x30 cm | 1 |
| 04000500001 | 37x26 cm | 1 |
| 04000550001 | 33x24 cm | 1 |

Fuente larga

| Referencia | Medidas | Cantidad |
|-------------|----------|----------|
| 04000370001 | 57x23 cm | 1 |
| 04000380001 | 47x19 cm | 1 |
| 04000490001 | 38x14 cm | 1 |



costaverde

Concrete



Plato rectangular

| Referencia | Medidas | Cantidad |
|------------|------------|----------|
| 9129688 | 27,5x13 cm | 4 |



Plato cuadrado

| Referencia | Medidas | Cantidad |
|------------|----------|----------|
| 9129690 | 28x28 cm | 2 |



Plato redondo

| Referencia | Medidas | Cantidad |
|------------|-----------|----------|
| 9129689 | 28,5 cm Ø | 4 |



Holi Carbone



Plato llano negro

| Referencia | Medidas | Cantidad |
|------------|-----------|----------|
| 9129681 | 28,5 cm Ø | 6 |
| 9129687 | 16 cm Ø | 6 |



Plato llano negro

| Referencia | Medidas | Cantidad |
|------------|-----------|----------|
| 9129682 | 25,5 cm Ø | 6 |
| 9129684 | 21,5 cm Ø | 6 |



Plato llano rojo

| Referencia | Medidas | Cantidad |
|------------|-----------|----------|
| 9129675 | 28,5 cm Ø | 6 |
| 9129679 | 16 cm Ø | 6 |



Plato llano rojo

| Referencia | Medidas | Cantidad |
|------------|-----------|----------|
| 9129677 | 25,5 cm Ø | 6 |
| 9129678 | 21,5 cm Ø | 6 |



Plato gourmet

| Referencia | Medidas | Cantidad |
|------------|---------|----------|
| 7534248 | 28 cm Ø | 6 |



Plato cuadrado

| Referencia | Medidas | Cantidad |
|------------|----------|----------|
| 7534246 | 27x27 cm | 12 |



Plato cuadrado

| Referencia | Medidas | Cantidad |
|------------|----------|----------|
| 7534245 | 20x20 cm | 12 |



Plato hondo

| Referencia | Medidas | Cantidad |
|------------|---------|----------|
| 7534247 | 26 cm Ø | 6 |



Plato triangular

| Referencia | Medidas | Cantidad |
|------------|----------|----------|
| 7534250 | 29x19 cm | 6 |



Plato triangular

| Referencia | Medidas | Cantidad |
|------------|----------|----------|
| 7534249 | 21x14 cm | 12 |



Bol triangular

| Referencia | Medidas | Cantidad |
|------------|----------|----------|
| 7534252 | 14x10 cm | 12 |



Bol triangular

| Referencia | Medidas | Cantidad |
|------------|---------|----------|
| 7534251 | 12x8 cm | 12 |



Plato llano blanco

| Referencia | Medidas | Cantidad |
|------------|-----------|----------|
| A02/0101 | 27,5 cm Ø | 24 |
| A02/0102 | 21 cm Ø | 36 |
| A02/0103 | 17 cm Ø | 36 |



Plato hondo blanco

| Referencia | Medidas | Cantidad |
|------------|---------|----------|
| A0148 | 27 cm Ø | 12 |
| A02/0104 | 23 cm Ø | 36 |
| A0150 | 20 cm Ø | 48 |



Plato pasta

| Referencia | Medidas | Cantidad |
|------------|-----------|----------|
| A0149 | 30,5 cm Ø | 12 |



Plato presentación

| Referencia | Medidas | Cantidad |
|------------|---------|----------|
| A02/0105 | 31 cm Ø | 6 |

CRISTALERÍA

Glassware • Verrerie • Vetreria • Glaswaren





100 00 37



100 00 35



100 00 01



100 00 02



100 00 07

| Código | Descripción | Capacidad | Altura |
|-----------|----------------|-----------|----------|
| 100 00 37 | Copa Burdeos | 660 ml | 223,5 mm |
| 100 00 35 | Copa Burdeos | 540 ml | 212,0 mm |
| 100 00 01 | Copa Tinto | 450 ml | 205,0 mm |
| 100 00 02 | Copa Blanco | 350 ml | 195,5 mm |
| 100 00 07 | Copa Champagne | 200 ml | 212,0 mm |





Las proporciones bien equilibradas y elegantes de la copa Exquisit se combinan para crear una copa atractiva y funcional. En comparación con otros diseños, la Exquisit destaca por la forma independiente de su cáliz y la curvatura suave con la que continúa el tallo, para finalizar en una base sólida y resistente, que hacen que esta copa tenga el equilibrio perfecto.

Su diseño estético y su alta durabilidad hacen de la Exquisit la copa perfecta para la restauración y la hostelería, con una relación calidad/precio inmejorable.

| Código | Descripción | Capacidad | Altura |
|---------|----------------|-----------|--------|
| 1470035 | Copa Burdeos | 645 ml | 230 mm |
| 1470001 | Copa Tinto | 480 ml | 215 mm |
| 1470003 | Copa Blanco | 420 ml | 211 mm |
| 1470002 | Copa Blanco | 350 ml | 203 mm |
| 1470029 | Copa Champagne | 265 ml | 223 mm |
| 1470007 | Copa Cava | 175 ml | 221 mm |
| 1477402 | Copa Negra | 350 ml | 203 mm |
| 3520012 | Vaso | 465 ml | 120 mm |



3520012



Revolution



3770000



3770001



3770002



3770007

| Código | Descripción | Capacidad | Altura |
|---------|--------------|-----------|--------|
| 3770000 | Copa Burdeos | 545 ml | 220 mm |
| 3770001 | Copa Tinto | 490 ml | 225 mm |
| 3770002 | Copa Blanco | 365 ml | 220 mm |
| 3770007 | Copa Cava | 200 ml | 225 mm |





2200000



2200035



2200001



2200002



2200003



2200007

| Código | Descripción | Capacidad | Altura |
|---------|----------------|-----------|--------|
| 2200000 | Copa Burdeos | 695 ml | 231 mm |
| 2200035 | Copa Burdeos | 645 ml | 238 mm |
| 2200001 | Copa Tinto | 450 ml | 225 mm |
| 2200002 | Copa Blanco | 350 ml | 214 mm |
| 2200003 | Copa Blanco | 285 ml | 208 mm |
| 2200007 | Copa Champagne | 188 ml | 224 mm |



Probablemente, el mejor cristal del mundo.



*Más duro y brillante.
Más resistente a las roturas.
Mas resistente al lavavajillas.*

Un salto revolucionario en la fabricación de cristal.

Tras una larga e intensa investigación. Schott Zwiesel ha desarrollado un nuevo cristal libre de plomo. En su composición entran óxidos de zinc, titanio y circonio.

Combinado con un nuevo proceso de fabricación, surge un cristal de cualidades extraordinarias en cuanto a dureza, brillo y sonoridad, muy resistente a la rotura y a la acción corrosiva del lavavajillas.

Un cristal muy duro, sonoro y brillante.

El nuevo cristal **Tritan®** posee grados de sonoridad, dureza y brillantez superiores. Las pruebas de laboratorio avalan que después de 1.000 vueltas en arena de cuarzo, la superficie de las copas fabricadas con Tritan® no presenta signos de rayaduras. La exposición continuada a la luz intensa tampoco merma el brillo radiante de las copas.





N-0



N-2



N-77



N-130



N-140

| Código | Descripción | Capacidad | Altura |
|--------|----------------|-----------|--------|
| 119958 | Chardonnay N-0 | 37,2 cl | 199 mm |
| 119959 | Riestling N-2 | 31,3 cl | 191 mm |
| 119962 | Champán N-77 | 24,5 cl | 204 mm |
| 119960 | Burdeos N-130 | 50,5 cl | 214 mm |
| 119961 | Borgoña N-140 | 61,6 cl | 199 mm |



Compacta, sofisticada y excepcionalmente funcional. Éste el concepto de la copa Fiesta y su versátil colección se adapta a todos los ambientes. Desarrollada para uso profesional y con unos requerimientos de forma, calidad y funcionalidad.





N-140



N-130



N-1



N-0



N-7

| Código | Descripción | Capacidad | Altura |
|--------|---------------|-----------|--------|
| 115589 | Borgoña N-140 | 78,3 cl | 221 mm |
| 115588 | Burdeos N-130 | 63,3 cl | 230 mm |
| 115587 | Tintos N-1 | 50,6 cl | 224 mm |
| 115586 | Blancos N-0 | 34,9 cl | 208 mm |
| 115590 | Cava N-7 | 22,8 cl | 222 mm |





| Código | Descripción | Capacidad | Altura |
|--------|----------------|-----------|--------|
| 118609 | Vino N-1 | 43,7 cl | 244 mm |
| 118602 | Chardonnay N-0 | 38,5 cl | 229 mm |
| 118604 | Riesling N-2 | 31,6 cl | 222 mm |
| 118607 | Champán N-77 | 29,8 cl | 238 mm |
| 118605 | Agua N-32 | 38,5 cl | 181 mm |
| 118608 | Burdeos N-130 | 63,0 cl | 261 mm |
| 118609 | Borgoña N-140 | 66,0 cl | 233 mm |





N-1

N-0

N-2

N-3

N-7

N-140

| Código | Descripción | Capacidad | Altura |
|--------|--------------------|-----------|--------|
| 174487 | Copa Vino N-1 | 41,5 cl | 205 mm |
| 133903 | Copa Vino N-0 | 32,0 cl | 197 mm |
| 133920 | Copa Vino N-2 | 25,0 cl | 187 mm |
| 167703 | Copa Vino N-3 | 20,0 cl | 180 mm |
| 133934 | Copa Cava N-7 | 19,0 cl | 210 mm |
| 172927 | Copa Borgoña N-140 | 58,5 cl | 195 mm |



Taste



N-1

N-0

N-7

N-130

N-140

| Código | Descripción | Capacidad | Altura |
|--------|--------------------|-----------|--------|
| 115671 | Copa Vino N-1 | 49,7 cl | 225 mm |
| 115670 | Copa Vino N-0 | 35,6 cl | 211 mm |
| 115674 | Copa Cava N-7 | 28,3 cl | 231 mm |
| 115672 | Copa Burdeos N-130 | 65,6 cl | 237 mm |
| 115673 | Copa Borgoña N-140 | 78,2 cl | 227 mm |





N-1



N-0



N-2



N-7



N-130



N-140



| Código | Descripción | Capacidad | Altura |
|--------|--------------------|-----------|--------|
| 112413 | Copa Vino N-1 | 54,0 cl | 244 mm |
| 112412 | Copa Vino N-0 | 40,8 cl | 232 mm |
| 112414 | Copa Vino N-2 | 30,0 cl | 220 mm |
| 112415 | Copa Cava N-7 | 20,9 cl | 252 mm |
| 112420 | Copa Burdeos N-130 | 68,0 cl | 267 mm |
| 112421 | Copa Borgoña N-140 | 69,2 cl | 234 mm |

Classico



N-1



N-0



N-2



N-7



N-130



N-140



| Código | Descripción | Capacidad | Altura |
|--------|--------------------|-----------|--------|
| 106220 | Copa Vino N-1 | 54,5 cl | 240 mm |
| 106219 | Copa Vino N-0 | 40,8 cl | 225 mm |
| 106221 | Copa Vino N-2 | 31,2 cl | 210 mm |
| 106223 | Copa Cava N-7 | 21,0 cl | 242 mm |
| 106226 | Copa Burdeos N-130 | 64,5 cl | 250 mm |
| 106227 | Copa Borgoña N-140 | 81,4 cl | 230 mm |

ARCOROC

Los profesionales de la sumillería buscan copas que respondan a sus exigencias de perfección y refinamiento.

Su deseo: una mesa en su restaurante compuesta por artículos finos, ligeros y extremadamente transparentes.

Su exigencia profesional: Un uso intensivo diario que reclama productos con una gran resistencia a los golpes y a los detergentes. Para responder a ese doble desafío de excelencia estética y de resistencia, el centro de investigación Arc, presenta una nueva generación de cristalino sin plomo: KRYSTA, el cristalino con un rendimiento excepcional.



Mayor finura y resistencia



Mayor transparencia y brillo



Sonido claro y puro



Brillo extremo y duradero





ARCOROC

Reveal Up

CRISTALERÍA



9219014



9218909



9218742



9218743



9218908



9218907

| Código | Descripción | Capacidad | Altura |
|---------|--------------|-----------|--------|
| 9219014 | Copa Vino | 55 cl | 236 mm |
| 9218909 | Copa Vino | 50 cl | 247 mm |
| 9218742 | Copa Vino | 45 cl | 222 mm |
| 9218743 | Copa Vino | 40 cl | 232 mm |
| 9218908 | Copa Vino | 30 cl | 217 mm |
| 9218907 | Copa Flauta | 21 cl | 234 mm |
| 9219522 | Vaso Soft | 40 cl | 93 mm |
| 9219524 | Vaso Intense | 40 cl | 86 mm |



9219522



9219524

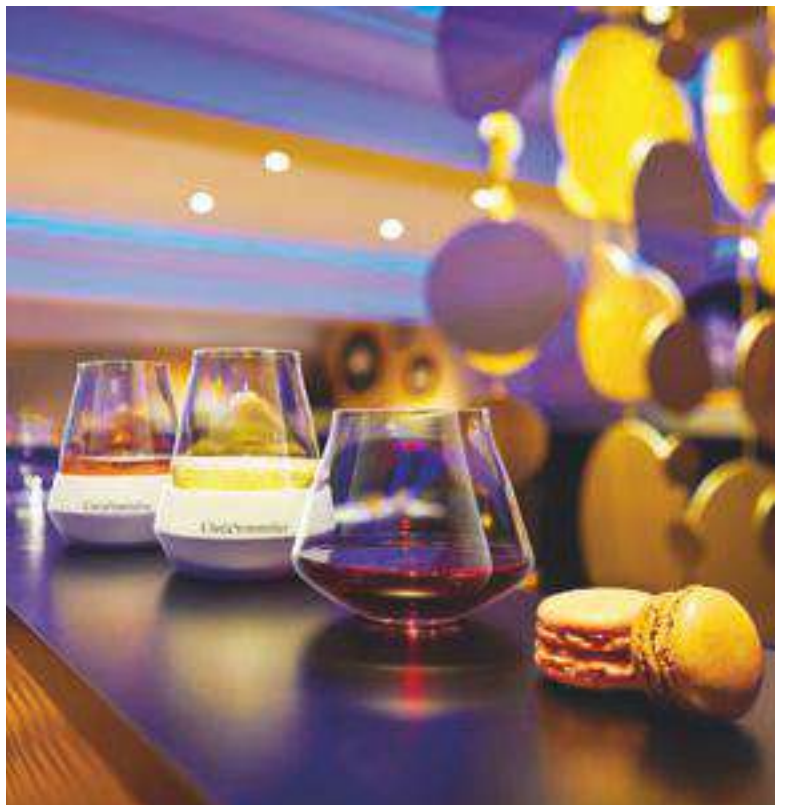

Cabernet

ARCOROC



CRISTALERÍA



1121198



1121197



1121196



1121195



1121194



8853468

| Código | Descripción | Capacidad | Altura |
|---------|-------------|-----------|--------|
| 1121198 | Tulipe | 75 cl | 240 mm |
| 1121197 | Tulipe | 58 cl | 230 mm |
| 1121196 | Tulipe | 47 cl | 220 mm |
| 1121195 | Tulipe | 35 cl | 202 mm |
| 1121194 | Tulipe | 25 cl | 180 mm |
| 8853468 | Tulipe | 19 cl | 165 mm |
| 9222789 | Copa Vino | 58 cl | 220 mm |
| 9222790 | Copa Vino | 47 cl | 210 mm |
| 9222788 | Copa Vino | 35 cl | 200 mm |



9222789



9222790



9222788





ARCOROC

Open up

CRISTALERÍA



| Código | Descripción | Capacidad | Altura |
|---------|-------------------|-----------|--------|
| 9261013 | Tannic | 55 cl | 232 mm |
| 9261012 | Soft | 47 cl | 228 mm |
| 9261011 | Universal Tasting | 40 cl | 231 mm |
| 9261010 | Round | 37 cl | 210 mm |
| 9261009 | Sweet | 27 cl | 190 mm |
| 9261008 | Pro Tasting | 32 cl | 180 mm |
| 9261051 | Effervescent | 20 cl | 233 mm |
| 9261041 | Vaso Alto | 35 cl | 120 mm |
| 9261033 | Vaso Bajo | 38 cl | 92 mm |



Grandes Cepages



CRISTALERÍA

ARCOROC



9226245



9226101



9290935



9219088



9226250



9219198

| Código | Descripción | Capacidad | Altura |
|---------|-------------|-----------|--------|
| 9226245 | Copa Tinto | 62 cl | 238 mm |
| 9226101 | Copa Tinto | 47 cl | 227 mm |
| 9290935 | Copa Tinto | 35 cl | 210 mm |
| 9219088 | Copa Tinto | 25 cl | 185 mm |
| 9226250 | Copa Flauta | 24 cl | 235 mm |
| 9219198 | Copa Flauta | 19 cl | 204 mm |





ARCOROC

Sensation

CRISTALERÍA



9227695



9227696



9227697



9227698



9227700

| Código | Descripción | Capacidad | Altura |
|---------|------------------|-----------|--------|
| 9227695 | Copa Agua grande | 41 cl | 205 mm |
| 9227696 | Copa Agua | 31 cl | 195 mm |
| 9227697 | Copa Tinto | 25 cl | 185 mm |
| 9227698 | Copa Blanco | 20 cl | 180 mm |
| 9227700 | Copa Cava | 19 cl | 210 mm |



Viña



N-1



N-0



N-2



N-7



N-130



N-140

| Código | Descripción | Capacidad | Altura |
|--------|--------------------|-----------|--------|
| 110459 | Copa Vino N-1 | 58 cl | 227 mm |
| 110458 | Copa Vino N-0 | 45 cl | 217 mm |
| 110485 | Copa Vino N-2 | 35 cl | 203 mm |
| 110488 | Copa Cava N-7 | 27 cl | 225 mm |
| 110496 | Copa Burdeos N-130 | 16 cl | 225 mm |
| 110499 | Copa Borgoña N-140 | 16 cl | 221 mm |





| Código | Descripción | Capacidad | Altura |
|---------|------------------|-----------|--------|
| 9202091 | Copa Vino | 58 cl | 255 mm |
| 9202006 | Copa Vino | 45 cl | 234 mm |
| 9202007 | Copa Vino | 35 cl | 219 mm |
| 9202010 | Copa Vino | 27 cl | 202 mm |
| 9202090 | Copa Cava Flauta | 16 cl | 224 mm |



Sequence



Finura de la boca (1,2 mm),
confort al contacto con los labios

El perfil sigue unas perfectas
líneas continuas

Base ancha, mejor respiración
del vino

Pie delicado con unión lisa

Base del pié plana que favorece la
estabilidad y evita la retención del
agua en el lavavajillas



| Código | Descripción | Capacidad | Altura |
|---------|-------------|-----------|--------|
| 9129951 | Copa Vino | 74 cl | 235 mm |
| 9129950 | Copa Vino | 53 cl | 235 mm |
| 9129949 | Copa Vino | 44 cl | 227 mm |
| 9129948 | Copa Vino | 35 cl | 210 mm |
| 9129947 | Copa Vino | 17 cl | 208 mm |

El modelo Spirit de Hoterali@ combina robustez y elegancia con la mejor relación calidad/precio.



| Código | Descripción | Capacidad | Altura |
|-----------|------------------|-----------|--------|
| 3642SCL58 | Copa Vino | 58 cl | 213 mm |
| 3656SCL46 | Copa Vino | 46 cl | 207 mm |
| 3565SCL35 | Copa Vino | 35 cl | 196 mm |
| 3565SCL24 | Copa Vino | 25 cl | 180 mm |
| 3656SCL20 | Copa Cava Flauta | 20 cl | 198 mm |



Lira



Agua

Vino

Flauta

| Código | Descripción | Capacidad | Altura |
|----------|-------------|-----------|--------|
| 10511650 | Copa Agua | 23 cl | 156 mm |
| 10511651 | Copa Vino | 16 cl | 140 mm |
| 10511653 | Copa Flauta | 15 cl | 169 mm |

Normandie

ARCOROC



Agua

Vino

Jerez

Cava

| Código | Descripción | Capacidad | Altura |
|---------|-------------|-----------|--------|
| 1031120 | Copa Agua | 23 cl | 174 mm |
| 1031121 | Copa Vino | 16 cl | 145 mm |
| 1031122 | Copa Jerez | 11 cl | 127 mm |
| 1231123 | Copa Cava | 15 cl | 174 mm |

Lineal



Gran vino

Agua

Vino

Jerez

Cava

| Código | Descripción | Capacidad | Altura |
|---------|-------------|-----------|--------|
| 9239515 | Gran vino | 45 cl | 215 mm |
| 9233570 | Agua | 31 cl | 197 mm |
| 9233572 | Vino | 25 cl | 174 mm |
| 9233571 | Jerez | 19 cl | 165 mm |
| 9233569 | Cava | 18 cl | 196 mm |



Vesubio



| Código | Descripción | Capacidad | Altura |
|---------|-------------|-----------|--------|
| 9214613 | Copa Mesa | 23 cl | 122 mm |
| 9215354 | Copa Mesa | 14 cl | 109 mm |
| 9214612 | Copa Zumó | 20 cl | 155 mm |
| 9216021 | Copa Flauta | 15 cl | 150 mm |

Suecia

ARCOROC



| Código | Descripción | Capacidad | Altura |
|---------|-------------|-----------|--------|
| 1051610 | Copa Agua | 25 cl | 134 mm |
| 1051611 | Copa Vino | 20 cl | 124 mm |

CRISTALERÍA

Princesa



| Código | Descripción | Capacidad | Altura |
|---------|--------------|-----------|--------|
| 1051719 | Gran vino | 42 cl | 212 mm |
| 1051720 | Agua | 31 cl | 197 mm |
| 1051721 | Agua pequeña | 23 cl | 174 mm |
| 1051723 | Vino | 19 cl | 165 mm |
| 1051722 | Vino pequeña | 14 cl | 153 mm |
| 1051724 | Jerez | 9 cl | 139 mm |
| 1051726 | Cava | 15 cl | 196 mm |





XL



Large



Medium



Small



Flute

| Código | Descripción | Capacidad | Altura |
|--------|-------------|-----------|--------|
| 365700 | Copa XL | 64 cl | 243 mm |
| 365710 | Copa Large | 56 cl | 233 mm |
| 365720 | Copa Medium | 47 cl | 220 mm |
| 365730 | Copa Small | 38 cl | 207 mm |
| 365740 | Copa Flute | 28 cl | 243 mm |





XL

Large

Medium

Small

XS

Flute

| Código | Descripción | Capacidad | Altura |
|--------|-------------|-----------|--------|
| 365780 | Copa XL | 65,5 cl | 243 mm |
| 365781 | Copa Large | 57 cl | 235 mm |
| 365782 | Copa Medium | 46,5 cl | 220 mm |
| 365783 | Copa Small | 38,5 cl | 210 mm |
| 365784 | Copa XS | 22,5 cl | 185 mm |
| 365785 | Copa Flute | 32 cl | 239 mm |



Riserva



Burdeos



Borgoña



Nebbiolo



Cabernet



Barolo



Cava

| Código | Descripción | Capacidad | Altura |
|--------|-------------|-----------|--------|
| 166150 | Burdeos | 53 cl | 233 mm |
| 166820 | Borgoña | 40 cl | 212 mm |
| 166860 | Nebbiolo | 50 cl | 224 mm |
| 166870 | Cabernet | 39 cl | 212 mm |
| 166170 | Barolo | 46 cl | 195 mm |
| 166220 | Cava | 21 cl | 220 mm |



New Kalix



Burgundy



Goblet



Agua



Vino



Cava

| Código | Descripción | Capacidad | Altura |
|--------|---------------|-----------|--------|
| 136100 | Copa Burgundy | 43 cl | 200 mm |
| 136140 | Copa Goblet | 35 cl | 188 mm |
| 136130 | Copa Agua | 27 cl | 180 mm |
| 136110 | Copa Vino | 22 cl | 169 mm |
| 136120 | Copa Cava | 17 cl | 196 mm |



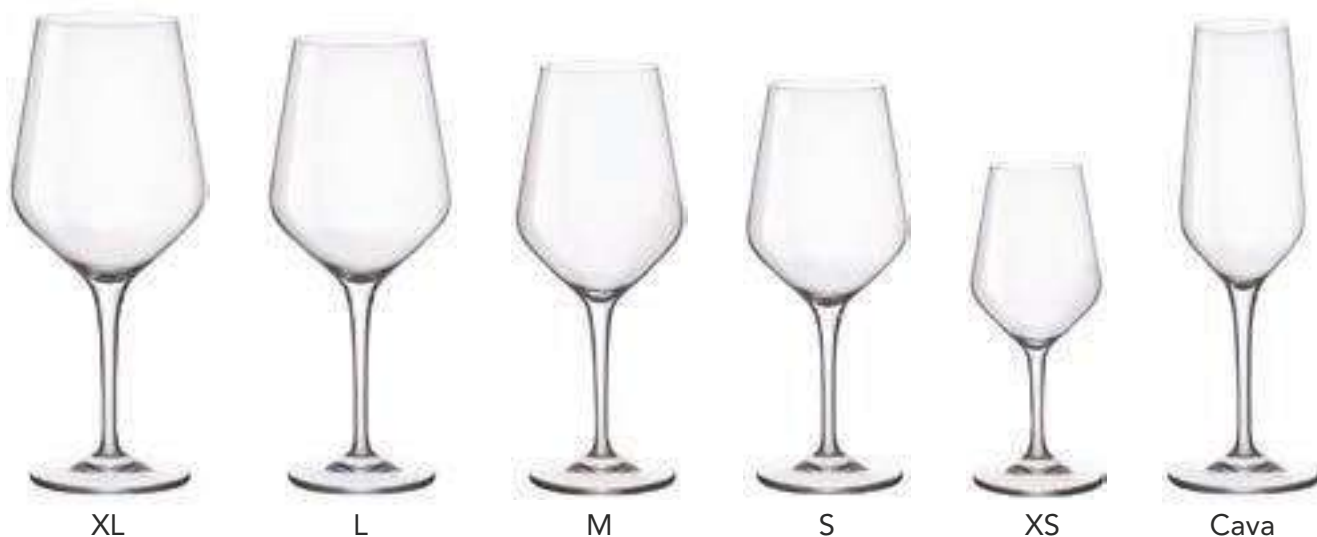

| Código | Descripción | Capacidad | Altura |
|--------|--------------|-----------|--------|
| 192342 | Copa Vino XL | 65 cl | 240 mm |
| 192210 | Copa Vino L | 55 cl | 230 mm |
| 192200 | Copa Vino M | 44 cl | 216 mm |
| 192341 | Copa Vino S | 35 cl | 160 mm |
| 192340 | Copa Vino XS | 19 cl | 160 mm |
| 192343 | Copa Cava | 23 cl | 235 mm |



| Código | Descripción | Capacidad | Altura |
|--------|-----------------|-----------|--------|
| 192346 | Vaso Cooler | 43 cl | 145 mm |
| 192345 | Vaso Long Drink | 39 cl | 129 mm |
| 192344 | Vaso D.O.F. | 38 cl | 100 mm |





V1093



V1092



V1091



V1090



V1089

| Código | Descripción | Capacidad | Altura |
|--------|--------------------|-----------|--------|
| V1093 | Copa Vino Victoria | 58 cl | 230 mm |
| V1092 | Copa Vino Victoria | 47 cl | 221 mm |
| V1091 | Copa Vino Victoria | 35 cl | 202 mm |
| V1090 | Copa Vino Victoria | 25 cl | 182 mm |
| V1089 | Copa Cava Victoria | 17 cl | 192 mm |





V1082



V1083



V1084



V1085



V1086

| Código | Descripción | Capacidad | Altura |
|--------|-------------------|-----------|--------|
| V1082 | Copa Platine Vino | 58 cl | 230 mm |
| V1083 | Copa Platine Vino | 44 cl | 220 mm |
| V1084 | Copa Platine Vino | 31 cl | 202 mm |
| V1085 | Copa Platine Vino | 25 cl | 182 mm |
| V1086 | Copa Platine Cava | 17 cl | 205 mm |



Mencia



V0265



V0264



V0263



V0262



V0290

| Código | Descripción | Capacidad | Altura |
|--------|------------------|-----------|--------|
| V0265 | Copa Mencia Vino | 58 cl | 235 mm |
| V0264 | Copa Mencia Vino | 44 cl | 230 mm |
| V0263 | Copa Mencia Vino | 31 cl | 208 mm |
| V0262 | Copa Mencia Vino | 25 cl | 192 mm |
| V0290 | Copa Mencia Cava | 17 cl | 205 mm |



Syrah



V0176



V0177



V0178



V0179



V0180

| Código | Descripción | Capacidad | Altura |
|--------|-----------------|-----------|----------|
| V0176 | Copa Syrah Vino | 58 cl | 230 mm |
| V0177 | Copa Syrah Vino | 47 cl | 220,5 mm |
| V0178 | Copa Syrah Vino | 35 cl | 202 mm |
| V0179 | Copa Syrah Vino | 25 cl | 182 mm |
| V0180 | Copa Syrah Cava | 17 cl | 192 mm |





V0759



V0758



V0757



V0755



V0754

| Código | Descripción | Capacidad | Altura |
|--------|-------------------|-----------|--------|
| V0759 | Copa Vino Vintage | 56 cl | 217 mm |
| V0758 | Copa Vino Vintage | 42 cl | 205 mm |
| V0757 | Copa Vino Vintage | 25 cl | 187 mm |
| V0755 | Copa Vino Vintage | 20 cl | 180 mm |
| V0754 | Copa Cava Vintage | 19 cl | 210 mm |



Primary

ARCOROC

| Código | Descripción | Capacidad | Altura |
|---------|-------------|-----------|--------|
| 9275725 | Vaso Bajo | 27 cl | 93 mm |
| 9275724 | Vaso Alto | 36 cl | 100 mm |
| 9275723 | Vaso Alto | 44 cl | 105 mm |



Lima



| Código | Descripción | Capacidad | Altura |
|---------|-------------|-----------|--------|
| 9122356 | Vaso Alto | 45 cl | 160 mm |
| 9293368 | Vaso Alto | 38 cl | 110 mm |
| 9293367 | Vaso Bajo | 35 cl | 80 mm |



Prysm



| Código | Descripción | Capacidad | Altura |
|---------|-------------|-----------|--------|
| 9221513 | Vaso Alto | 35 cl | 125 mm |
| 9221514 | Vaso Bajo | 37 cl | 96 mm |
| 9221515 | Vaso Bajo | 27 cl | 88 mm |





| Código | Descripción | Capacidad | Altura |
|---------|--------------------|-----------|--------|
| 1031238 | Vaso Alto | 65 cl | 178 mm |
| 8838939 | Vaso Alto | 46 cl | 160 mm |
| 1031236 | Vaso Alto | 42 cl | 130 mm |
| 8829903 | Vaso Alto | 35 cl | 122 mm |
| 8829878 | Vaso Alto Estrecho | 31 cl | 140 mm |
| 1031232 | Vaso Alto Estrecho | 20 cl | 137 mm |
| 1031233 | Vaso Bajo | 27 cl | 98 mm |
| 1121805 | Vaso Bajo | 20 cl | 81 mm |
| 1031231 | Vaso Bajo | 16 cl | 73 mm |



Princesa

| Código | Descripción | Capacidad | Altura |
|---------|-------------|-----------|--------|
| 1121636 | Vaso Alto | 43 cl | 163 mm |
| 1121321 | Vaso Alto | 34 cl | 148 mm |
| 1121357 | Vaso Alto | 28 cl | 127 mm |
| 1031242 | Vaso Alto | 24 cl | 110 mm |
| 1031241 | Vaso Alto | 18 cl | 127 mm |
| 1031245 | Vaso Bajo | 32 cl | 79 mm |
| 8850778 | Vaso Bajo | 22 cl | 79 mm |

Islande



| Código | Descripción | Capacidad | Altura |
|---------|-------------|-----------|--------|
| 1031157 | Vaso Alto | 36 cl | 170 mm |
| 10067 | Vaso Alto | 33 cl | 157 mm |
| 1031154 | Vaso Alto | 31 cl | 166 mm |
| 1031152 | Vaso Alto | 16 cl | 100 mm |
| 1121555 | Vaso Alto | 10 cl | 87 mm |
| 10068 | Vaso Bajo | 38 cl | 96 mm |
| 1031155 | Vaso Bajo | 30 cl | 93 mm |
| 1031153 | Vaso Bajo | 20 cl | 84 mm |

Banquet



SCHOTT
ZWIESEL

Tritan®
International patent

| Código | Descripción | Capacidad | Altura |
|--------|-------------|-----------|--------|
| 128089 | Vaso Alto | 54 cl | 156 mm |
| 974258 | Vaso Alto | 42 cl | 142 mm |
| 974244 | Vaso Alto | 32 cl | 120 mm |
| 128075 | Vaso Bajo | 40 cl | 85 mm |
| 978483 | Vaso Bajo | 33 cl | 83 mm |
| 974261 | Vaso Bajo | 26 cl | 81 mm |



Viña



| Código | Descripción | Capacidad | Altura |
|--------|-------------|-----------|--------|
| 114674 | Vaso Alto | 56 cl | 127 mm |
| 114672 | Vaso Bajo | 60 cl | 101 mm |



Pure



| Código | Descripción | Capacidad | Altura |
|--------|-------------|-----------|--------|
| 112419 | Vaso Alto | 54 cl | 165 mm |
| 113771 | Vaso Alto | 36 cl | 144 mm |
| 112841 | Vaso Alto | 25 cl | 140 mm |
| 112417 | Vaso Bajo | 39 cl | 90 mm |
| 112844 | Vaso Bajo | 31 cl | 83 mm |





Cristalino



| Código | Descripción | Capacidad | Altura |
|---------|--------------------|-----------|--------|
| 4527214 | Vaso Tumbler verde | 470 ml | 120 mm |
| 4527314 | Vaso Tumbler ámbar | 470 ml | 120 mm |
| 4527014 | Vaso Tumbler azul | 470 ml | 120 mm |
| 4527114 | Vaso Tumbler rojo | 470 ml | 120 mm |



| Código | Descripción | Capacidad | Altura |
|-----------|---------------------------|-----------|--------|
| 3527312-E | Vaso Elements ámbar | 465 ml | 120 mm |
| 3527112-E | Vaso Elements rojo | 465 ml | 120 mm |
| 3528112-E | Vaso Elements lila | 465 ml | 120 mm |
| 3527712-E | Vaso Elements rosa | 465 ml | 120 mm |
| 3527012-E | Vaso Elements azul | 465 ml | 120 mm |
| 3527912-E | Vaso Elements azul claro | 465 ml | 120 mm |
| 3527812-E | Vaso Elements gris | 465 ml | 120 mm |
| 3527512-E | Vaso Elements marrón | 465 ml | 120 mm |
| 3527612-E | Vaso Elements verde oliva | 465 ml | 120 mm |
| 3527212-E | Vaso Elements verde | 465 ml | 120 mm |



| Código | Descripción | Capacidad | Altura |
|-----------|--------------------------|-----------|--------|
| 3527512-T | Vaso Twister marrón | 465 ml | 120 mm |
| 3527612-T | Vaso Twister verde oliva | 465 ml | 120 mm |
| 3527912-T | Vaso Twister azul | 465 ml | 120 mm |
| 3527812-T | Vaso Twister gris | 465 ml | 120 mm |
| 3527212-T | Vaso Twister verde | 465 ml | 120 mm |
| 3527312-T | Vaso Twister ámbar | 465 ml | 120 mm |
| 3527712-T | Vaso Twister rosa | 465 ml | 120 mm |



Iceberg



| Código | Descripción | Capacidad | Altura |
|--------|-------------|-----------|--------|
| 956069 | Vaso Alto | 48 cl | 160 mm |
| 956055 | Vaso Bajo | 40 cl | 95 mm |



París

| Código | Descripción | Capacidad | Altura |
|--------|----------------|-----------|--------|
| 577705 | Vaso Alto N-79 | 33 cl | 156 mm |
| 571703 | Vaso Alto N-42 | 27 cl | 142 mm |
| 813893 | Vaso Alto N-12 | 24 cl | 117 mm |
| 579704 | Vaso Bajo N-60 | 28 cl | 80 mm |
| 575706 | Vaso Bajo N-89 | 15 cl | 62 mm |

Ypsilon

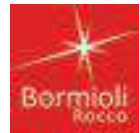

| Código | Descripción | Capacidad | Altura |
|--------|------------------------|-----------|--------|
| 125140 | Vaso Alto Cooler | 43,5 cl | 175 mm |
| 125030 | Vaso Alto Long Drink | 31,8 cl | 160 mm |
| 157120 | Vaso Alto Long Drink | 24 cl | 140 mm |
| 125060 | Vaso Bajo Dof | 35,5 cl | 117 mm |
| 125020 | Vaso Bajo Pre Dinner | 25,5 cl | 107 mm |
| 125040 | Vaso Bajo After Dinner | 15 cl | 95 mm |

Vega



| Código | Descripción | Capacidad | Altura |
|--------|-----------------|-----------|--------|
| 340340 | Vaso Alto Vega | 32 cl | 112 mm |
| 430410 | Vaso Medio Vega | 22 cl | 100 mm |
| 430400 | Vaso Bajo Vega | 11 cl | 80 mm |

Endeavor



Libbey
GLASSWARE



| Código | Descripción | Capacidad | Altura |
|--------|-------------------------|-----------|--------|
| 15714 | Vaso Alto Beverage | 41,4 cl | 168 mm |
| 15712 | Vaso Alto Beverage | 35,5 cl | 160 mm |
| 15711 | Vaso Alto Hi-Ball | 29,6 cl | 159 mm |
| 15712 | Vaso Bajo Old Fashioned | 35,5 cl | 105 mm |
| 15710 | Vaso Bajo Rocks | 26,6 cl | 98 mm |
| 15709 | Vaso Bajo Rocks | 20,7 cl | 92 mm |
| 15733 | Vaso Bajo Espresso | 11 cl | 76 mm |



Diamond



Código

350250
302257
350210

Código

350260
302259
350220

Código

350270
302258
350230

| Código | Descripción | Capacidad | Altura |
|--------|-------------|-----------|----------|
| 350240 | Vaso Cooler | 47 cl | 143,5 mm |
| 302260 | Vaso D.O.F. | 38,5 cl | 102,5 mm |
| 350200 | Vaso | 30,5 cl | 92,5 mm |



Syrah



| Código | Descripción | Capacidad | Altura |
|--------|-------------|-----------|--------|
| V0244 | Vaso Alto | 47 cl | 109 mm |
| V0245 | Vaso Bajo | 35 cl | 99 mm |

Jerte



| Código | Descripción | Capacidad | Altura |
|--------|-----------------|-----------|----------|
| V1063 | Vaso Alto Jerte | 62 cl | 144,5 mm |
| V1064 | Vaso Bajo Jerte | 49 cl | 114 mm |

Inverness

Libbey
GLASSWARE

| Código | Descripción | Capacidad |
|-----------|-------------------|-----------|
| V76215479 | Vaso Alto | 41,4 cl |
| V76215482 | Vaso Bajo | 37 cl |
| V76215485 | Vaso Alto Hi-Ball | 26,6 cl |



Bravura



| Código | Descripción | Capacidad | Altura |
|--------|-------------|-----------|--------|
| 2212 | Vaso Alto | 49,5 cl | 159 mm |
| 2211 | Vaso Bajo | 36,2 cl | 102 mm |



Quartz



| Código | Descripción | Capacidad | Altura |
|------------|------------------|-----------|----------|
| VV20534249 | Vaso Alto Quartz | 47 cl | 16 cm |
| VV20534238 | Vaso Bajo Quartz | 33 cl | 10,25 cm |
| 20534230 | Vaso Alto Quartz | 30 cl | 15,6 cm |
| 20534225 | Vaso Bajo Quartz | 25 cl | 9,5 cm |

Durobor®



| Código | Descripción | Capacidad | Altura |
|--------|------------------------|-----------|--------|
| 15244 | Vaso Alto Beverage | 41,4 cl | 130 mm |
| 15238 | Vaso Alto Beverage | 35,5 cl | 123 mm |
| 15236 | Vaso Alto Hi-Ball | 26,6 cl | 118 mm |
| 15239 | Vaso Alto Hi-Ball | 20,7 cl | 115 mm |
| 15243 | Vaso Bajo Double Rocks | 35,5 cl | 100 mm |
| 15232 | Vaso Bajo Rocks | 29,6 cl | 96 mm |
| 15241 | Vaso Bajo Rocks | 20,7 cl | 79 mm |

Durobor



| Código | Descripción | Capacidad | Altura |
|------------|--------------|-----------|---------|
| V20534705 | Vaso Chupito | 5 cl | 9,2 cm |
| V20534709 | Vaso Bajo | 9 cl | 9,2 cm |
| V20534715 | Vaso Bajo | 15 cl | 7 cm |
| V20534721 | Vaso Bajo | 20 cl | 8,5 cm |
| V20534729 | Vaso Bajo | 29 cl | 9,3 cm |
| V20534730 | Vaso Tubo | 30 cl | 17,3 cm |
| V20534734 | Vaso Tubo | 34 cl | 14 cm |
| VV20534731 | Vaso Bajo | 31 cl | 9,8 cm |
| VV20534750 | Vaso Bajo | 50 cl | 16 cm |

Disco



Básicos



| Código | Descripción | Capacidad | Altura |
|--------|-------------|-----------|--------|
| 410610 | Vaso Caña | 47,6 cl | 149 mm |
| 410590 | Vaso Caña | 21,5 cl | 104 mm |
| 410580 | Vaso Caña | 17,7 cl | 98 mm |
| 410570 | Vaso Caña | 14,1 cl | 109 mm |
| 410620 | Vaso Caña | 8,9 cl | 86 mm |



| Código | Descripción | Capacidad | Altura |
|--------|---------------|-----------|--------|
| V0055 | Vaso Sidra | 50 cl | 121 mm |
| V0191 | Vaso Pinta | 36 cl | 89 mm |
| V0203 | Vaso Chiquito | 23 cl | 59 mm |



| Código | Descripción | Capacidad | Altura |
|--------|-------------|-----------|--------|
| V0034 | Vaso Tubo | 31 cl | 164 mm |
| V0036 | Vaso Tubo | 27 cl | 163 mm |
| V0043 | Vaso Tubo | 25 cl | 150 mm |





Belagua

| Código | Descripción | Capacidad | Altura |
|--------|--------------|-----------|--------|
| V0384 | Vaso Cerveza | 56 cl | 150 mm |
| V0398 | Vaso Cerveza | 47 cl | 145 mm |
| V0386 | Vaso Cerveza | 33 cl | 134 mm |



Conil

| Código | Descripción | Capacidad | Altura |
|--------|--------------|-----------|--------|
| V0225 | Vaso Cerveza | 56 cl | 150 mm |
| V0224 | Vaso Cerveza | 47 cl | 145 mm |
| V0223 | Vaso Cerveza | 33 cl | 134 mm |
| V0222 | Vaso Cerveza | 28 cl | 119 mm |
| V0221 | Vaso Cerveza | 22 cl | 105 mm |



Nonic

| Código | Descripción | Capacidad | Altura |
|---------|--------------|-----------|--------|
| 8804137 | Vaso Cerveza | 66 cl | 159 mm |
| 1031107 | Vaso Cerveza | 57 cl | 152 mm |
| 1031103 | Vaso Cerveza | 34 cl | 127 mm |
| 1031104 | Vaso Cerveza | 28 cl | 115 mm |



Executive

| Código | Descripción | Capacidad | Altura |
|--------|--------------|-----------|--------|
| 128550 | Copa Cerveza | 53 cl | 205 mm |
| 128540 | Copa Cerveza | 39 cl | 186 mm |
| 128530 | Copa Cerveza | 26 cl | 167 mm |



Harmonía

| Código | Descripción | Capacidad | Altura |
|--------|--------------|-----------|--------|
| 128550 | Vaso Cerveza | 53 cl | 205 mm |
| 128540 | Vaso Cerveza | 39 cl | 186 mm |
| 128530 | Vaso Cerveza | 26 cl | 167 mm |



Palladio

| Código | Descripción | Capacidad | Altura |
|--------|--------------|-----------|--------|
| 165280 | Vaso Cerveza | 54 cl | 278 mm |
| 165270 | Vaso Cerveza | 38 cl | 238 mm |
| 165260 | Vaso Cerveza | 28 cl | 208 mm |



Abadía

| Código | Descripción | Capacidad | Altura |
|--------|--------------|-----------|--------|
| V0287 | Copa Cerveza | 42 cl | 169 mm |
| V0286 | Copa Cerveza | 29 cl | 150 mm |



Dunkel

| Código | Descripción | Capacidad | Altura |
|--------|--------------|-----------|--------|
| V0882 | Vaso Cerveza | 38 cl | 182 mm |
| V0881 | Vaso Cerveza | 28 cl | 165 mm |



Toscana

| Código | Descripción | Capacidad | Altura |
|--------|--------------|-----------|--------|
| V0294 | Copa Cerveza | 62 cl | 157 mm |
| V0293 | Copa Cerveza | 41 cl | 145 mm |

Cerveza



Alemana

| Código | Descripción | Capacidad | Altura |
|---------|--------------|-----------|--------|
| 1051973 | Copa Cerveza | 44 cl | 164 mm |
| 1051972 | Copa Cerveza | 29 cl | 157 mm |



Cervoise

| Código | Descripción | Capacidad | Altura |
|---------|--------------|-----------|--------|
| 8824941 | Copa Cerveza | 62 cl | 207 mm |
| 8807131 | Copa Cerveza | 50 cl | 191 mm |
| 1031142 | Copa Cerveza | 38 cl | 179 mm |
| 1031141 | Copa Cerveza | 32 cl | 166 mm |
| 1031140 | Copa Cerveza | 26 cl | 156 mm |



Martigues

| Código | Descripción | Capacidad | Altura |
|---------|--------------|-----------|--------|
| 1031145 | Vaso Cerveza | 33 cl | 150 mm |
| 8818603 | Vaso Cerveza | 16 cl | 123 mm |



Malta

| Código | Descripción | Capacidad | Altura |
|--------|--------------|-----------|--------|
| V0278 | Copa Cerveza | 56 cl | 173 mm |
| V0273 | Copa Cerveza | 44 cl | 157 mm |
| V0277 | Copa Cerveza | 33 cl | 147 mm |



G. Servicio

| Código | Descripción | Capacidad | Altura |
|---------|--------------|-----------|--------|
| 1051647 | Copa Cerveza | 60 cl | 168 mm |
| 1051646 | Copa Cerveza | 41 cl | 147 mm |



Príncipe

| Código | Descripción | Capacidad | Altura |
|-----------|--------------|-----------|--------|
| 3163LCP48 | Vaso Cerveza | 48,5 cl | 214 mm |
| 3163LCP37 | Vaso Cerveza | 37 cl | 204 mm |
| 3163LCP30 | Vaso Cerveza | 30 cl | 194 mm |
| 3163LCP25 | Vaso Cerveza | 25 cl | 172 mm |



Baviera

| Código | Descripción | Capacidad | Altura |
|--------|---------------|-----------|--------|
| 133450 | Jarra Cerveza | 69 cl | 197 mm |
| 133440 | Jarra Cerveza | 50 cl | 183 mm |
| 133430 | Jarra Cerveza | 38 cl | 168 mm |
| 133420 | Jarra Cerveza | 26 cl | 153 mm |



Britania

| Código | Descripción | Capacidad | Altura |
|---------|---------------|-----------|--------|
| 1006067 | Jarra Cerveza | 56 cl | 125 mm |
| 1221101 | Jarra Cerveza | 28 cl | 96 mm |



Haworth

| Código | Descripción | Capacidad | Altura |
|---------|---------------|-----------|--------|
| 1221098 | Jarra Cerveza | 56 cl | 130 mm |
| 1121307 | Jarra Cerveza | 28 cl | 103 mm |



Pure

| Código | Descripción | Capacidad | Altura |
|--------|---------------|-----------|--------|
| 113755 | Copa Cocktail | 34 cl | 180 mm |



Mondial

| Código | Descripción | Capacidad | Altura |
|--------|---------------|-----------|--------|
| 185534 | Copa Cocktail | 24 cl | 170 mm |



Cóctel Saucer

| Código | Descripción | Capacidad | Altura |
|--------|---------------|-----------|--------|
| 115840 | Copa Cocktail | 25,9 cl | 129 mm |



Cabernet Cocktail

| Código | Descripción | Capacidad | Altura |
|---------|---------------|-----------|--------|
| 9222972 | Copa Cocktail | 21 cl | 172 mm |
| 8862449 | Copa Cocktail | 30 cl | 188 mm |



Margarita

| Código | Descripción | Capacidad | Altura |
|---------|---------------|-----------|--------|
| 8879921 | Copa Cocktail | 27 cl | 106 mm |
| 8862447 | Copa Cocktail | 44 cl | 192 mm |



Hurricane

| Código | Descripción | Capacidad | Altura |
|---------|---------------|-----------|--------|
| 8854584 | Copa Cocktail | 44 cl | 208 mm |
| 8810770 | Copa Cocktail | 25 cl | 195 mm |



Cóctel



Ypsilon Cocktail

| Código | Descripción | Capacidad | Altura |
|--------|---------------|-----------|--------|
| 122490 | Copa Cocktail | 24,5 cl | 182 mm |
| 149820 | Copa Cocktail | 12,5 cl | 145 mm |



Diamante

| Código | Descripción | Capacidad | Altura |
|--------|---------------|-----------|--------|
| 166131 | Copa Cocktail | 17 cl | 151 mm |



Z-STEM

| Código | Descripción | Capacidad | Altura |
|--------|---------------|-----------|--------|
| 37719 | Copa Cocktail | 15 cl | 136 mm |
| 37339 | Copa Cocktail | 22 cl | 162 mm |
| 37799 | Copa Cocktail | 27 cl | 165 mm |



Fountainware

| Código | Descripción | Capacidad | Altura |
|--------|---------------|-----------|--------|
| 5110 | Vaso Cocktail | 35 cl | 190 mm |



Cosmopolitan

| Código | Descripción | Capacidad | Altura |
|--------|---------------|-----------|--------|
| 400 | Vaso Cocktail | 24 cl | 100 mm |



Vintage

| Código | Descripción | Capacidad | Altura |
|----------|---------------|-----------|--------|
| CO6587CV | Copa Cocktail | 28 cl | 168 mm |



Classic

| Código | Descripción | Capacidad | Altura |
|----------|---------------|-----------|--------|
| CO6587CP | Copa Cocktail | 17 cl | 170 mm |
| CO6587CP | Copa Cocktail | 21 cl | 183 mm |



Xarel

| Código | Descripción | Capacidad | Altura |
|--------|---------------|-----------|--------|
| V0201 | Copa Cocktail | 17 cl | 221 mm |



Chardonnay

| Código | Descripción | Capacidad | Altura |
|--------|---------------|-----------|--------|
| V0403 | Copa Cocktail | 21 cl | 221 mm |



Subirats

| Código | Descripción | Capacidad | Altura |
|--------|---------------|-----------|----------|
| V0317 | Copa Cocktail | 17 cl | 194,5 mm |

Coñac



Gran Coñac

| Código | Descripción | Capacidad | Altura |
|---------|-------------|-----------|--------|
| 9306757 | Copa | 77 cl | 111 mm |



Coñac Degustación

| Código | Descripción | Capacidad | Altura |
|---------|-------------|-----------|--------|
| 10070 | Copa | 41 cl | 129 mm |
| 10069 | Copa | 25 cl | 112 mm |
| 1031147 | Copa | 15 cl | 96 mm |



Coñac

| Código | Descripción | Capacidad | Altura |
|--------|-------------|-----------|---------|
| V1964 | Copa | 30 cl | 116 mm |
| V1962 | Copa | 25 cl | 110 mm |
| V0821 | Copa | 20 cl | 105 mm |
| V0743 | Copa | 15 cl | 98 mm |
| V0187 | Copa | 10 cl | 90,5 mm |



Mondial

| Código | Descripción | Capacidad | Altura |
|--------|-------------|-----------|--------|
| 133948 | Copa | 51 cl | 147 mm |



Open Up

| Código | Descripción | Capacidad | Altura |
|---------|-------------|-----------|--------|
| 9261059 | Copa | 39 cl | 132 mm |



Pure

| Código | Descripción | Capacidad | Altura |
|--------|-------------|-----------|--------|
| 113756 | Copa | 62 cl | 171 mm |

Catavinos



Viticole

| Código | Descripción | Capacidad | Altura |
|---------|-------------|-----------|--------|
| 8819010 | Copa | 40 cl | 200 mm |
| 8842257 | Copa | 31 cl | 175 mm |
| 8837266 | Copa | 21,5 cl | 155 mm |
| 7742258 | Copa | 12 cl | 131 mm |



Arc

| Código | Descripción | Capacidad | Altura |
|---------|-------------|-----------|--------|
| 9238708 | Copa | 15,5 cl | 151 mm |



Catavinos

| Código | Descripción | Capacidad | Altura |
|--------|-------------|-----------|--------|
| V0247 | Copa | 21 cl | 155 mm |
| V0246 | Copa | 15,5 cl | 151 mm |

Frascas



Frasca Cuadrada

| Código | Descripción | Capacidad | Altura |
|---------|-------------|-----------|--------|
| 1012014 | Frasca | 2 L | 200 mm |
| 1012002 | Frasca | 1 L | 175 mm |
| 1012000 | Frasca | 0,5 L | 155 mm |
| 1012001 | Frasca | 0,25 L | 131 mm |



Misura

| Código | Descripción | Capacidad | Altura |
|--------|-------------|-----------|--------|
| 184179 | Frasca | 100 cl | 262 mm |
| 184169 | Frasca | 50 cl | 235 mm |
| 184159 | Frasca | 25 cl | 190 mm |



Ypsilon

| Código | Descripción | Capacidad | Altura |
|--------|-------------|-----------|--------|
| 125000 | Frasca | 108 cl | 255 mm |
| 125080 | Frasca | 55 cl | 204 mm |
| 128070 | Frasca | 29 cl | 165 mm |

Helado



Sorbet

| Código | Descripción | Capacidad | Altura |
|---------|-------------|-----------|--------|
| 8843121 | Copa | 38 cl | 94 mm |
| 1121308 | Copa | 21 cl | 78 mm |



Pepite

| Código | Descripción | Capacidad | Altura |
|---------|-------------|-----------|--------|
| 8853496 | Copa | 20 cl | 60 mm |



Glacé

| Código | Descripción | Capacidad | Altura |
|---------|-------------|-----------|--------|
| 1032173 | Copa | 21 cl | 127 mm |



Palmier

| Código | Descripción | Capacidad | Altura |
|---------|-------------|-----------|--------|
| 1121624 | Copa | 37 cl | 201 mm |
| 8858010 | Copa | 21 cl | 101 mm |



Jazzed

| Código | Descripción | Capacidad | Altura |
|---------|-------------|-----------|--------|
| 9126753 | Copa | 25 cl | 92 mm |



Catalina

| Código | Descripción | Capacidad | Altura |
|--------|-------------|-----------|--------|
| 3825 | Copa | 30 cl | 100 mm |



Deliss

| Código | Descripción | Capacidad | Altura |
|-----------|-------------|-----------|--------|
| V14033021 | Copa | 225 cc | 140 mm |



Dune

| Código | Descripción | Capacidad | Altura |
|-----------|-------------|-----------|--------|
| V14080020 | Copa | 270 cc | 120 mm |



Vértigo

| Código | Descripción | Capacidad | Altura |
|-----------|-------------|-----------|--------|
| V20579737 | Vaso | 370 cc | 65 mm |
| V20579722 | Vaso | 220 cc | 55 mm |
| V20579712 | Vaso | 120 cc | 50 mm |



Primavera

| Código | Descripción | Capacidad | Altura |
|---------|-------------|-----------|--------|
| 1121624 | Copa | 37 cl | 201 mm |



Jerba

| Código | Descripción | Capacidad | Altura |
|--------|-------------|-----------|--------|
| 134630 | Copa | 36 cl | 140 mm |



Ypsilon

| Código | Descripción | Capacidad | Altura |
|--------|-------------|-----------|--------|
| 340750 | Copa | 37 cl | 90 mm |



Acapulco

| Código | Descripción | Capacidad | Altura |
|--------|-------------|-----------|--------|
| 134010 | Copa | 30 cl | 125 mm |
| 134080 | Copa | 17,5 cl | 105 mm |



Gelatto

| Código | Descripción | Capacidad | Altura |
|--------|-------------|-----------|--------|
| 133990 | Copa | 28 cl | 166 mm |



Fortuna

| Código | Descripción | Capacidad | Altura |
|--------|-------------|-----------|--------|
| 191410 | Copa | 30 cl | 180 mm |



Combinados



Giona

| Código | Descripción | Capacidad | Altura |
|---------|-------------|-----------|--------|
| CO6587 | Copa | 81 cl | 210 mm |
| CO6587N | Copa | 81 cl | 210 mm |



Barman - Gran Barman

| Código | Descripción | Capacidad | Altura |
|----------|------------------|-----------|--------|
| CO69799B | Copa Barman | 62 cl | 185 mm |
| CO6799GB | Copa Gran Barman | 62 cl | 210 mm |



Party

| Código | Descripción | Capacidad | Altura |
|---------|-------------|-----------|--------|
| 9126460 | Copa | 62 cl | 200 mm |



Havana

| Código | Descripción | Capacidad | Altura |
|--------|-------------|-----------|--------|
| V0093 | Copa | 62 cl | 195 mm |
| V0095 | Copa | 41 cl | 170 mm |



London

| Código | Descripción | Capacidad | Altura |
|--------|-------------|-----------|--------|
| V0219 | Copa | 64 cl | 221 mm |



Peak

| Código | Descripción | Capacidad | Altura |
|---------|-------------|-----------|--------|
| 7144090 | Copa | 72 cl | 225 mm |



Vodka Plus

| Código | Descripción | Capacidad | Altura |
|---------|-------------|-----------|--------|
| 9225560 | Copa | 72 cl | 255 mm |



VB22299

Misket

| Código | Descripción | Capacidad | Altura |
|---------|-------------|-----------|--------|
| VB22299 | Copa | 64,5 cl | 200 mm |
| VA22299 | Copa | 64,5 cl | 200 mm |
| VR22299 | Copa | 64,5 cl | 200 mm |
| W22299 | Copa | 64,5 cl | 200 mm |
| VX22299 | Copa | 64,5 cl | 200 mm |
| VN22299 | Copa | 64,5 cl | 200 mm |



VA22299

VR22299

VV22299



VX22299

VN22299



Irish Coffee

| Código | Descripción | Capacidad | Altura |
|---------|-------------|-----------|--------|
| 8811874 | Copa | 24 cl | 139 mm |



Oslo

| Código | Descripción | Capacidad | Altura |
|--------|----------------|-----------|--------|
| 121870 | Taza Multiuso | 32 cl | 107 mm |
| 121880 | Taza Capuchino | 22 cl | 96 mm |
| 121890 | Taza Café | 10 cl | 62 mm |



Ypsilon

| Código | Descripción | Capacidad | Altura |
|--------|----------------|-----------|--------|
| 340340 | Taza Té | 32 cl | 112 mm |
| 340330 | Taza Capuchino | 22 cl | 100 mm |
| 340320 | Taza Café | 11 cl | 80 mm |



Carajillo

| Código | Descripción | Capacidad | Altura |
|---------|-------------|-----------|--------|
| 1051677 | Vaso | 11 cl | 67 mm |



Aroma

| Código | Descripción | Capacidad | Altura |
|---------|-------------|-----------|--------|
| 9231511 | Taza | 22 cl | 85 mm |
| 9231360 | Taza | 8 cl | 64 mm |



Barista

| Código | Descripción | Capacidad | Altura |
|------------|-------------|-----------|----------|
| V205879512 | Vaso | 120 cc | 8,5 cm |
| V205879522 | Vaso | 220 cc | 13,65 cm |



Bombón

| Código | Descripción | Capacidad | Altura |
|--------|-------------|-----------|--------|
| 121890 | Vaso | 13 cl | 77 mm |



Colombia

| Código | Descripción | Capacidad | Altura |
|--------|-------------|-----------|---------|
| V0285 | Vaso | 18 cl | 84,4 mm |
| V0292 | Vaso | 13 cl | 77 mm |
| V0284 | Vaso | 11 cl | 70 mm |



Saturn

| Código | Descripción | Capacidad | Altura |
|---------|------------------|-----------|--------|
| B803001 | Mug borosilicato | 29 cl | 11 cm |



Venus

| Código | Descripción | Capacidad | Altura |
|---------|-----------------------------|-----------|--------|
| B803006 | Taza Capuchino borosilicato | 20 cl | 100 mm |
| B803007 | Taza Café borosilicato | 8 cl | 65 mm |



Jarras



Pichet

| Código | Descripción | Capacidad | Altura |
|---------|-------------|-----------|--------|
| 9230214 | Jarra | 130 cl | 199 mm |
| 9230215 | Jarra | 50 cl | 153 mm |



Arc

| Código | Descripción | Capacidad | Altura |
|---------|-------------|-----------|--------|
| 9227254 | Jarra | 130 cl | 217 mm |
| 9227255 | Jarra | 100 cl | 202 mm |
| 9227258 | Jarra | 50 cl | 146 mm |



Sangría

| Código | Descripción | Capacidad | Altura |
|---------|-------------|-----------|--------|
| 1013006 | Jarra | 175 cl | 220 mm |
| 1013001 | Jarra | 150 cl | 200 mm |
| 1013002 | Jarra | 125 cl | 190 mm |
| 1013003 | Jarra | 100 cl | 180 mm |



Bistrot

| Código | Descripción | Capacidad | Altura |
|--------|-------------|-----------|--------|
| 146160 | Jarra | 115 cl | 186 mm |
| 146150 | Jarra | 60 cl | 145 mm |
| 146140 | Jarra | 30 cl | 115 mm |



Exclusiv

| Código | Descripción | Capacidad | Altura |
|----------|-------------|-----------|--------|
| 85154/85 | Jarra | 1,5 L | 213 mm |



Decantadores



Pure

| Código | Descripción | Capacidad | Altura |
|--------|-------------|-----------|--------|
| 113745 | Decantador | 75 cl | 271 mm |



Clásico

| Código | Descripción | Capacidad | Altura |
|--------|-------------|-----------|--------|
| 110727 | Decantador | 75 cl | 230 mm |



Electra

| Código | Descripción | Capacidad | Altura |
|--------|-------------|-----------|--------|
| 192347 | Decantador | 161 cl | 211 mm |



Open Up

| Código | Descripción | Capacidad | Altura |
|---------|-------------|-----------|--------|
| 9276653 | Decantador | 1,4 L | 314 mm |



Intuito

| Código | Descripción | Capacidad | Altura |
|---------|-------------|-----------|--------|
| 9203075 | Decantador | 1,75 L | 238 mm |



Chupito / Licor



Riserva Grappa

| Código | Descripción | Capacidad | Altura |
|--------|-------------|-----------|--------|
| 166181 | Copa | 8,1 cl | 163 mm |



Amaro

| Código | Descripción | Capacidad | Altura |
|-----------|-------------|-----------|--------|
| V20590907 | Copa licor | 70 cc | 153 mm |

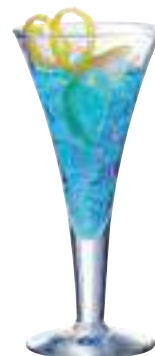

Royal

| Código | Descripción | Capacidad | Altura |
|------------|-------------|-----------|----------|
| V205191516 | Copa licor | 60 cc | 13,05 cm |



Dublino

| Código | Descripción | Capacidad | Altura |
|--------|--------------|-----------|--------|
| 168169 | Vaso chupito | 3,4 cl | 70 mm |
| 169249 | Vaso chupito | 5,7 cl | 90 mm |



Chupito

| Código | Descripción | Capacidad | Altura |
|--------|--------------|-----------|--------|
| V0187 | Vaso chupito | 4 cl | 47 mm |



Disco

| Código | Descripción | Capacidad | Altura |
|----------|--------------|-----------|--------|
| 20534705 | Vaso chupito | 5 cl | 67 mm |



Fiore Schnaps

| Código | Descripción | Capacidad | Altura |
|--------|--------------|-----------|--------|
| 129090 | Vaso chupito | 5,5 cl | 145 mm |



Islande

| Código | Descripción | Capacidad | Altura |
|---------|--------------|-----------|--------|
| 1031151 | Vaso chupito | 6 cl | 105 mm |



Pisa

| Código | Descripción | Capacidad | Altura |
|-----------|--------------|-----------|--------|
| V11006520 | Vaso chupito | 5 cl | 57 mm |



Granity

| Código | Descripción | Capacidad | Altura |
|---------|--------------|-----------|--------|
| 8804755 | Vaso chupito | 4,5 cl | 57 mm |



Conic

| Código | Descripción | Capacidad | Altura |
|-----------|--------------|-----------|--------|
| V11109522 | Vaso chupito | 55 cc | 70 mm |



Limoncino

| Código | Descripción | Capacidad | Altura |
|--------|--------------|-----------|--------|
| 128940 | Vaso chupito | 6 cl | 115 mm |

Ensaladeras



Apilable

| Código | Descripción | Capacidad | Tamaño |
|---------|-------------|-----------|--------|
| 8810011 | Ensaladera | 3,5 cl | 6 cm |
| 8810018 | Ensaladera | 7,5 cl | 7 cm |
| 8810040 | Ensaladera | 15 cl | 9 cm |
| 8810019 | Ensaladera | 24 cl | 10 cm |
| 8810000 | Ensaladera | 38 cl | 12 cm |
| 8810003 | Ensaladera | 62 cl | 14 cm |
| 8810027 | Ensaladera | 110 cl | 17 cm |
| 1121974 | Ensaladera | 180 cl | 20 cm |
| 1121975 | Ensaladera | 390 cl | 23 cm |
| 1121976 | Ensaladera | 430 cl | 26 cm |
| 1221148 | Ensaladera | 600 cl | 29 cm |



Mr. Chef

| Código | Descripción | Capacidad | Tamaño |
|--------|-------------|-----------|--------|
| 500000 | Ensaladera | 8 cl | 9 cm |
| 500010 | Ensaladera | 18 cl | 11 cm |
| 500020 | Ensaladera | 36 cl | 14 cm |
| 500030 | Ensaladera | 75 cl | 17 cm |
| 500040 | Ensaladera | 160 cl | 22 cm |
| 500050 | Ensaladera | 256 cl | 26 cm |
| 500060 | Ensaladera | 396 cl | 30 cm |



Practica

| Código | Descripción | Tamaño |
|-----------|-------------|--------|
| V14065120 | Bowl | 10 cm |
| V14065220 | Bowl | 12 cm |
| V14065320 | Bowl | 14 cm |
| V14065520 | Bowl | 18 cm |
| V14065431 | Bowl | 23 cm |
| V14065631 | Bowl | 25 cm |

Ming Cristal

| Código | Descripción | Tamaño |
|--------|-------------|------------|
| B3174 | Bowl | 20x20x8 cm |
| B3175 | Bowl | 14x14x7 cm |
| B3176 | Bowl | 10x10x6 cm |
| B3177 | Bowl | 8x8x4,5 cm |



Apilable

| Código | Descripción | Altura |
|---------|-------------|--------|
| 1221102 | Cenicero | 85 mm |
| 9231320 | Cenicero | 107 mm |
| 8841471 | Cenicero | 145 mm |



Apilable Negro

| Código | Descripción | Altura |
|---------|-------------|--------|
| 1221099 | Cenicero | 85 mm |
| 1221116 | Cenicero | 107 mm |
| 8841473 | Cenicero | 145 mm |



Apilable Opal

| Código | Descripción | Altura |
|---------|-------------|--------|
| 8851254 | Cenicero | 85 mm |
| 1221118 | Cenicero | 107 mm |



Ceniceros





VISTA ALEGRE

 1824

| Código | Descripción | Capacidad | Altura |
|----------|-------------|-----------|--------|
| 49000000 | Copa Agua | 28 cl | 170 mm |
| 49000062 | Copa Vino | 21 cl | 153 mm |
| 49000070 | Copa Vino | 14 cl | 127 mm |
| 49000078 | Copa Licor | 5,5 cl | 101 mm |
| 49000086 | Copa Flauta | 11 cl | 190 mm |



CUBERTERÍA

Cutlery • Couverts • Posate • Besteck



Guía de tamaños



Cuchara mesa



Tenedor postre



Tenedor mesa



Cuchillo postre



Cuchillo mesa



Cuchara café

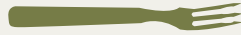

Tenedor chuletero



Tenedor lunch



Cuchillo chuletero



Cuchara moka



Cuchara postre



Pala pescado



Tenedor pescado



Cuidados de la cubertería

- Eliminar los restos de comida lo antes posible antes de proceder al lavado.
- No utilizar estropajos metálicos o sintéticos para evitar el rayado de la cubertería.
- No utilice detergentes excesivamente abrasivos.
- No utilizar productos de limpieza con base ácida, ni agua con exceso de cloro.
- Una vez efectuado el lavado a mano o en el lavavajillas, es muy importante secar cuidadosamente los cubiertos con un paño suave.
- Al introducir los cubiertos en el lavavajillas, le recomendamos que los cuchillos se pongan verticalmente con las hojas hacia arriba.
- Controlar que la toma de tierra del lavavajillas funcione correctamente. Un mal funcionamiento de la misma puede provocar descargas que dañen la cubertería.



X-LO

- ✓ 3,5 mm
- ✓ Pulido Espejo
- ✓ Inox 18/10

| Referencia | Descripción | ←→ mm | Box |
|------------|---------------------|-------|-----|
| 3090-1 | Tenedor Mesa | 220 | 12 |
| 3090-2 | Cuchara Mesa | 220 | 12 |
| 3090-5 | Cuchillo Mesa | 244 | 12 |
| 3090-45 | Cuchillo Chuletero | 244 | 12 |
| 3090-15 | Cuhara Postre | 193 | 12 |
| 3090-14 | Tenedor Postre | 193 | 12 |
| 3090-6 | Cuchillo Postre | 219 | 12 |
| 3090-3 | Cuchara café | 144 | 12 |
| 3090-26 | Cuchara moka | 110 | 12 |
| 3090-4 | Tenedor lunch | 141,5 | 12 |
| 3090-40 | Cuchillo Mantequero | 165 | 12 |
| 3090-16 | Tenedor Pescado | 182,5 | 12 |
| 3090-17 | Pala de Pescado | 208,5 | 12 |

eternum 
created 1924





Baguette

- √ 3 mm
- √ Pulido Espejo
- √ Inox 18/10

| Referencia | Descripción | ←→ mm | Box |
|------------|--------------------|-------|-----|
| 42001 | Cuchara Mesa | 205 | 12 |
| 42002 | Tenedor Mesa | 205 | 12 |
| 42003 | Cuchillo Mesa MB | 240 | 12 |
| 42033 | Cuchillo Chuletero | 240 | 12 |
| 42004 | Cuchara Postre | 185 | 12 |
| 42005 | Tenedor Postre | 185 | 12 |
| 42006 | Cuchillo Postre MB | 216 | 12 |
| 42007 | Cuchara Café | 145 | 12 |
| 42009 | Tenedor Lunch | 145 | 12 |
| 42027 | Cuchillo Lunch MB | 178 | 12 |
| 42008 | Cuchara Moka | 115 | 12 |
| 42012 | Pala Pescado | 200 | 12 |
| 42013 | Tenedor Pescado | 195 | 12 |

Hoterali@



Verdi

- ✓ 3 mm
- ✓ Pulido Espejo
- ✓ Inox 18/10



| Referencia | Descripción | ←→ mm | Box |
|------------|--------------------|-------|-----|
| 42601 | Cuchara Mesa | 203 | 12 |
| 42602 | Tenedor Mesa | 203 | 12 |
| 42603 | Cuchillo Mesa MB | 225 | 12 |
| 42633 | Cuchillo Chuletero | 225 | 12 |
| 42604 | Cuchara Postre | 186 | 12 |
| 42605 | Tenedor Postre | 186 | 12 |
| 42606 | Cuchillo Postre MB | 202 | 12 |
| 42607 | Cuchara Café | 150 | 12 |
| 42609 | Tenedor Lunch | 156 | 12 |
| 42608 | Cuchara Moka | 118 | 12 |
| 42612 | Pala Pescado | 204 | 12 |
| 42613 | Tenedor Pescado | 185 | 12 |

Hoterali@





City

- ✓ 3 mm
- ✓ Pulido Espejo
- ✓ Inox 18/10

| Referencia | Descripción | <—> mm | Box |
|------------|--------------------|--------|-----|
| 120001 | Cuchara Mesa | 210 | 12 |
| 120002 | Tenedor Mesa | 215 | 12 |
| 120003 | Cuchillo Mesa MB | 230 | 12 |
| 120004 | Cuchara Postre | 180 | 12 |
| 120005 | Tenedor Postre | 180 | 12 |
| 120006 | Cuchillo Postre MB | 200 | 12 |
| 120007 | Cuchara café | 135 | 12 |
| 120008 | Cuchara moka | 116 | 12 |
| 120012 | Tenedor Lunch | 155 | 12 |
| 120015 | Tenedor Pescado | 200 | 12 |
| 120016 | Pala Pescado | 207 | 12 |

Hoterali@



Daniela

- ✓ 3 mm
- ✓ Pulido Espejo
- ✓ Inox 18/10

| Referencia | Descripción | <—> mm | Box |
|------------|--------------------|--------|-----|
| 111001 | Cuchara Mesa | 202 | 12 |
| 111002 | Tenedor Mesa | 202 | 12 |
| 111003 | Cuchillo Mesa MB | 220 | 12 |
| 111004 | Cuchara Postre | 179 | 12 |
| 111005 | Tenedor Postre | 178 | 12 |
| 111006 | Cuchillo Postre MB | 192 | 12 |
| 111007 | Cuchara Café | 133 | 12 |
| 111012 | Tenedor Lunch | 153 | 12 |
| 111008 | Cuchara Moka | 116 | 12 |
| 111015 | Tenedor Pescado | 201 | 12 |
| 111016 | Pala Pescado | 207 | 12 |



Evento

- ✓ 4 mm
- ✓ Pulido Espejo
- ✓ Inox 18/10

| Referencia | Descripción | ←→ mm | Box |
|------------|--------------------|-------|-----|
| 1001201 | Cuchara Mesa | 203 | 12 |
| 1001202 | Tenedor Mesa | 201 | 12 |
| 1001203 | Cuchillo Mesa MB | 230 | 12 |
| 1001237 | Cuchillo Chuletero | 225 | 12 |
| 1001204 | Cuchara Postre | 171 | 12 |
| 1001205 | Tenedor Postre | 171 | 12 |
| 1001206 | Cuchillo Postre MB | 206 | 12 |
| 1001207 | Cuchara Café | 134 | 12 |
| 1001212 | Tenedor Lunch | 155 | 12 |
| 1001208 | Cucharita Moka | 117 | 12 |
| 1001216 | Pala Pescado | 204 | 12 |
| 1001215 | Tenedor Pescado | 202 | 12 |



comas
EVERYDAY CUTLERY

Hotel

- ✓ 1,5 mm
- ✓ Acabado vibrado
- ✓ Inox 18%

| Referencia | Descripción | ←→ mm | Box |
|------------|--------------------|-------|-----|
| 0014 | Cuchara Mesa | 195 | 12 |
| 0015 | Tenedor Mesa | 197 | 12 |
| 0013 | Cuchillo Mesa | 214 | 12 |
| 2454 | Cuchillo Chuletero | 225 | 12 |
| 0019 | Cuchara Postre | 186 | 12 |
| 0020 | Tenedor Postre | 178 | 12 |
| 0018 | Cuchillo Postre | 190 | 12 |
| 0023 | Cuchara Café | 140 | 12 |
| 0024 | Cuchara Moka | 110 | 12 |
| 0022 | Tenedor Lunch | 150 | 12 |
| 0021 | Cuchillo Lunch | 165 | 12 |



Mahé

- ✓ 5 mm
- ✓ Pulido Espejo
- ✓ Inox 18/10

| Referencia | Descripción | ←→ mm | Box |
|------------|--------------------------|-------|-----|
| 1810-1 | Tenedor Mesa | 214 | 12 |
| 1810-2 | Cuchara Mesa | 214 | 12 |
| 1810-5 | Cuchillo Mesa MB | 237 | 12 |
| 1810-5V | Cuchillo Mesa Vertical | 235 | 12 |
| 1810-15 | Cuchara Postre | 188 | 12 |
| 1810-14 | Tenedor Postre | 188 | 12 |
| 1810-6 | Cuchillo Postre MB | 215 | 12 |
| 1810-6V | Cuchillo Postre Vertical | 213 | 12 |
| 1810-3 | Cuchara Café | 140 | 12 |
| 1810-26 | Cuchara Moka | 110 | 12 |
| 1810-4 | Tenedor Lunch | 155 | 12 |
| 1810-40 | Cuchillo Mantequero | 172 | 12 |
| 1810-16 | Tenedor Pescado | 184 | 12 |
| 1810-17 | Pala Pescado | 204 | 12 |

eternum 
creatori 1924



X-15

- ✓ 10 mm
- ✓ Pulido Espejo
- ✓ Inox 18/10



| Referencia | Descripción | ←→ mm | Box |
|------------|---------------------|-------|-----|
| 1860-1 | Tenedor Mesa | 218 | 12 |
| 1860-2 | Cuchara Mesa | 215 | 12 |
| 1860-5 | Cuchillo Mesa MB | 242 | 12 |
| 1860-45 | Cuchillo Chuletero | 243 | 12 |
| 1860-15 | Cuchara Postre | 191 | 12 |
| 1860-14 | Tenedor Postre | 193 | 12 |
| 1860-6 | Cuchillo Postre MB | 216 | 12 |
| 1860-26 | Cuchara Café | 143 | 12 |
| 1860-26 | Cuchara Moka | 110 | 12 |
| 1860-4 | Tenedor Lunch | 144 | 12 |
| 1860-40 | Cuchillo Mantequero | 162 | 12 |
| 1860-16 | Tenedor Pescado | 192 | 12 |
| 1860-17 | Pala Pescado | 206 | 12 |

eternum
created 1924





London

- √ 2,5 mm
- √ Pulido Espejo
- √ Inox 18/10

| Referencia | Descripción | ←→ mm | Box |
|------------|--------------------|-------|-----|
| 4335 | Cuchara Mesa | 205 | 12 |
| 4336 | Tenedor Mesa | 205 | 12 |
| 4362 | Cuchillo Mesa | 240 | 12 |
| 5952 | Cuchillo Chuletero | 228 | 12 |
| 5374 | Cuchara Postre | 185 | 12 |
| 5375 | Tenedor Postre | 185 | 12 |
| 5012 | Cuchillo Postre | 217 | 12 |
| 5437 | Cuchara Café | 137 | 12 |
| 5439 | Tenedor Lunch | 145 | 12 |
| 5438 | Cuchara Moka | 115 | 12 |
| 5373 | Tenedor Pescado | 195 | 12 |
| 5372 | Pala Pescado | 200 | 12 |

comas
EVERYDAY CUTLERY

North

- √ 3 mm
- √ Pulido Espejo
- √ Inox 18/10



| Referencia | Descripción | ←→ mm | Box |
|------------|--------------------|-------|-----|
| 4536 | Cuchara Mesa | 205 | 12 |
| 4537 | Tenedor Mesa | 205 | 12 |
| 4535 | Cuchillo Mesa | 230 | 12 |
| 4402 | Cuchillo Chuletero | 228 | 12 |
| 5378 | Cuchara Postre | 185 | 12 |
| 5379 | Tenedor Postre | 185 | 12 |
| 4538 | Cuchillo Postre | 212 | 12 |
| 3948 | Cuchara Café | 135 | 12 |
| 5566 | Tenedor Lunch | 145 | 12 |
| 5015 | Cuchillo Lunch | 178 | 12 |
| 3949 | Cuchara Moka | 115 | 12 |
| 5377 | Tenedor Pescado | 195 | 12 |
| 5376 | Pala Pescado | 200 | 12 |



Mia

- √ 3 mm
- √ Pulido Espejo
- √ Inox 18/10

| Referencia | Descripción | ←→ mm | Box |
|------------|-----------------|-------|-----|
| 2710 | Cuchara Mesa | 207 | 12 |
| 2711 | Tenedor Mesa | 203 | 12 |
| 2774 | Cuchillo Mesa | 229 | 12 |
| 2712 | Cuchara Postre | 190 | 12 |
| 2713 | Tenedor Postre | 190 | 12 |
| 5826 | Cuchillo Postre | 200 | 12 |
| 2715 | Cuchara Café | 136 | 12 |
| 2714 | Tenedor Lunch | 136 | 12 |
| 2716 | Cuchara Moka | 109 | 12 |
| 2734 | Pala Pescado | 215 | 12 |

comas
EVERYDAY CUTLERY



Madrid

- √ 3 mm
- √ Pulido Espejo
- √ Inox 18%

| Referencia | Descripción | ←→ mm | Box |
|------------|--------------------|-------|-----|
| 1340 | Cuchara Mesa | 210 | 12 |
| 1341 | Tenedor Mesa | 205 | 12 |
| 2775 | Cuchillo Mesa | 221 | 12 |
| 1339 | Cuchillo Chuletero | 220 | 12 |
| 1595 | Cuchara Postre | 183 | 12 |
| 6117 | Tenedor Postre | 185 | 12 |
| 6115 | Cuchillo Postre | 204 | 12 |
| 1342 | Cuchara Café | 140 | 12 |
| 9655 | Tenedor Lunch | 140 | 12 |
| 9654 | Cuchara Moka | 110 | 12 |
| 9653 | Tenedor Pescado | 185 | 12 |
| 6114 | Pala Pescado | 200 | 12 |



Estasi

- ✓ 4 mm
- ✓ Pulido Espejo
- ✓ Inox 18/10

| Referencia | Descripción | ←→ mm | Box |
|------------|--------------------|-------|-----|
| 997801 | Cuchara Mesa | 208 | 12 |
| 997802 | Tenedor Mesa | 208 | 12 |
| 997803 | Cuchillo Mesa MB | 236 | 12 |
| 997804 | Cuchara Postre | 183 | 12 |
| 997805 | Tenedor Postre | 183 | 12 |
| 997806 | Cuchillo Postre MB | 205 | 12 |
| 997807 | Cuchara Café | 142 | 12 |
| 997812 | Tenedor Lunch | 144 | 12 |
| 997808 | Cucharita Moka | 112 | 12 |
| 997815 | Tenedor Pescado | 208 | 12 |
| 997816 | Pala Pescado | 193 | 12 |



Gold

| Referencia | Descripción | ←→ mm | Box |
|------------|--------------------|-------|-----|
| 0997801VO | Cuchara Mesa | 208 | 12 |
| 0997802VO | Tenedor Mesa | 208 | 12 |
| 0997803VO | Cuchillo Mesa MB | 236 | 12 |
| 0997804VO | Cuchara Postre | 183 | 12 |
| 0997805VO | Tenedor Postre | 183 | 12 |
| 0997806VO | Cuchillo Postre MB | 205 | 12 |
| 0997807VO | Cuchara Café | 142 | 12 |
| 0997812VO | Tenedor Lunch | 144 | 12 |
| 0997808VO | Cucharita Moka | 112 | 12 |
| 0997815VO | Tenedor Pescado | 208 | 12 |
| 0997816VO | Pala Pescado | 193 | 12 |



Black

| Referencia | Descripción | ←→ mm | Box |
|------------|--------------------|-------|-----|
| 0997801VN | Cuchara Mesa | 208 | 12 |
| 0997802VN | Tenedor Mesa | 208 | 12 |
| 0997803VN | Cuchillo Mesa MB | 236 | 12 |
| 0997804VN | Cuchara Postre | 183 | 12 |
| 0997805VN | Tenedor Postre | 183 | 12 |
| 0997806VN | Cuchillo Postre MB | 205 | 12 |
| 0997807VN | Cuchara Café | 142 | 12 |
| 0997812VN | Tenedor Lunch | 144 | 12 |
| 0997808VN | Cucharita Moka | 112 | 12 |
| 0997815VN | Tenedor Pescado | 208 | 12 |
| 0997816VN | Pala Pescado | 193 | 12 |



Bronze

| Referencia | Descripción | ←→ mm | Box |
|------------|--------------------|-------|-----|
| 0997801VR | Cuchara Mesa | 208 | 12 |
| 0997802VR | Tenedor Mesa | 208 | 12 |
| 0997803VR | Cuchillo Mesa MB | 236 | 12 |
| 0997804VR | Cuchara Postre | 183 | 12 |
| 0997805VR | Tenedor Postre | 183 | 12 |
| 0997806VR | Cuchillo Postre MB | 205 | 12 |
| 0997807VR | Cuchara Café | 142 | 12 |
| 0997812VR | Tenedor Lunch | 144 | 12 |
| 0997808VR | Cucharita Moka | 112 | 12 |
| 0997815VR | Tenedor Pescado | 208 | 12 |
| 0997816VR | Pala Pescado | 193 | 12 |



Baguette

- ✓ 3 mm
- ✓ Envejecido
- ✓ Inox 18/10



Vittoriale

- ✓ 3 mm
- ✓ Envejecido
- ✓ Inox 18/10



Settecento

- ✓ 3 mm
- ✓ Envejecido
- ✓ Inox 18/10

PINTINOX

Baguette

| Referencia | Descripción | ←→ mm | Box |
|------------|--------------------|-------|-----|
| 08320001 | Cuchara Mesa | 206 | 12 |
| 08320002 | Tenedor Mesa | 206 | 12 |
| 08320003 | Cuchillo Mesa MH | 241 | 12 |
| 08320004 | Cuchara Postre | 178 | 12 |
| 08320005 | Tenedor Postre | 185 | 12 |
| 08320006 | Cuchillo Postre MH | 220 | 12 |
| 08320007 | Cuchara Café | 146 | 12 |
| 08320008 | Cuchara Moka | 118 | 12 |
| 08320017 | Tenedor Lunch | 151 | 12 |

Vittoriale

| Referencia | Descripción | ←→ mm | Box |
|------------|--------------------|-------|-----|
| 16420001 | Cuchara Mesa | 209 | 12 |
| 16420002 | Tenedor Mesa | 209 | 12 |
| 16420003 | Cuchillo Mesa MH | 240 | 12 |
| 16420004 | Cuchara Postre | 188 | 12 |
| 16420005 | Tenedor Postre | 188 | 12 |
| 16420006 | Cuchillo Postre MH | 215 | 12 |
| 16420007 | Cuchara Café | 145 | 12 |
| 16420008 | Cuchara Moka | 120 | 12 |
| 16420017 | Tenedor Lunch | 159 | 12 |

Settecento

| Referencia | Descripción | ←→ mm | Box |
|------------|--------------------|-------|-----|
| 20540001 | Cuchara Mesa | 201 | 12 |
| 20540002 | Tenedor Mesa | 201 | 12 |
| 20540003 | Cuchillo Mesa MH | 227 | 12 |
| 20540004 | Cuchara Postre | 171 | 12 |
| 20540005 | Tenedor Postre | 171 | 12 |
| 20540006 | Cuchillo Postre MH | 202 | 12 |
| 20540007 | Cuchara Café | 146 | 12 |
| 20540008 | Cuchara Moka | 118 | 12 |
| 20540017 | Tenedor Lunch | 148 | 12 |



Danubio

- ✓ 2,5 mm
- ✓ Pulido Espejo
- ✓ Inox 18/10

| Referencia | Descripción | ←→ mm | Box |
|------------|--------------------|-------|-----|
| 5000010 | Cuchara Mesa | 208 | 12 |
| 5000020 | Tenedor Mesa | 208 | 12 |
| 5000035 | Cuchillo Mesa MB | 220 | 12 |
| 5000040 | Cuchara Postre | 193 | 12 |
| 5000050 | Tenedor Postre | 191 | 12 |
| 5000095 | Cuchillo Postre MB | 186 | 12 |
| 5000100 | Cuchara Café | 150 | 12 |
| 5000070 | Cuchara Moka | 122 | 12 |
| 5000800 | Tenedor Lunch | 155 | 12 |
| 5000130 | Tenedor Pescado | 193 | 12 |
| 5000120 | Pala Pescado | 217 | 12 |



Lidia

- ✓ 2 mm
- ✓ Pulido Espejo
- ✓ Inox 18/10



| Referencia | Descripción | ←→ mm | Box |
|------------|-------------------|-------|-----|
| 6100010 | Cuchara Mesa | 202 | 12 |
| 6100020 | Tenedor Mesa | 200 | 12 |
| 6100030 | Cuchillo Mesa MB | 211 | 12 |
| 6100100 | Cuchara Café | 145 | 12 |
| 6100620 | Cuchara Moka | 107 | 12 |
| 6100625 | Tenedor Lunch | 145 | 12 |
| 6100035 | Cuchillo Lunch MB | 174 | 12 |



Iris

√ 3,5 mm

√ Pulido Espejo

√ Inox 18/10

| Referencia | Descripción | <—> mm | Box |
|------------|-----------------------|--------|-----|
| 9400010 | Cuchara Mesa | 217 | 12 |
| 9400020 | Tenedor Mesa | 216 | 12 |
| 9400035 | Cuchillo Mesa MB | 230 | 12 |
| 9400625 | Cuchillo Chuletero MB | 228 | 12 |
| 9400040 | Cuchara Postre | 186 | 12 |
| 9400050 | Tenedor Postre | 188 | 12 |
| 9400095 | Cuchillo Postre MB | 187 | 12 |
| 9400100 | Cuchara Café | 151 | 12 |
| 9400070 | Cuchara Moka | 131 | 12 |
| 9400080 | Tenedor Lunch | 153 | 12 |
| 9400130 | Tenedor Pescado | 188 | 12 |
| 9400120 | Pala Pescado | 199 | 12 |



Royal

√ 2,5 mm

√ Pulido Espejo

√ Inox 18/10

| Referencia | Descripción | <—> mm | Box |
|------------|--------------------|--------|-----|
| 1725010 | Cuchara Mesa | 199 | 12 |
| 1725020 | Tenedor Mesa | 195 | 12 |
| 1725035 | Cuchillo Mesa MB | 206 | 12 |
| 1725040 | Cuchara Postre | 188 | 12 |
| 1725050 | Tenedor Postre | 182 | 12 |
| 1725095 | Cuchillo Postre MB | 172 | 12 |
| 1725100 | Cuchara Café | 142 | 12 |
| 1725070 | Cuchara Moka | 118 | 12 |
| 1725080 | Tenedor Lunch | 147 | 12 |
| 1725130 | Tenedor Pescado | 193 | 12 |
| 1725120 | Pala Pescado | 210 | 12 |



Laura

- √ 2,5 mm
- √ Pulido Espejo
- √ Inox 18/10

| Referencia | Descripción | <—> mm | Box |
|------------|-----------------------|--------|-----|
| 9600010 | Cuchara Mesa | 214 | 12 |
| 9600020 | Tenedor Mesa | 208 | 12 |
| 9600035 | Cuchillo Mesa MB | 214 | 12 |
| 9600625 | Cuchillo Chuletero MB | 218 | 12 |
| 9600040 | Cuchara Postre | 190 | 12 |
| 9600050 | Tenedor Postre | 188 | 12 |
| 9600095 | Cuchillo Postre MB | 185 | 12 |
| 9600100 | Cuchara Café | 156 | 12 |
| 9600070 | Cuchara Moka | 121 | 12 |
| 9600080 | Tenedor Lunch | 153 | 12 |
| 9600130 | Tenedor Pescado | 190 | 12 |
| 9600120 | Pala Pescado | 212 | 12 |



Teresa

- √ 2,5 mm
- √ Pulido Espejo
- √ Inox 18/10

| Referencia | Descripción | <—> mm | Box |
|------------|-----------------------|--------|-----|
| 8100010 | Cuchara Mesa | 198 | 12 |
| 8100020 | Tenedor Mesa | 200 | 12 |
| 8100035 | Cuchillo Mesa MB | 215 | 12 |
| 8100625 | Cuchillo Chuletero MB | 221 | 12 |
| 8100040 | Cuchara Postre | 175 | 12 |
| 8100050 | Tenedor Postre | 174 | 12 |
| 8100095 | Cuchillo Postre MB | 185 | 12 |
| 8100100 | Cuchara Café | 145 | 12 |
| 8100070 | Cuchara Moka | 109 | 12 |
| 8100080 | Tenedor Lunch | 145 | 12 |
| 8100130 | Tenedor Pescado | 175 | 12 |
| 8100120 | Pala Pescado | 198 | 12 |

Aranjuez

√ 3 mm
√ Pulido Espejo
√ Inox 18/10



| Referencia | Descripción | <—> mm | Box |
|------------|-----------------|--------|-----|
| 163010 | Cuchara Mesa | 207 | 12 |
| 163020 | Tenedor Mesa | 204 | 12 |
| 163030 | Cuchillo Mesa | 245 | 12 |
| 163040 | Cuchara Postre | 172 | 12 |
| 163050 | Tenedor Postre | 171 | 12 |
| 163060 | Cuchillo Postre | 196 | 12 |
| 163100 | Cuchara Café | 135 | 12 |
| 163070 | Cuchara Moka | 101 | 12 |
| 163080 | Tenedor Lunch | 135 | 12 |
| 163090 | Cuchillo Lunch | 178 | 12 |
| 163130 | Tenedor Pescado | 181 | 12 |
| 163120 | Pala Pescado | 198 | 12 |



Inglete

√ 3 mm
√ Pulido Espejo
√ Inox 18/10



| Referencia | Descripción | <—> mm | Box |
|------------|-----------------|--------|-----|
| 107010 | Cuchara Mesa | 213 | 12 |
| 107020 | Tenedor Mesa | 217 | 12 |
| 107030 | Cuchillo Mesa | 252 | 12 |
| 107040 | Cuchara Postre | 179 | 12 |
| 107050 | Tenedor Postre | 182 | 12 |
| 107060 | Cuchillo Postre | 210 | 12 |
| 107100 | Cuchara Café | 142 | 12 |
| 107070 | Cuchara Moka | 94 | 12 |
| 107080 | Tenedor Lunch | 144 | 12 |
| 107090 | Cuchillo Lunch | 185 | 12 |
| 107130 | Tenedor Pescado | 178 | 12 |
| 107120 | Pala Pescado | 211 | 12 |



Olivia

- √ 3 mm
- √ Pulido Espejo
- √ Inox 18/10

| Referencia | Descripción | <—> mm | Box |
|------------|--------------------|--------|-----|
| 49001 | Cuchara Mesa | 230 | 12 |
| 49002 | Tenedor Mesa | 230 | 12 |
| 49003 | Cuchillo Mesa MB | 245 | 12 |
| 49004 | Cuchara Postre | 198 | 12 |
| 49005 | Tenedor Postre | 197 | 12 |
| 49006 | Cuchillo Postre MB | 214 | 12 |
| 49007 | Cuchara Café | 165 | 12 |
| 49017 | Tenedor Lunch | 197 | 12 |
| 49008 | Cucharita Moka | 110 | 12 |
| 49028 | Tenedor Pescado | 197 | 12 |
| 49029 | Pala Pescado | 218 | 12 |

PINTINOX



Ellade

- √ 3 mm
- √ Pulido Espejo
- √ Inox 18/10

| Referencia | Descripción | <—> mm | Box |
|------------|--------------------|--------|-----|
| 79001 | Cuchara Mesa | 212 | 12 |
| 79002 | Tenedor Mesa | 211 | 12 |
| 79003 | Cuchillo Mesa MB | 240 | 12 |
| 79004 | Cuchara Postre | 187 | 12 |
| 79005 | Tenedor Postre | 184 | 12 |
| 79006 | Cuchillo Postre MB | 217 | 12 |
| 79007 | Cuchara Café | 155 | 12 |
| 79017 | Tenedor Lunch | 164 | 12 |
| 79008 | Cucharita Moka | 125 | 12 |
| 79028 | Tenedor Pescado | 186 | 12 |
| 79029 | Pala Pescado | 206 | 12 |



Wave

- ✓ 3 mm
- ✓ Pulido Espejo
- ✓ Inox 18%

| Referencia | Descripción | <—> mm | Box |
|------------|-----------------|--------|-----|
| 2610001 | Cuchara Mesa | 210 | 12 |
| 2610002 | Tenedor Mesa | 210 | 12 |
| 2610003 | Cuchillo Mesa | 226 | 12 |
| 2610005 | Tenedor Postre | 185 | 12 |
| 2610006 | Cuchillo Postre | 203 | 12 |
| 2610007 | Cuchara Café | 147 | 12 |
| 2610008 | Cucharita Moka | 110 | 12 |



Swing

- ✓ 3 mm
- ✓ Pulido Espejo
- ✓ Inox 18/10

| Referencia | Descripción | <—> mm | Box |
|------------|-----------------|--------|-----|
| 880001 | Cuchara Mesa | 208 | 12 |
| 880002 | Tenedor Mesa | 209 | 12 |
| 880003 | Cuchillo Mesa | 225 | 12 |
| 880004 | Cuchara Postre | 187 | 12 |
| 880005 | Tenedor Postre | 187 | 12 |
| 880006 | Cuchillo Postre | 205 | 12 |
| 880007 | Cuchara Café | 146 | 12 |
| 880017 | Tenedor Lunch | 154 | 12 |
| 880008 | Cucharita Moka | 118 | 12 |
| 880028 | Tenedor Pescado | 181 | 12 |
| 880029 | Pala Pescado | 198 | 12 |



Sonate

- ✓ 5 mm
- ✓ Pulido Espejo
- ✓ Inox 18/10

| Referencia | Descripción | <—> mm | Box |
|------------|--------------------|--------|-----|
| 977-1 | Tenedor Mesa | 199 | 12 |
| 977-2 | Cuchara Mesa | 198 | 12 |
| 977-5 | Cuchillo Mesa | 219 | 12 |
| 977-45 | Cuchillo Chuletero | 228 | 12 |
| 977-15 | Cuchara Postre | 175 | 12 |
| 977-14 | Tenedor Postre | 181 | 12 |
| 977-6 | Cuchillo Postre | 191 | 12 |
| 977-3 | Cuchara Café | 143 | 12 |
| 977-26 | Cuchara Moka | 114 | 12 |
| 977-4 | Tenedor Lunch | 149 | 12 |
| 977-16 | Tenedor Pescado | 180 | 12 |
| 977-17 | Pala Pescado | 206 | 12 |

eternum 
creadori 1924



Rustic

- ✓ Forjado
- ✓ Pulido Espejo
- ✓ Inox 18/10



| Referencia | Descripción | ←→ mm | Box |
|------------|--------------------|-------|-----|
| 8005-1 | Tenedor Mesa | 199 | 12 |
| 8005-2 | Cuchara Mesa | 198 | 12 |
| 8005-5 | Cuchillo Mesa | 225 | 12 |
| 8005-45 | Cuchillo Chuletero | 225 | 12 |
| 8005-3 | Cuchara Café | 142 | 12 |
| 8005-26 | Cuchara Moka | 112 | 12 |
| 8005-4 | Tenedor Lunch | 150 | 12 |

eternum 
created 1924





Pétale

- ✓ 5,5 mm
- ✓ Pulido Espejo
- ✓ Inox 18/10

| Referencia | Descripción | <—> mm | Box |
|------------|-----------------|--------|-----|
| 1880-1 | Tenedor Mesa | 215 | 12 |
| 1880-2 | Cuchara Mesa | 215 | 12 |
| 1880-5 | Cuchillo Mesa | 240 | 12 |
| 1880-15 | Cuchara Postre | 190 | 12 |
| 1880-14 | Tenedor Postre | 190 | 12 |
| 1880-6 | Cuchillo Postre | 215 | 12 |
| 1880-3 | Cuchara Café | 145 | 12 |
| 1880-26 | Cuchara Moka | 110 | 12 |
| 1880-4 | Tenedor Lunch | 145 | 12 |
| 1880-16 | Tenedor Pescado | 190 | 12 |
| 1880-17 | Pala Pescado | 210 | 12 |

eternum 
created 1924



Iris

- ✓ 3 mm
- ✓ Pulido Espejo
- ✓ Inox 18/10



| Referencia | Descripción | ←→ mm | Box |
|------------|-----------------------|-------|-----|
| 11090001 | Cuchara Mesa | 214 | 12 |
| 11090002 | Tenedor Mesa | 213 | 12 |
| 11090003 | Cuchillo Mesa | 226 | 12 |
| 11090004 | Cuchara Postre | 189 | 12 |
| 11090005 | Tenedor Postre | 188 | 12 |
| 11090007 | Cuchara Café | 150 | 12 |
| 11090008 | Tenedor Lunch | 162 | 12 |
| 11090009 | Cuchillo Lunch/Postre | 197 | 12 |
| 11090010 | Pala Pescado | 207 | 12 |
| 11090011 | Tenedor Pescado | 188 | 12 |
| 11090012 | Cuchara Moka | 118 | 12 |
| 11090043 | Cuchillo Carne | 226 | 12 |



Ébano

- ✓ 3 mm
- ✓ Pulido Espejo
- ✓ Inox 18/10



| Referencia | Descripción | ←→ mm | Box |
|------------|------------------|-------|-----|
| 11086001 | Cuchara Mesa | 204 | 12 |
| 11086002 | Tenedor Mesa | 205 | 12 |
| 11086003 | Cuchillo Mesa | 229 | 12 |
| 11086004 | Cuchara Postre | 185 | 12 |
| 11086005 | Tenedor Postre | 185 | 12 |
| 11086006 | Cuchillo Postre | 202 | 12 |
| 11086007 | Cuchara Café | 149 | 12 |
| 11086008 | Tenedor Lunch | 153 | 12 |
| 11086009 | Cuchillo Lunch | 188 | 12 |
| 11086010 | Pala Pescado | 205 | 12 |
| 11086011 | Tenedor Pescado | 185 | 12 |
| 11086012 | Cuchara Moka | 117 | 12 |
| 11086030 | Pala mantequilla | 170 | 12 |



Vanity

✓ 2 mm

✓ Pulido Espejo

✓ Inox

| Referencia | Descripción | <—> mm | Box |
|------------|-----------------------|--------|-----|
| 11049001 | Cuchara Mesa | 207 | 12 |
| 11049002 | Tenedor Mesa | 206 | 12 |
| 11049003 | Cuchillo Mesa | 222 | 12 |
| 11049004 | Cuchara Postre | 184 | 12 |
| 11049005 | Tenedor Postre | 184 | 12 |
| 11049007 | Cuchara Café | 145 | 12 |
| 11049008 | Tenedor Lunch | 160 | 12 |
| 11049009 | Cuchillo Lunch/Postre | 195 | 12 |
| 11049010 | Pala Pescado | 204 | 12 |
| 11049011 | Tenedor Pescado | 184 | 12 |
| 11049012 | Cuchara Moka | 117 | 12 |



Silk

✓ 2 mm

✓ Pulido Espejo

✓ Inox



| Referencia | Descripción | <—> mm | Box |
|------------|-----------------|--------|-----|
| 12068001 | Cuchara Mesa | 203 | 12 |
| 12068002 | Tenedor Mesa | 201 | 12 |
| 12068003 | Cuchillo Mesa | 215 | 12 |
| 12068004 | Cuchara Postre | 185 | 12 |
| 12068005 | Tenedor Postre | 183 | 12 |
| 12068006 | Cuchillo Postre | 202 | 12 |
| 12068007 | Cuchara Café | 143 | 12 |
| 12068008 | Tenedor Lunch | 148 | 12 |
| 12068009 | Cuchillo Lunch | 182 | 12 |
| 12068010 | Pala Pescado | 203 | 12 |
| 12068011 | Tenedor Pescado | 183 | 12 |
| 12068012 | Cuchara Moka | 115 | 12 |
| 12068043 | Cuchillo Carne | 222 | 12 |

Chuleteros



| Referencia | Descripción |
|------------|-----------------------------|
| 371500 | Cuchillo Chuletero M/Madera |
| 371600 | Tenedor Chuletero M/Madera |



| Referencia | Descripción |
|------------|--------------------------------|
| 375500 | Cuchillo Chuletero Inox Sierra |
| 376500 | Cuchillo Chuletero Inox Filo |
| 7021400 | Tenedor Chuletero Inox |



| Referencia | Descripción |
|------------|---------------------------------|
| 375000 | Cuchillo Chuletero Virola Latón |
| 375100 | Tenedor Chuletero Virola Latón |



| Referencia | Descripción |
|------------|-----------------------------|
| 372500 | Cuchillo Chuletero M/Madera |
| 372600 | Tenedor Chuletero M/Madera |



| Referencia | Descripción |
|------------|--------------------------------|
| 372800 | Cuchillo Chuletero M/PP Sierra |
| 372600 | Tenedor Chuletero M/PP Filo |



| Referencia | Descripción |
|------------|----------------------------------|
| 0681 | Cuchillo Chuletero Inox Satinado |
| 42633 | Cuchillo Chuletero Inox Verdi |



| Referencia | Descripción |
|------------|---------------------------------|
| 373700 | Cuchillo Chuletero M/Palisandro |
| 373723 | Cuchillo Chuletero M/Resina |
| 373728 | Cuchillo Chuletero M/Resina |



| Referencia | Descripción |
|------------|---------------------------|
| 076000Y | Cuchillo Chuletero Sierra |



| Referencia | Descripción |
|------------|----------------------------|
| 374610 | Cuchillo Chuletero Macheta |
| 374210 | Tenedor Chuletero Macheta |



| Referencia | Descripción |
|------------|-------------------------|
| 3000 | Cuchillo Chuletero Alps |



| Referencia | Descripción |
|------------|-------------------------------|
| 3136 | Cuchillo Chuletero K2 Natural |
| 3137 | Cuchillo Chuletero K2 Negro |



| Referencia | Descripción |
|------------|---------------------------|
| 741000EU | Cuchillo Chuletero Sierra |
| 741000EY | Tenedor Chuletero Filo |



| Referencia | Descripción |
|------------|-----------------------------------|
| 374822 | Cuchillo Chuletero M/POM Rojo |
| 374722 | Tenedor Chuletero M/POM Rojo |
| 374823 | Cuchillo Chuletero M/POM Azul |
| 374723 | Tenedor Chuletero M/POM Azul |
| 374821 | Cuchillo Chuletero M/POM Verde |
| 374721 | Tenedor Chuletero M/POM Verde |
| 374825 | Cuchillo Chuletero M/POM Amarillo |
| 374725 | Tenedor Chuletero M/POM Amarillo |

CUCHILLERÍA

Knives • Couteaux • Coltelli • Messer



Clásica

HOJA: Acero inoxidable Forjado NITRUM®.
MANGO: Polioximetileno (POM).

ARCOS

| Referencia | Descripción | <—> mm |
|------------|-------------|--------|
| 1 255300 | Cocinero | 260 |
| 2 255200 | Cocinero | 230 |
| 3 255100 | Cocinero | 210 |
| 4 255500 | Cocinero | 160 |
| 5 256800 | Jamoner | 300 |
| 6 256700 | Jamoner | 250 |
| 7 256000 | Filetear | 210 |
| 8 255900 | Filetear | 160 |
| 9 256600 | Santoku | 180 |
| 10 256900 | Santoku | 140 |
| 11 256500 | Deshuesar | 160 |
| 12 256200 | Deshuesar | 140 |
| 13 256400 | Pan | 180 |
| 14 256300 | Tenedor | 160 |
| 15 255600 | Tomatero | 130 |
| 16 255800 | Chuletero | 120 |
| 17 255700 | Puntilla | 100 |



Kyoto

HOJA: Acero inoxidable Forjado NITRUM®.
MANGO: Polioximetileno (POM).

ARCOS

| Referencia | Descripción | ←→ mm |
|------------|---------------|-------|
| 1 178400 | Cocinero | 240 |
| 2 178300 | Cocinero | 210 |
| 3 178600 | Jamonero | 250 |
| 4 178800 | Santoku | 185 |
| 5 178500 | Deshuesar | 145 |
| 6 178700 | Pan | 220 |
| 7 179000 | Cocina Sierra | 160 |
| 8 178900 | Cocina | 160 |
| 9 178200 | Verduras | 125 |
| 10 178000 | Mondador | 100 |



Riviera

HOJA: Acero inoxidable Forjado NITRUM®.
MANGO: Polioximetileno (POM).

ARCOS

Referencia Descripción <—> mm

| | | | |
|----|--------|-----------|-----|
| 1 | 233800 | Cocinero | 300 |
| | 233700 | Cocinero | 250 |
| | 233600 | Cocinero | 200 |
| | 233400 | Cocinero | 150 |
| 2 | 231100 | Jamonero | 300 |
| 3 | 231000 | Jamonero | 250 |
| 4 | 233000 | Filetear | 200 |
| | 232900 | Filetear | 170 |
| 5 | 233500 | Santoku | 180 |
| | 233200 | Santoku | 140 |
| 6 | 231500 | Deshuesar | 130 |
| 7 | 231300 | Pan | 200 |
| 8 | 233300 | Tenedor | 180 |
| 9 | 232800 | Queso | 145 |
| 10 | 232000 | Tomatero | 130 |
| 11 | 230600 | Cocinero | 150 |
| | 230500 | Cocinero | 130 |
| 12 | 230200 | Mondador | 100 |



Tango

HOJA: Acero inoxidable Forjado NITRUM®.
MANGO: Polipropileno.

ARCOS

| Referencia | Descripción | ←→ mm |
|------------|-------------|-------|
| 1 | Cocinero | 200 |
| 2 | Jamonero | 240 |
| 3 | Filetear | 170 |
| 4 | Santoku | 180 |
| 5 | Pan | 200 |
| 6 | Cocinero | 160 |
| 7 | Verduras | 120 |
| 8 | Mondador | 100 |



Universal

HOJA: Acero inoxidable Forjado NITRUM®.
MANGO: Polioximetileno (POM).

ARCOS

Referencia Descripción <—> mm

| | | | |
|----|--------|--------------------|---------|
| | 280804 | Cocinero | 300 |
| | 280704 | Cocinero | 250 |
| 1 | 280604 | Cocinero | 200 |
| | 280504 | Cocinero | 175 |
| | 280804 | Cocinero | 155 |
| | 283304 | Carnicero | 300 |
| 2 | 283204 | Carnicero | 250 |
| | 283104 | Carnicero | 200 |
| 3 | 282604 | Deshuesar | 160 |
| | 282504 | Deshuesar | 130 |
| 4 | 282204 | Panero | 250 |
| | 282104 | Panero | 200 |
| 5 | 284304 | Pastelero | 300 |
| 6 | 283904 | Pastelero | 250 |
| 7 | 281604 | Queso | 145 |
| 8 | 280304 | Puntilla | 120 |
| | 280204 | Puntilla | 100 |
| 9 | 282004 | Jamón P/redonda | 290 |
| 10 | 284004 | Salmón P/redonda | 290 |
| 11 | 283804 | Jamón Ancho | 300 |
| 12 | 283704 | Salmón Ancho | 300 |
| 13 | 281904 | Jamón Punta | 280 |
| | 281804 | Jamón Punta | 240 |
| 14 | 281901 | Salmón Punta | 280 |
| | 281801 | Salmón Punta | 240 |
| 15 | 286400 | Espátula | 125x90 |
| 16 | 286500 | Espátula | 125x120 |
| 17 | 286600 | Espátula Codo | 160 |
| | 286304 | Espátula Pastelero | 300 |
| 18 | 286204 | Espátula Pastelero | 250 |
| | 286104 | Espátula Pastelero | 205 |



Universal

HOJA: Acero inoxidable Forjado NITRUM®.
MANGO: Polioximetileno (POM).

ARCOS

| Referencia | Descripción | <—> mm |
|------------|--------------------|--------|
| 1 | Macheta | 180 |
| 2 | Macheta | 160 |
| 3 | Macheta | 280 |
| 4 | Macheta | 220 |
| 5 | Cuchilla Filetear | 280 |
| 6 | Cuchilla Filetear | 260 |
| 7 | Cuchillo Carnicero | 300 |
| 8 | Cuchillo Carnicero | 275 |
| 9 | Pescadero Redondo | 300 |
| 10 | Pescadero Punta | 320 |
| 11 | Pescadero Punta | 290 |
| 12 | Queso 2 Mangos | 400 |



2900

HOJA: Acero inoxidable Forjado NITRUM®.
MANGO: Inyectado Polipropileno.

Gracias al color del mango del cuchillo podemos saber para qué tipo de alimento se va a utilizar, permitiendo así un control higiénico-sanitario exhaustivo y el cumplimiento de las normas europeas sanitarias de control de la alimentación.



ALIMENTOS COCINADOS

VERDURAS Y FRUTAS

CARNE

PESCADO

PASTELERÍA Y LÁCTEOS

MULTIUSOS

LEGUMBRES Y VERDURAS

| Referencia | Descripción | ←→ mm | 00 | 21 | 22 | 23 | 24 | 25 | 28 | 31 |
|------------|--------------------|---------|----|----|----|----|----|----|----|----|
| 2923 | Cocinero | 300 | x | x | x | x | | x | | |
| 1 2922 | Cocinero | 250 | x | x | x | x | x | x | x | |
| 2921 | Cocinero | 200 | x | x | x | x | x | x | x | x |
| 2 2904 | Puntilla | 130 | x | x | x | x | | x | | x |
| 2938 | Jamonero | 400 | x | | x | | | x | | |
| 3 2935 | Jamonero | 350 | x | | x | | | x | | |
| 2934 | Jamonero | 300 | x | | x | | x | x | | |
| 2988 | Fiambre | 410 | x | | | | | x | | |
| 4 2987 | Fiambre | 360 | x | | | | | x | | |
| 2957 | Fiambre | 300 | x | | | | | x | | |
| 5 2914 | Pan | 200 | x | | | | x | x | | x |
| 6 2997 | Espátula | 125x120 | x | | | | | x | | |
| 2996 | Espátula | 125x90 | x | | | | | x | | |
| 2992 | Espátula Pastelero | 300 | x | | | | x | x | | |
| 7 2991 | Espátula Pastelero | 250 | x | | | | x | x | | x |
| 2990 | Espátula Pastelero | 200 | x | | | | x | x | | |



NUEVO COLOR ALÉRGENOS
Propuesta color fucsia para facilitar la identificación de los cuchillos a utilizar en las preparaciones para personas con algún tipo de alergia.



| Referencia | Descripción | <—> mm | 00 | 22 | 23 | 25 |
|------------|--------------------|--------|----|----|----|----|
| 2964 | Macheta | 270 | x | x | | x |
| 1 2963 | Macheta | 250 | x | x | | x |
| 2962 | Macheta | 220 | x | x | | x |
| 2983 | Cuchilla 3 mm | 280 | x | x | | x |
| 2 2981 | Cuchilla 3 mm | 260 | x | x | | x |
| 2982 | Cuchilla 2 mm | 280 | x | x | | x |
| 2980 | Cuchilla 2 mm | 260 | x | x | x | x |
| 3 2924 | Carnicero | 350 | x | x | x | x |
| 4 2925 | Pescadero | 350 | x | x | x | x |
| 2971 | Cuchilla Pescadero | 320 | x | | x | x |
| 5 2970 | Cuchilla Pescadero | 290 | x | | x | x |
| 6 2969 | Carnicero | 300 | x | x | | x |
| 7 2968 | Pollero | 275 | x | | | x |
| 8 2979 | Golpe | 255 | x | | | x |



Global

Los cuchillos GLOBAL están hechos con el más fino acero inoxidable. A la hora de confeccionar las hojas se utiliza el CROMOVA 18, siendo 18% el porcentaje de Cromo que hay en el acero. Este hecho le da una dureza suficiente al acero para que el cuchillo permanezca más tiempo afilado que la competencia, pero a su vez ésta no es excesiva para que no sea muy difícil de afilar.

El filo es de forma cóncava y no en forma de "V", ya que de esta forma se consigue que dure más tiempo afilado y también que el cuchillo se deslice mejor a través del alimento. Es importante resaltar que el afilado del cuchillo GLOBAL es artesanal.

Los cuchillos GLOBAL están templados al hielo y endurecidos con el proceso, "Rockwell", que somete la hoja a una temperatura de 56°C-58°C, lo que dota a los cuchillos de un filo cortante de más duración que el filo hecho con cualquier otro acero. Lo hace muy resistente a la herrumbre, a todo tipo de manchas y, en especial, a la corrosión.



| Referencia | Descripción | <—> mm |
|------------|---------------------|--------|
| G17 | Cocinero | 270 |
| 1 G16 | Cocinero | 240 |
| G2 | Cocinero | 200 |
| G19 | Filetear flexible | 270 |
| 2 G18 | Filetear flexible | 240 |
| G20 | Filetear flexible | 210 |
| 3 G5 | Vegetales | 180 |
| G56 | Vegetales alveolado | 180 |
| 4 G46 | Santoku | 180 |
| G48 | Santoku alveolado | 180 |
| 5 G09 | Pan | 220 |
| 6 G10 | Jamonero flexible | 310 |
| 7 G14 | Yanagi sashimi | 300 |
| G11 | Yanagi sashimi | 250 |
| 8 G7 | Deba | 180 |
| 9 G15 | Tako sashimi | 300 |
| GS2110 | Espatula | 250 |
| 10 GS2108 | Espatula | 200 |
| GS2106 | Espatula | 150 |
| GS2104 | Espatula | 110 |
| 11 GS38 | Puntilla | 90 |



Classic

PEtec: ¡La nueva tecnología de WÜSTHOF para una agudeza superior!

Tecnología:

- El láser mide las hojas antes del afilado.
- Los ordenadores calculan de forma individual para cada hoja el ángulo de afilado exacto.
- Unos robots de precisión afilan las hojas en una piedra húmeda.
- Finalmente, los cuchillos reciben la pasada definitiva de pulido mediante una muela especial.

Ventajas:

- Capacidad de corte inicial extrema.
- Duración del filo extraordinariamente larga.
- Geometría del filo óptima en toda la longitud de la hoja.
- Calidad incomparable, reproducible y siempre del mismo nivel.



| Referencia | Descripción | <—> mm |
|------------|---------------------|--------|
| 1522087 | Chef hoja ancha | 360 |
| 1522086 | Chef hoja ancha | 320 |
| 1522082 | Chef hoja ancha | 260 |
| 1522080 | Chef hoja ancha | 200 |
| 1522078 | Chef | 320 |
| 1522075 | Chef | 260 |
| 1522074 | Chef | 230 |
| 1522073 | Chef | 200 |
| 0505105 | Cocinero flexible | 200 |
| 152035 | Cocinero flexible | 160 |
| 0542010 | Jamonero largo | 320 |
| 0509100 | Jamonero P. redonda | 260 |
| 1575067 | Santoku | 170 |
| 1575063 | Santoku | 140 |
| 1522027 | Cuchillo trinchar | 200 |
| 16580320 | Tenedor trinchar | 200 |
| 1522024 | Puntilla | 120 |
| 1522022 | Puntilla | 100 |
| 1522020 | Puntilla | 90 |



Shun Damasco

Los productos Kai tienen desde hace tiempo prestigio y culto en Japón, junto con un alto grado de reconocimiento internacional. Grandes chefs de los cinco continentes utilizan sus cuchillos, junto a los buenos aficionados a la cocina.

Fundada en Seki en 1908, la compañía lleva más de 100 años fabricando cuchillos de las más altas gamas, con la serie Shun en acero damasco, como protagonista.



| Referencia | Descripción | <—> mm |
|------------|--------------------|--------|
| 1577207 | Chef | 250 |
| 1577205 | Chef | 200 |
| 1577203 | Chef | 150 |
| 1577201 | Chef | 105 |
| 1577104 | Chef hoja estrecha | 225 |
| 1577102 | Chef hoja estrecha | 180 |
| 1577195 | Jamonero | 300 |
| 1577661 | Santoku | 180 |
| 1577190 | Cuchillo trinchar | 200 |
| 1580025 | Tenedor trinchar | 200 |
| 1577000 | Puntilla | 85 |



Gen Series

La cerámica se encuentra cada vez más a menudo entre los utensilios de nuestra cocina. En el caso de los cuchillos, ha demostrado tener beneficios: Un filo inalterable, impermeabilidad a los colores, oxidaciones y una mejor higiene.

La cerámica es un material resistente que mantiene su capacidad de corte hasta diez veces más que el acero. Además, los cuchillos Kyocera no transfieren su sabor u olor a los alimentos, no se oxidan con los ácidos de las frutas y vegetales y evitan que estos se pongan negros al manipularlos.

Sin embargo, la dureza implica fragilidad. Es fundamental evitar los golpes contra superficies duras. Deben usarse sobre tablas de madera o de plástico y jamás para cortar huesos, espinas o alimentos congelados.



| Referencia | Descripción | <—> mm |
|------------|--------------------|--------|
| 2681122 | Chef blanco | 200 |
| 1 2681124 | Chef blanco | 180 |
| 2681123 | Chef blanco | 160 |
| 2681122 | Chef blanco | 140 |
| 2 2681120 | Usos varios blanco | 110 |
| 3 2681109 | Puntilla blanco | 75 |
| 2681018 | Chef negro | 180 |
| 4 2681019 | Chef negro | 160 |
| 2681018 | Chef negro | 140 |
| 5 2681014 | Usos varios negro | 110 |
| 6 2681008 | Puntilla negro | 75 |



Tijeras



Multiuso
Cód. 400 - Tijera 8"
Cód. 401 - Tijera 8" Azul



Master
Cód. 410 - Tijera Pulida 8"



Suprema
Cód. 416 - Tijera Pulida 9"



Profesional
Cód. 425 - Tijera Pulida 8"
Cód. 426 - Tijera Pulida 9"



Pescadero
Cód. 441 - Tijera Pulida 9,5"



Tijera Aves
Cód. 435 - 9,5"



Masticador
Cód. 432 - 7"

Soportes magnéticos



| Código | (mm) |
|--------|--------|
| 692700 | 500x45 |
| 692600 | 450x45 |
| 692500 | 300x45 |

Bolsas



Fundas protectoras

| Código | (mm) |
|--------|--------|
| 694000 | 80x22 |
| 694100 | 130x22 |
| 694200 | 200x32 |
| 694300 | 205x50 |
| 694400 | 265x50 |
| 694500 | 310x33 |

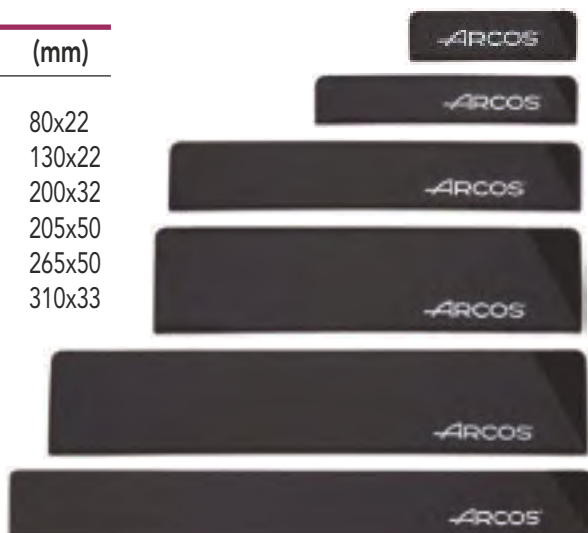

| Código | (mm) | Capacidad |
|--------|---------|-----------|
| 690200 | 460x275 | 4 Piezas |
| 690400 | 500x510 | 8 Piezas |
| 690500 | 730x510 | 12 Piezas |
| 691400 | 520x920 | 17 Piezas |

Polietileno



Consultar para otras medidas y colores.

Certificado ISO 9001-2008.
Inscripción registro sanitario.
Certificado Garantía Sanitaria.

Tablas Polietileno

| Tamaño | 20 mm | 30 mm | 40 mm | 50 mm |
|---------|--------|--------|--------|--------|
| 300x200 | 322000 | 323000 | 424000 | 425000 |
| 400x200 | 422000 | 423000 | 424000 | 425000 |
| 500x300 | 532000 | 533000 | 534000 | 645000 |
| 600x400 | 442000 | 443000 | 444000 | 445000 |
| 400x400 | 442000 | 443000 | 444000 | 445000 |
| 500x500 | 552000 | 553000 | 554000 | 555000 |

Disponible en: 



Reparador Tablas
Cod. NPPR1
177x64x87 mm

Cuchilla repuesto NPPR01



Soporte Tablas

| Código | (mm) |
|--------|------|
|--------|------|

| | |
|---------|-----------------------|
| NC016 | 300x280x263; 6 Tablas |
| NC016-1 | 310x230x270; 5 Tablas |

Guantes malla



Cod. 615000
210 mm
Talla XXS



Cod. 615100
230 mm
Talla XS



Cod. 615200
240 mm
Talla S



Cod. 615300
250 mm
Talla M



Cod. 615400
270 mm
Talla L

Corte y decoración



| Referencia | Descripción |
|------------|--------------------------------------|
| 1 | 7201425 Vaciador Melón 25 mm Ø |
| | 7201510 Vaciador Patata 10 mm Ø |
| | 7201515 Vaciador Patata 15 mm Ø |
| 2 | 7201518 Vaciador Patata 18 mm Ø |
| | 7201522 Vaciador Patata 22 mm Ø |
| | 7201525 Vaciador Patata 25 mm Ø |
| | 7201530 Vaciador Patata 30 mm Ø |
| 3 | 7201210 Decorador Fruta |
| 4 | 7200516 Descorazonador Manzana 16 mm |
| | 7200620 Descorazonador Manzana 20 mm |
| 5 | 7201800 Vaciador Melón Oval |
| 6 | 7203010 Pelador Uvas |
| 7 | 7204005 Pelador Patatas |
| 8 | 7209003 Rallador Limón |
| 9 | 7209504 Acanalador Rectangular |
| 10 | 7209704 Acanalador Redondo |
| 11 | 7207507 Ruleta Lisa 7 cm Ø |
| 12 | 7207007 Ruleta Rizada 7 cm Ø |
| 13 | 7209312 Cortador Juliana |
| 14 | 7211911 Espátula Queso |
| | 7251912 Espátula Lisa 12 cm |
| 15 | 7250915 Espátula Lisa 15 cm |
| | 7250120 Espátula Lisa 20 cm |
| | 7252309 Espátula Codo 9 cm |
| 16 | 7251312 Espátula Codo 12 cm |
| | 7250220 Espátula Codo 20 cm |

Afilado



Chaira redonda

| Código | (mm) |
|--------|----------|
| 278100 | 230x10 Ø |
| 278200 | 250x13 Ø |
| 278510 | 300x13 Ø |



Chaira Oval

| Código | (mm) |
|--------|----------|
| 279010 | 300x20 Ø |



Chaira Oval Diamante

| Código | (mm) |
|--------|----------|
| 279200 | 280x17 Ø |



Afilador Manual Minosharp
Cod. 220/GB



Afilador eléctrico Waring
Cod. WKS800E
318x146x108 mm
2 piedras afilar + 1 rueda pulir

COCINA

Kitchen • Cuisine • Cucina • Küche



Batería profesional



Chef Classic

- Toda la pieza está fabricada en Acero Inoxidable 18/10
- Fondo Termodifusor (Inox 18/10 - Aluminio - Inox)
- Espesor 0,7 - 1,2 mm.
- Apta para todos los tipos de cocina (incluida indicción y horno)
- Acabado mate interior y exterior.
- Máxima garantía en cuanto a resitencia, durabilidad e higiene.



Cacerola

| Ref. | Ø (cm) | h (cm) | L |
|--------|--------|--------|-------|
| 50016 | 16 | 8,0 | 1,60 |
| 50020 | 20 | 9,0 | 2,80 |
| 50024 | 24 | 9,5 | 4,25 |
| 50028 | 28 | 11,0 | 6,75 |
| 50032 | 32 | 12,5 | 10,00 |
| 50036 | 36 | 14,0 | 14,20 |
| 50040 | 40 | 15,5 | 19,40 |
| 50045 | 45 | 17,0 | 27,00 |
| 50050 | 50 | 20,0 | 38,20 |
| 50060* | 60 | 25,0 | 70,00 |

* NO inducción · NOT induction



Cacerola alta

| Ref. | Ø (cm) | h (cm) | L |
|--------|--------|--------|-------|
| 50017 | 16 | 11,0 | 2,20 |
| 50021 | 20 | 13,0 | 4,00 |
| 50025 | 24 | 14,0 | 6,75 |
| 50029 | 28 | 17,5 | 10,00 |
| 50033 | 32 | 18,0 | 14,40 |
| 50037 | 36 | 21,5 | 21,80 |
| 50044 | 40 | 24,5 | 30,70 |
| 50046 | 45 | 27,5 | 43,70 |
| 50051 | 50 | 30,0 | 58,80 |
| 50061* | 60 | 35,0 | 98,00 |

* NO inducción · NOT induction



Olla

| Ref. | Ø (cm) | h (cm) | L |
|--------|--------|--------|--------|
| 50116 | 16 | 16,0 | 3,20 |
| 50120 | 20 | 20,2 | 6,20 |
| 50124 | 24 | 24,0 | 10,50 |
| 50128 | 28 | 28,0 | 17,20 |
| 50132 | 32 | 32,0 | 25,70 |
| 50136 | 36 | 36,0 | 36,60 |
| 50140 | 40 | 40,0 | 50,00 |
| 50145 | 45 | 45,0 | 68,30 |
| 50150 | 50 | 50,0 | 98,00 |
| 50160* | 60 | 50,0 | 141,00 |

* NO inducción · NOT induction



Olla baja

| Ref. | Ø (cm) | h (cm) | L |
|-------|--------|--------|-------|
| 50119 | 20 | 15,0 | 4,70 |
| 50123 | 24 | 20,0 | 9,00 |
| 50127 | 28 | 22,5 | 13,50 |
| 50131 | 32 | 26,0 | 20,80 |
| 50135 | 36 | 29,0 | 29,50 |
| 50139 | 40 | 32,0 | 40,00 |



Tapa

| Ref. | Ø (cm) |
|------|--------|
|------|--------|

| | |
|-------|----|
| 50916 | 16 |
| 50918 | 18 |
| 50920 | 20 |
| 50924 | 24 |
| 50928 | 28 |
| 50932 | 32 |
| 50936 | 36 |
| 50940 | 40 |
| 50945 | 45 |
| 50950 | 50 |
| 50960 | 60 |



Paellera

| Ref. | Ø (cm) | h (cm) | L |
|------|--------|--------|---|
|------|--------|--------|---|

| | | | |
|--------|----|-----|-------|
| 50624 | 24 | 6,0 | 2,70 |
| 50628 | 28 | 6,0 | 3,60 |
| 50632 | 32 | 6,0 | 5,00 |
| 50636 | 36 | 7,0 | 7,10 |
| 50640 | 40 | 8,0 | 10,00 |
| 50645 | 45 | 8,5 | 13,50 |
| 50650 | 50 | 9,0 | 17,60 |
| 50660* | 60 | 9,0 | 25,40 |

* NO inducción · NOT induction



Cazo Recto

| Ref. | Ø (cm) | h (cm) | L |
|------|--------|--------|---|
|------|--------|--------|---|

| | | | |
|-------|----|------|------|
| 50212 | 12 | 7,0 | 0,75 |
| 50214 | 14 | 7,5 | 1,10 |
| 50216 | 16 | 8,0 | 1,60 |
| 50218 | 18 | 9,0 | 2,20 |
| 50220 | 20 | 9,0 | 2,80 |
| 50224 | 24 | 9,5 | 4,25 |
| 50228 | 28 | 11,0 | 6,75 |



Cazo Recto Alto

| Ref. | Ø (cm) | h (cm) | L |
|------|--------|--------|---|
|------|--------|--------|---|

| | | | |
|-------|----|------|-------|
| 50217 | 16 | 11,0 | 2,10 |
| 50219 | 18 | 12,0 | 3,00 |
| 50221 | 20 | 13,0 | 4,00 |
| 50225 | 24 | 14,0 | 6,30 |
| 50229 | 28 | 17,5 | 10,20 |



Cazo Francés

| Ref. | Ø (cm) | h (cm) | L |
|------|--------|--------|---|
|------|--------|--------|---|

| | | | |
|--------|----|------|------|
| 50225N | 24 | 12,0 | 5,50 |
| 50229N | 28 | 14,0 | 8,50 |



Cazo Cónico

| Ref. | Ø (cm) | h (cm) | L |
|------|--------|--------|---|
|------|--------|--------|---|

| | | | |
|-------|----|-----|------|
| 51216 | 16 | 6,0 | 1,00 |
| 51218 | 18 | 6,0 | 1,20 |
| 51220 | 20 | 6,5 | 1,60 |
| 51222 | 24 | 7,0 | 2,10 |
| 51224 | 28 | 7,5 | 2,70 |



Sautex

| Ref. | Ø (cm) | h (cm) | L |
|------|--------|--------|---|
|------|--------|--------|---|

| | | | |
|-------|----|------|------|
| 50625 | 24 | 6,5 | 2,70 |
| 50629 | 28 | 7,0 | 4,00 |
| 50633 | 32 | 8,5 | 4,70 |
| 50637 | 36 | 10,0 | 7,00 |



Baño María

| Ref. | Ø (cm) | h (cm) | L |
|------|--------|--------|---|
|------|--------|--------|---|

| | | | |
|-------|----|------|------|
| 50717 | 16 | 16,0 | 3,20 |
| 50721 | 20 | 20,0 | 6,20 |

Batería cocina

pujadas
A VOLKRATH® COMPANY

PROFESSIONAL COOKWARE

Inox-Pro

- Cuerpo Acero Inoxidable 18/10
- Asas soldadas de varilla matizada.
- Espesor 0,7 - 1,2 mm.
- Soldadura artesanal.
- Fondo Sandwich.



Cacerola

| Ref. | Ø (cm) | h (cm) | L |
|---------|--------|--------|-------|
| 207.116 | 16 | 7,5 | 1,50 |
| 207.018 | 18 | 8,0 | 2,00 |
| 207.020 | 20 | 8,0 | 2,50 |
| 207.024 | 24 | 9,5 | 4,30 |
| 207.028 | 28 | 11,0 | 6,70 |
| 207.030 | 30 | 12,0 | 8,40 |
| 207.032 | 32 | 12,5 | 10,00 |
| 207.035 | 35 | 14,0 | 13,60 |
| 207.040 | 40 | 15,5 | 19,50 |
| 207.045 | 45 | 17,0 | 27,00 |
| 207.050 | 50 | 20,0 | 39,00 |
| 207.060 | 60 | 23,0 | 65,00 |



Olla

| Ref. | Ø (cm) | h (cm) | L |
|---------|--------|--------|--------|
| 208.016 | 16 | 16,0 | 3,00 |
| 208.018 | 18 | 18,0 | 4,50 |
| 208.020 | 20 | 20,0 | 6,20 |
| 208.024 | 24 | 24,0 | 10,00 |
| 208.028 | 28 | 28,0 | 16,50 |
| 208.030 | 30 | 30,0 | 21,20 |
| 208.032 | 32 | 32,0 | 24,00 |
| 208.035 | 35 | 35,0 | 33,60 |
| 208.040 | 40 | 40,0 | 50,00 |
| 208.045 | 45 | 45,0 | 72,00 |
| 208.050 | 50 | 50,0 | 98,00 |
| 208.060 | 60 | 55,0 | 155,00 |



Cacerola alta

| Ref. | Ø (cm) | h (cm) | L |
|---------|--------|--------|-------|
| 206.016 | 16 | 11,0 | 2,10 |
| 206.016 | 18 | 12,0 | 3,00 |
| 206.016 | 20 | 13,0 | 4,00 |
| 206.016 | 24 | 14,0 | 6,30 |
| 206.016 | 28 | 17,5 | 10,20 |
| 206.016 | 30 | 18,0 | 12,70 |
| 206.016 | 32 | 19,0 | 15,20 |
| 206.016 | 35 | 21,0 | 20,20 |
| 206.016 | 40 | 25,0 | 31,40 |
| 206.016 | 45 | 28,0 | 44,50 |
| 206.016 | 50 | 30,0 | 59,00 |
| 206.016 | 60 | 35,0 | 99,00 |



Paellera

| Ref. | Ø (cm) | h (cm) | L |
|---------|--------|--------|-------|
| 215.020 | 20 | 6,0 | 1,90 |
| 215.024 | 24 | 6,0 | 2,70 |
| 215.028 | 28 | 6,0 | 3,70 |
| 215.030 | 30 | 6,0 | 4,30 |
| 215.032 | 32 | 6,0 | 4,70 |
| 215.035 | 35 | 7,0 | 6,70 |
| 215.040 | 40 | 8,0 | 10,00 |
| 215.045 | 45 | 8,5 | 12,00 |
| 215.050 | 50 | 9,0 | 17,50 |
| 215.060 | 60 | 10,0 | 28,00 |



Cazo Francés

| Ref. | Ø (cm) | h (cm) | L |
|---------|--------|--------|------|
| 200.012 | 12 | 7,0 | 0,70 |
| 200.014 | 14 | 7,0 | 1,00 |
| 200.016 | 16 | 7,5 | 1,50 |
| 200.018 | 18 | 9,0 | 2,30 |
| 200.020 | 20 | 10,0 | 3,10 |
| 200.022 | 22 | 11,0 | 4,20 |
| 200.024 | 24 | 12,0 | 5,40 |
| 200.028 | 28 | 14,0 | 8,60 |



Cazo Recto

| Ref. | Ø (cm) | h (cm) | L |
|----------|--------|--------|-------|
| 201.016 | 16 | 7,5 | 1,50 |
| 201.018 | 18 | 8,0 | 2,00 |
| 201.020 | 20 | 8,0 | 2,50 |
| 201.024 | 24 | 9,5 | 4,30 |
| 201.028 | 28 | 11,0 | 6,70 |
| 201.032* | 32 | 12,5 | 10,00 |

*Con contraasa



Cazo Recto Alto

| Ref. | Ø (cm) | h (cm) | L |
|----------|--------|--------|-------|
| 202.016 | 16 | 11,0 | 2,10 |
| 202.018 | 18 | 12,0 | 3,00 |
| 202.020 | 20 | 13,0 | 4,00 |
| 202.024 | 24 | 14,0 | 6,30 |
| 202.028 | 28 | 17,5 | 10,20 |
| 202.032* | 32 | 19,0 | 15,20 |

*Con contraasa



Cazo Cónico

| Ref. | Ø (cm) | h (cm) | L |
|---------|--------|--------|------|
| 214.016 | 16 | 6,0 | 1,00 |
| 214.018 | 18 | 6,0 | 1,20 |
| 214.020 | 20 | 6,5 | 1,60 |
| 214.022 | 22 | 7,0 | 2,10 |
| 214.024 | 24 | 7,5 | 2,70 |



Cazo con Picos

| Ref. | Ø (cm) | h (cm) | L |
|---------|--------|--------|------|
| 200.116 | 16 | 7,5 | 1,50 |
| 200.120 | 20 | 10,0 | 3,10 |



Cazo Bombado

| Ref. | Ø (cm) | h (cm) | L |
|---------|--------|--------|------|
| 200.320 | 20 | 7,5 | 1,80 |
| 200.324 | 24 | 8,5 | 3,00 |



Pote

| Ref. | Ø (cm) | h (cm) | L |
|---------|--------|--------|------|
| 210.016 | 16 | 16,0 | 3,00 |
| 210.018 | 18 | 18,0 | 4,50 |
| 210.020 | 20 | 20,0 | 6,20 |



Baño María

| Ref. | Ø (cm) | h (cm) | L |
|---------|--------|--------|-------|
| 203.016 | 16 | 16,0 | 3,00 |
| 203.018 | 18 | 18,0 | 4,50 |
| 203.020 | 20 | 20,0 | 6,20 |
| 203.024 | 24 | 24,0 | 10,00 |



Sautex

| Ref. | Ø (cm) | h (cm) | L |
|----------|--------|--------|-------|
| 204.020 | 20 | 6,0 | 1,90 |
| 204.024 | 24 | 6,0 | 2,70 |
| 204.028 | 28 | 6,0 | 3,70 |
| 204.030 | 30 | 6,0 | 4,30 |
| 204.032 | 32 | 6,0 | 4,70 |
| 204.035 | 35 | 7,0 | 6,70 |
| 204.040* | 40 | 8,0 | 10,00 |

*Con contraasa

Ollas presión



Chef

- Acero Inoxidable 18/10

| Ref. | Ø (cm) | h (cm) | L |
|------|--------|--------|---|
|------|--------|--------|---|

| | | | |
|-------|----|------|-------|
| 71815 | 28 | 25,0 | 15,00 |
| 71821 | 28 | 33,0 | 20,00 |



Robust

- Aluminio 99,55% pureza
- Triple sistema de seguridad

| Ref. | Ø (cm) | h (cm) | L |
|------|--------|--------|---|
|------|--------|--------|---|

| | | | |
|-------|----|------|-------|
| 20830 | 42 | 31,0 | 30,00 |
| 20840 | 42 | 39,0 | 40,00 |
| 20850 | 42 | 46,0 | 50,00 |



Pro-classic

- Uso profesional
- Aluminio 99,55% pureza

| Ref. | Ø (cm) | h (cm) | L |
|------|--------|--------|---|
|------|--------|--------|---|

| | | | |
|-------|----|------|-------|
| 20518 | 32 | 23,0 | 18,00 |
| 20522 | 34 | 23,0 | 22,00 |



Pro-classic alta

- Uso profesional
- Aluminio 99,55% pureza

| Ref. | Ø (cm) | h (cm) | L |
|------|--------|--------|---|
|------|--------|--------|---|

| | | | |
|-------|----|------|-------|
| 20615 | 27 | 27,5 | 15,00 |
| 20618 | 27 | 32,5 | 18,00 |



Classic

- Uso doméstico
- Acero inoxidable 18/10

| Ref. | Ø (cm) | h (cm) | L |
|------|--------|--------|---|
|------|--------|--------|---|

| | | | |
|-------|----|------|-------|
| 71874 | 22 | 11,5 | 4,00 |
| 71876 | 22 | 17,0 | 6,00 |
| 71878 | 24 | 19,0 | 8,00 |
| 71871 | 24 | 23,0 | 10,00 |
| 71872 | 26 | 23,0 | 12,00 |
| 71875 | 26 | 29,0 | 15,00 |



Rustideras



Rustidera Chef-inox

• Acero Inoxidable 18/10

| Ref. | cm | h (cm) |
|-------|-------|--------|
| 50540 | 40x30 | 8,0 |
| 50550 | 50x40 | 8,0 |
| 50560 | 60x45 | 8,0 |
| 50570 | 70x45 | 9,5 |



Rustidera s/asas

• Acero Inoxidable 18/10

| Ref. | cm | h (cm) |
|-------|-------|--------|
| 62530 | 30x21 | 5,5 |
| 62535 | 35x26 | 5,5 |
| 62540 | 40x31 | 6,0 |



Rustidera a/abatible

• Acero Inoxidable 18% Cr

| Ref. | cm | h (cm) |
|-------|-------|--------|
| 61530 | 30x22 | 5,0 |
| 61535 | 35x26 | 5,3 |
| 61540 | 40x28 | 5,6 |
| 61545 | 45x32 | 7,5 |
| 61550 | 50x36 | 8,5 |



Rustidera Honda a/abatible

• Acero Inoxidable 18/10

| Ref. | cm | h (cm) |
|--------|-------|--------|
| 62530A | 30x22 | 7,5 |
| 62535A | 35x26 | 7,8 |
| 62540A | 40x28 | 8,5 |
| 62545A | 45x32 | 9,0 |



Rustidera Robust

• Aluminio antiadherente

| Ref. | cm | h (cm) |
|--------|-------|--------|
| 23540A | 40x30 | 6,0 |
| 23550A | 50x35 | 8,0 |



Rustidera a/abatible

• Aluminio

| Ref. | cm | h (cm) | e (cm) | L |
|--------|-------|--------|--------|-------|
| 20540A | 40x30 | 6,2 | 2,5 | 7,45 |
| 20545A | 45x32 | 6,2 | 2,5 | 10,40 |
| 20550A | 50x35 | 7,0 | 3,0 | 12,60 |
| 20555A | 55x37 | 7,7 | 3,0 | 16,30 |
| 20560A | 60x40 | 7,7 | 3,0 | 18,95 |
| 20565A | 65x43 | 7,9 | 3,0 | 24,30 |
| 20570A | 70x45 | 9,0 | 3,0 | 28,65 |



Rustidera a/fija

• Aluminio

| Ref. | cm | h (cm) | e (cm) | L |
|--------|-------|--------|--------|-------|
| 20540F | 40x30 | 6,2 | 2,5 | 7,45 |
| 20545F | 45x32 | 6,2 | 2,5 | 10,40 |
| 20550F | 50x35 | 7,0 | 3,0 | 12,60 |
| 20555F | 55x37 | 7,7 | 3,0 | 16,30 |
| 20560F | 60x40 | 7,7 | 3,0 | 18,95 |
| 20565F | 65x43 | 7,9 | 3,0 | 24,30 |
| 20570F | 70x45 | 9,0 | 3,0 | 28,65 |

Utensilios



Escurreidera cónica

| Ref. | Ø (cm) | h (cm) | L |
|-------|--------|--------|-------|
| 50829 | 28 | 17,0 | 13,20 |
| 50833 | 32 | 20,0 | 14,50 |
| 50837 | 36 | 23,0 | 16,00 |
| 50841 | 40 | 26,0 | 18,00 |
| 50846 | 45 | 29,0 | 20,00 |
| 50851 | 50 | 33,0 | 22,00 |



Escurreidera c/base

| Ref. | Ø (cm) | h (cm) | L |
|-------|--------|--------|-------|
| 50332 | 32 | 18,0 | 9,50 |
| 50336 | 36 | 19,0 | 12,00 |
| 50340 | 40 | 21,0 | 14,50 |



Escurrefritos

| Ref. | cm | h (cm) |
|-------|-------|--------|
| 50541 | 40x29 | 8,0 |
| 50551 | 50x39 | 8,0 |
| 50561 | 60x39 | 8,0 |



Harinero

| Ref. | cm |
|-------|------------|
| 50438 | 18x37x26,5 |
| 50450 | 18x50x26,5 |



Colador 4 sectores

• Combinables con cacerola alta de 36,40 cm.

| Ref. | Ø (cm) | h (cm) |
|-------|--------|--------|
| 50335 | 36 | 23,0 |
| 50339 | 40 | 26,0 |



Utensilios



Hervidor pescado

| Ref. | (cm) | h (cm) | L |
|-------|-------|--------|-------|
| 50440 | 40x19 | 11 | 10,05 |
| 50445 | 50x17 | 11 | 13,80 |
| 50460 | 60x19 | 11 | 20,80 |



Vaporera

| Ref. | Ø (cm) | h (cm) |
|-------|--------|--------|
| 50428 | 28 | 11,0 |
| 50432 | 32 | 12,5 |



Cuscusera

| Ref. | Ø (cm) | h (cm) | L |
|-------|---------|--------|------|
| 50437 | 30x16,5 | 28 | 15,0 |
| 50441 | 40x22 | 32 | 22,0 |

Batidores



Batidor universal

| Ref. | L (cm) |
|---------|--------|
| 2610.25 | 26,5 |
| 2610.30 | 32,0 |
| 2610.35 | 37,0 |
| 2610.40 | 41,5 |
| 2610.45 | 46,5 |
| 2610.50 | 50,0 |



Batidor fiberglass

| Ref. | L (cm) |
|-------|--------|
| 61624 | 25 |
| 61629 | 30 |
| 61634 | 35 |
| 61639 | 40 |
| 61644 | 45 |
| 61649 | 50 |



Batidor extra

| Ref. | L (cm) |
|-------|--------|
| 61626 | 25 |
| 61631 | 30 |
| 61636 | 35 |
| 61641 | 40 |
| 61646 | 45 |
| 61651 | 50 |



Batidor mini

| Ref. | L (cm) |
|-------|--------|
| 61615 | 15 |
| 61620 | 20 |



Batidor gigante

| Ref. | L (cm) |
|-------|--------|
| 61610 | 100 |
| 61612 | 129 |

Utensilios cocina



Cacillo

| Ref. | Ø (cm) | h (cm) | L |
|-------|--------|--------|------|
| 60306 | 6,50 | 33,50 | 0,07 |
| 60308 | 8,00 | 33,50 | 0,12 |
| 60309 | 9,00 | 44,50 | 0,20 |
| 60310 | 10,00 | 44,50 | 0,25 |
| 60312 | 12,00 | 49,00 | 0,50 |
| 60314 | 14,00 | 54,00 | 0,75 |
| 60316 | 16,00 | 55,50 | 1,00 |



Cuchara lisa

| Ref. | Ø (cm) | L (cm) |
|-------|--------|--------|
| 60507 | 7,50 | 47 |



Espátula lisa

| Ref. | (cm) | L (cm) |
|-------|------|--------|
| 61410 | 10 | 49,50 |
| 61412 | 12 | 50,50 |



Espumadera

| Ref. | Ø (cm) | L (cm) |
|-------|--------|--------|
| 60408 | 8 | 34,00 |
| 60410 | 10 | 48,00 |
| 60412 | 12 | 49,50 |
| 60414 | 14 | 55,00 |
| 60416 | 16 | 57,00 |



Cuchara oblicua

| Ref. | Ø (cm) | ml |
|-------|--------|----|
| 60509 | 7,5x34 | 70 |



Cacillo perforado

| Ref. | Ø (cm) | h (cm) | L |
|-------|--------|--------|------|
| 61308 | 8 | 39 | 0,12 |
| 61310 | 10 | 46 | 0,25 |
| 61312 | 12 | 47 | 0,50 |



Cuchara perforada

| Ref. | Ø (cm) | L (cm) |
|-------|--------|--------|
| 60508 | 7,50 | 47 |



Espátula perforada

| Ref. | (cm) | L (cm) |
|-------|------|--------|
| 61411 | 10 | 49,50 |
| 61413 | 12 | 50,50 |



Paleta pescado

| Ref. | (cm) | L (cm) |
|-------|--------|--------|
| 62988 | 20,5x8 | 37,00 |



Tenedor

| Ref. | Puntas | L (cm) | cm |
|-------|--------|--------|-----|
| 60002 | 2 | 57 | 7x7 |
| 60003 | 3 | 57 | 7x7 |

Espumadera alambre

| Ref. | Ø (cm) | L (cm) |
|-------|--------|--------|
| 60409 | 10 | 47,50 |
| 60411 | 12 | 50,00 |
| 60413 | 14 | 51,00 |
| 60415 | 16 | 53,00 |
| 60417 | 18 | 62,00 |
| 60419 | 20 | 62,00 |
| 60423 | 24 | 73,00 |
| 60427 | 28 | 73,00 |



Rasera alambre

| Ref. | Ø (cm) | L (cm) |
|-------|--------|--------|
| 67410 | 10 | 37,00 |
| 67412 | 12 | 44,00 |
| 67415 | 15 | 55,50 |
| 67417 | 17 | 56,00 |
| 67420 | 20 | 58,00 |

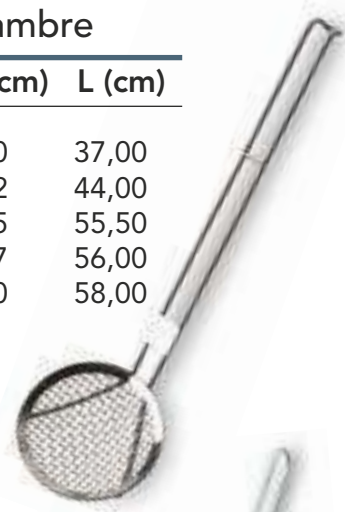

Espumadera alambre estaño

| Ref. | Ø (cm) | L (cm) |
|-------|--------|--------|
| 63514 | 14 | 54,00 |
| 63516 | 16 | 56,50 |
| 63518 | 18 | 56,50 |
| 63520 | 20 | 67,00 |
| 63524 | 24 | 70,50 |
| 63528 | 28 | 76,00 |



Tenedor estaño

| Ref. | L (cm) | cm |
|-------|--------|-------|
| 64040 | 40,50 | 7x7 |
| 64060 | 60,50 | 7,5x9 |

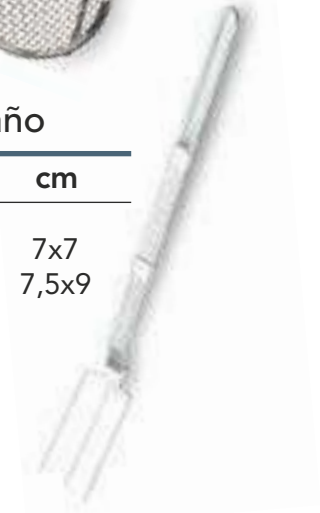

Super Mono Block



Cacillo

| Ref. | ml | L (cm) |
|-------|-----|--------|
| 62603 | 100 | 31,00 |



Espumadera

| Ref. | L (cm) |
|-------|--------|
| 62604 | 36,50 |



Tenedor

| Ref. | L (cm) |
|-------|--------|
| 62605 | 33,50 |



Espátula

| Ref. | L (cm) |
|-------|--------|
| 62606 | 33,50 |



Cuchara lisa

| Ref. | L (cm) |
|-------|--------|
| 62607 | 32,00 |



Cuchara perforada

| Ref. | L (cm) |
|-------|--------|
| 62608 | 32,00 |



Cacillo salsa

| Ref. | ml | L (cm) |
|-------|----|--------|
| 62609 | 30 | 31,00 |



Cacillo spaghetti

| Ref. | L (cm) |
|-------|--------|
| 62811 | 31,00 |

Batería aluminio fundido

Efficient

- Apto para lavavajillas.
- Apto para todo tipo de fuegos.
- Recubrimiento antiadherente Teflón® Platinum Plus.
- Tecnología Eco+: 100% libre PFOA.
- Asas silicón desmontables.
- 6 mm. espesor.



Cacerola alta

| Ref. | Ø (cm) | L |
|--------|--------|------|
| 270320 | 20 | 3,0 |
| 270324 | 24 | 4,0 |
| 270328 | 28 | 5,7 |
| 270332 | 32 | 8,3 |
| 270336 | 36 | 11,2 |



Cacerola baja

| Ref. | Ø (cm) | L |
|----------|--------|------|
| 270516 | 16 | 0,8 |
| 270520 | 20 | 1,5 |
| 270524 | 24 | 2,3 |
| 270528 | 28 | 3,1 |
| 270530 | 30 | 4,1 |
| 270532 | 32 | 5,0 |
| 270536 | 36 | 7,1 |
| 270540 | 40 | 9,0 |
| 270545* | 45 | 12,0 |
| 274345** | 45 | |

*Sin Tapa

** Tapa Inox Ø45



Olla alta

| Ref. | Ø (cm) | L |
|--------|--------|------|
| 273903 | 20 | 4,1 |
| 273905 | 24 | 6,8 |
| 273907 | 28 | 11,1 |



Wok

| Ref. | Ø (cm) | L |
|--------|--------|-----|
| 272024 | 24 | 3,0 |
| 272028 | 28 | 4,2 |
| 272032 | 32 | 5,5 |



Parrilla

| Ref. | Ø (cm) |
|------|--------|
|------|--------|

| | |
|---------|----|
| 271535* | 35 |
|---------|----|

| | |
|---------|----|
| 271545* | 45 |
|---------|----|

* Las asas de silicona se venden por separado.

Asas de silicona parrilla (blister 2 und.)

| Ref. | Ø (cm) |
|------|--------|
|------|--------|

| | |
|--------|-------|
| 284008 | 35-45 |
|--------|-------|



Paellera

| Ref. | Ø (cm) | raciones |
|------|--------|----------|
|------|--------|----------|

| | | |
|--------|----|---|
| 271632 | 32 | 5 |
|--------|----|---|

| | | |
|--------|----|---|
| 271636 | 36 | 7 |
|--------|----|---|

| | | |
|--------|----|---|
| 271640 | 40 | 9 |
|--------|----|---|



Cazo

| Ref. | Ø (cm) |
|------|--------|
|------|--------|

| | |
|--------|----|
| 273816 | 16 |
|--------|----|



Crepera

| Ref. | Ø (cm) |
|------|--------|
|------|--------|

| | |
|--------|----|
| 272526 | 26 |
|--------|----|



Sartén

| Ref. | Ø (cm) |
|------|--------|
|------|--------|

| | |
|--------|----|
| 271216 | 16 |
|--------|----|

| | |
|--------|----|
| 271218 | 18 |
|--------|----|

| | |
|--------|----|
| 271220 | 20 |
|--------|----|

| | |
|--------|----|
| 271222 | 22 |
|--------|----|

| | |
|--------|----|
| 271224 | 24 |
|--------|----|

| | |
|--------|----|
| 271226 | 26 |
|--------|----|

| | |
|--------|----|
| 271228 | 28 |
|--------|----|

| | |
|--------|----|
| 271230 | 30 |
|--------|----|



Grill

| Ref. | Ø (cm) |
|------|--------|
|------|--------|

| | |
|--------|----|
| 271322 | 22 |
|--------|----|

| | |
|--------|----|
| 271328 | 28 |
|--------|----|



Grill c/rayas

| Ref. | Ø (cm) |
|------|--------|
|------|--------|

| | |
|--------|----|
| 271422 | 22 |
|--------|----|

| | |
|--------|----|
| 271428 | 28 |
|--------|----|

Batería cobre

- Apto para lavavajillas.
- Apto para todo tipo de fuegos.
- Recubrimiento antiadherente Teflón® Platinum Plus.
- Tecnología Eco+: 100% libre PFOA.
- Asas silicona desmontables.
- 6 mm. espesor.



Cacerola baja

| Ref. | Ø (cm) | h (cm) | L |
|---------|--------|--------|-----|
| 6446.20 | 20 | 6 | 1,8 |
| 6446.24 | 24 | 7 | 3,2 |
| 6446.28 | 28 | 9 | 5,5 |



Cacerola

| Ref. | Ø (cm) | h (cm) | L |
|---------|--------|--------|-----|
| 6447.16 | 16 | 8 | 1,6 |
| 6447.20 | 20 | 10 | 3,5 |
| 6447.24 | 24 | 11,5 | 5,2 |



Sartén

| Ref. | Ø (cm) | L |
|---------|--------|---|
| 6449.12 | 12 | 2 |
| 6449.16 | 16 | 3 |
| 6449.20 | 20 | 4 |
| 6449.24 | 24 | 4 |



Sartén c/asas

| Ref. | Ø (cm) | L |
|---------|--------|---|
| 6450.20 | 20 | 4 |
| 6450.24 | 24 | 4 |
| 6450.28 | 28 | 4 |



Sarten oval

| Ref. | Ø (cm) | h (cm) | L |
|---------|--------|--------|-----|
| 6451.32 | 23 | 32 | 4,5 |
| 6451.36 | 26,2 | 36 | 4,5 |



Cazo recto

| Ref. | Ø (cm) | h (cm) | L |
|---------|--------|--------|-----|
| 6445.10 | 10 | 5,5 | |
| 6445.12 | 12 | 6 | 0,8 |
| 6445.14 | 14 | 7 | 1 |
| 6445.16 | 16 | 8,5 | 1,6 |
| 6445.18 | 18 | 9 | 2,5 |
| 6445.20 | 20 | 10 | 3,5 |



Cazo recto bajo

| Ref. | Ø (cm) | h (cm) | L |
|---------|--------|--------|-----|
| 6448.16 | 16 | 5 | 1 |
| 6448.20 | 20 | 6 | 1,8 |
| 6448.24 | 24 | 6,5 | 3 |



Work

| Ref. | Ø (cm) | L |
|---------|--------|-----|
| 6432.32 | 30,9 | 8,5 |



Perol esférico

| Ref. | Ø (cm) | h (cm) | L |
|----------|--------|--------|------|
| 6580.26N | 26 | 13 | 4,5 |
| 6580.30N | 30 | 15 | 7 |
| 6580.40N | 40 | 20 | 16,7 |
| 6581.30N | 30 | 15 | 7 |



Perol plano

| Ref. | Ø (cm) | h (cm) | L |
|----------|--------|--------|----|
| 6200.38N | 38 | 15 | 9 |
| 6202.40N | 40 | 14,4 | 11 |

Mini utensilios



Cacillo para salsa con tapadera

| Ref. | Ø (cm) | h (cm) | L |
|---------|--------|--------|-----|
| 6453.09 | 9 | 4,5 | 0,3 |



Cacillo para salsa

| Ref. | Ø (cm) | h (cm) | L |
|---------|--------|--------|-----|
| 6445.09 | 9 | 4,5 | 0,3 |
| 6445.10 | 10 | 5,5 | |



Mini cacerola con monturas

| Ref. | Ø (cm) | h (cm) | L |
|---------|--------|--------|---|
| 6447.10 | 10 | 5,5 | |



Mini sarten

| Ref. | Ø (cm) | h (cm) | L |
|---------|--------|--------|---|
| 6445.09 | 9,3 | 3,2 | |

Sartenes



Ergos

Ref. Ø (cm) h (cm)

| | | |
|---------|----|-----|
| 120.018 | 18 | 4,0 |
| 120.020 | 20 | 4,0 |
| 120.022 | 22 | 4,5 |
| 120.024 | 24 | 4,5 |
| 120.026 | 26 | 5,0 |
| 120.028 | 28 | 5,0 |
| 120.032 | 32 | 5,5 |
| 120.036 | 36 | 6,0 |
| 120.040 | 40 | 6,5 |

Aluminio 4/5 mm.
Antiadherente



Ergos Excalibur

Ref. Ø (cm) h (cm)

| | | |
|---------|----|-----|
| 220.018 | 18 | 3,5 |
| 220.020 | 20 | 3,8 |
| 220.022 | 22 | 4,2 |
| 220.024 | 24 | 4,6 |
| 220.026 | 26 | 5,0 |
| 220.028 | 28 | 5,5 |
| 220.032 | 32 | 6,0 |
| 220.036 | 36 | 6,0 |
| 220.040 | 40 | 6,5 |

Acero inoxidable 18/10
Antiadherente
Fondo sandwich



Chef tricapa

Ref. Ø (cm) h (cm)

| | | |
|-------|----|-----|
| 21618 | 18 | 3,8 |
| 21620 | 20 | 4,0 |
| 21622 | 22 | 4,0 |
| 21624 | 24 | 4,5 |
| 21626 | 26 | 4,5 |
| 21628 | 28 | 4,5 |
| 21632 | 32 | 4,7 |
| 21636 | 36 | 5,5 |
| 21640 | 40 | 5,5 |

Aluminio 2,5/4 mm.
Antiadherente 3 capas



Choc

Ref. Ø (cm) h (cm)

| | | |
|---------|----|-----|
| 8180.20 | 20 | 3 |
| 8180.24 | 24 | 3,5 |
| 8180.26 | 26 | 3,7 |
| 8180.28 | 28 | 3,8 |
| 8180.30 | 30 | 4,5 |
| 8180.32 | 32 | 4,5 |
| 8180.36 | 36 | 4,7 |
| 8180.40 | 40 | 5,3 |

Aluminio 4/5 mm.
Antiadherente 5 capas





Aire

| Ref. | Ø (cm) | h (cm) |
|------|--------|--------|
|------|--------|--------|

| | | |
|---------|----|-----|
| 4641.25 | 20 | 4,0 |
| 4649.25 | 22 | 4,0 |
| 4642.25 | 24 | 4,5 |
| 4643.25 | 26 | 4,5 |
| 4644.25 | 28 | 4,5 |
| 4645.25 | 30 | 5,0 |

Marca: Yalira
Fundición aluminio
Antiadherente



Dynamic

| Ref. | Ø (cm) | h (cm) |
|------|--------|--------|
|------|--------|--------|

| | | |
|-------|----|-----|
| 23420 | 20 | 4,0 |
| 23424 | 24 | 4,5 |
| 23428 | 28 | 4,5 |
| 23432 | 32 | 4,7 |
| 23436 | 36 | 5,5 |

Fundición aluminio
Antiadherente



Mineral

| Ref. | Ø (cm) | h (cm) |
|------|--------|--------|
|------|--------|--------|

| | | |
|---------|----|-----|
| 5610.20 | 20 | 3,3 |
| 5610.24 | 24 | 3,5 |
| 5610.26 | 26 | 4 |
| 5610.28 | 28 | 4 |
| 5610.32 | 32 | 4,5 |
| 5610.36 | 36 | 5 |

Hierro 2,5/3 mm
Protección anti-oxidación



Lyonesa

| Ref. | Ø (cm) | h (cm) |
|------|--------|--------|
|------|--------|--------|

| | | |
|---------|----|-----|
| 5020.14 | 14 | 3,3 |
| 5020.16 | 16 | 3,3 |
| 5020.18 | 18 | 3,6 |
| 5020.20 | 20 | 4 |
| 5020.22 | 22 | 4 |
| 5020.24 | 24 | 4,5 |
| 5020.26 | 26 | 4,5 |
| 5020.28 | 28 | 4,7 |
| 5020.30 | 30 | 5 |
| 5020.32 | 32 | 5,5 |
| 5020.36 | 36 | 6 |
| 5020.40 | 40 | 6,5 |
| 5020.45 | 45 | 7,5 |

Hierro azul 1/1,5 mm
Rápida difusión de calor



Paellas



Paella pulida

| Ref. | Ø (cm) | raciones | asas |
|-------|--------|----------|------|
| 0124 | 24 | 1 | 2 |
| 0126 | 26 | 2 | 2 |
| 0128 | 28 | 3 | 2 |
| 0130 | 30 | 4 | 2 |
| 0132 | 32 | 5 | 2 |
| 0134 | 34 | 6 | 2 |
| 0136 | 36 | 7 | 2 |
| 0138 | 38 | 8 | 2 |
| 0140 | 40 | 9 | 2 |
| 0142 | 42 | 10 | 2 |
| 0146 | 46 | 12 | 2 |
| 0150 | 50 | 13 | 2 |
| 0155 | 55 | 16 | 2 |
| 0160 | 60 | 20 | 2 |
| 0165 | 65 | 25 | 2 |
| 0170 | 70 | 30 | 2 |
| 0180 | 80 | 40 | 4 |
| 0190 | 90 | 50 | 4 |
| 01100 | 100 | 85 | 4 |
| 01115 | 115 | 120 | 4 |
| 01130 | 130 | 200 | 6 |



Paella esmaltada

| Ref. | Ø (cm) | raciones | asas |
|-------|--------|----------|------|
| 0224 | 24 | 1 | 2 |
| 0226 | 26 | 2 | 2 |
| 0228 | 28 | 3 | 2 |
| 0230 | 30 | 4 | 2 |
| 0232 | 32 | 5 | 2 |
| 0234 | 34 | 6 | 2 |
| 0236 | 36 | 7 | 2 |
| 0238 | 38 | 8 | 2 |
| 0240 | 40 | 9 | 2 |
| 0242 | 42 | 10 | 2 |
| 0246 | 46 | 12 | 2 |
| 0250 | 50 | 13 | 2 |
| 0255 | 55 | 16 | 2 |
| 0260 | 60 | 20 | 2 |
| 0265 | 65 | 25 | 2 |
| 0270 | 70 | 30 | 2 |
| 0280 | 80 | 40 | 4 |
| 0290 | 90 | 50 | 4 |
| 02100 | 100 | 85 | 4 |
| 02115 | 115 | 120 | 4 |

Sarten esmaltada honda

| Ref. | Ø (cm) | asas |
|------|--------|------|
| 0622 | 22 | 2 |
| 0624 | 24 | 2 |
| 0626 | 26 | 2 |
| 0628 | 28 | 2 |
| 0630 | 30 | 2 |
| 0632 | 32 | 2 |
| 0634 | 34 | 2 |
| 0636 | 36 | 2 |
| 0638 | 38 | 2 |
| 0640 | 40 | 2 |
| 0645 | 45 | 2 |
| 0650 | 50 | 2 |
| 0655 | 55 | 2 |
| 0660 | 60 | 2 |
| 0665 | 65 | 2 |



Paellas

| Ref. | Ø (cm) |
|------|--------|
| 0210 | 10 |
| 0212 | 12 |
| 0215 | 15 |
| 0220 | 20 |

Sartenes

| Ref. | Ø (cm) |
|------|--------|
| 0614 | 14 |
| 0616 | 16 |
| 0618 | 18 |
| 0620 | 20 |



Tripode

| Ref. | unidades |
|------|----------|
| 1800 | 5 |

Paellero gas

| Ref. | Ø (cm) | fuegos | paella (cm) |
|------|--------|--------|-------------|
| 1320 | 20 | 1 | 26/36 |
| 1430 | 30 | 1 | 36/42 |
| 2635 | 35 | 2 | 20/50 |
| 2540 | 40 | 2 | 26/60 |
| 1550 | 50 | 2 | 36/70 |
| 1660 | 60 | 3 | 26/80 |
| 1770 | 70 | 3 | 36/90 |



Coladores



Cazo colador Marca: Lacor
Acero inoxidable 18/10

| Ref. | Ø (cm) | h (cm) | L |
|-------|--------|--------|-----|
| 50320 | 20 | 12 | 3,5 |
| 50324 | 24 | 14 | 6,5 |
| 50328 | 28 | 15 | 9,3 |



Colador doble malla

| Ref. | Ø (cm) | <small>Marca: Lacor Acero estañado</small> |
|-------|--------|--|
| 61316 | 16 | |
| 61318 | 18 | |
| 61320 | 20 | |
| 61323 | 23 | |
| 61326 | 26 | |
| 61330 | 30 | |
| 61335 | 35 | |



Colador 1/2 bola

| Ref. | Ø (cm) | <small>Marca: Lacor Acero inoxidable 18/10</small> |
|-------|--------|--|
| 62680 | 8 | |
| 62610 | 10 | |
| 62612 | 12 | |
| 62614 | 14 | |
| 62616 | 16 | |
| 62618 | 18 | |
| 62620 | 20 | |
| 62623 | 23 | |



Colador chino

| Ref. | Ø (cm) | <small>Marca: Lacor Acero inoxidable 18/10</small> |
|-------|--------|--|
| 60311 | 10 | |
| 60313 | 12 | |
| 60315 | 14 | |
| 60317 | 16 | |
| 60318 | 18 | |
| 60320 | 20 | |
| 60322 | 22 | |
| 60324 | 24 | |
| 60326 | 26 | |



Colador chino malla

| Ref. | Ø (cm) | <small>Marca: Lacor Acero inoxidable 18/10</small> |
|-------|--------|--|
| 60319 | 18 | |
| 60321 | 20 | |
| 60323 | 22 | |
| 60325 | 24 | |



Colador fuerte

| Ref. | Ø (cm) | <small>Marca: Inoxibar Acero inoxidable 18/10</small> |
|-------|--------|---|
| 53514 | 14 | |
| 53516 | 16 | |
| 53518 | 18 | |
| 53520 | 20 | |
| 53523 | 23 | |
| 53525 | 25 | |
| 53531 | 31 | |
| 53536 | 36 | |



Mano chino

| Ref. | cm | U.E. | <small>Marca: Lacor Polietileno</small> |
|-------|--------|------|---|
| 60400 | 28x6,5 | 6 | |



Soporte chino

| Ref. | cm | <small>Marca: Tellier Acero inoxidable</small> |
|-------|-------|--|
| N3020 | 18x28 | |

Pasapures



Pasapures profesional

Ref. Ø (cm) Marca: Lacor

| | |
|-------|----|
| 60026 | 26 |
| 60031 | 32 |



Pasapures

Ref. Ø (cm) Marca: Tellier

| | |
|--------|----|
| N3002X | 20 |
| N3004X | 24 |



Pasapures eléctrico

Ref. cm Potencia W Marca: Tellier

| | | |
|----------|--------|-----|
| EXT5T100 | 37x108 | 600 |
|----------|--------|-----|



Pasapures industrial

Ref. Ø (mm) Marca: Tellier

| | | |
|------|-----|-------------|
| X500 | | sin rejilla |
| X510 | 1 | con rejilla |
| X515 | 1,5 | con rejilla |
| X520 | 2 | con rejilla |
| X530 | 3 | con rejilla |
| X540 | 4 | con rejilla |



Rejillas pasapures industrial

Ref. Ø (mm) Marca: Tellier

| | |
|------|-----|
| X510 | 1 |
| X515 | 1,5 |
| X520 | 2 |
| X530 | 3 |
| X540 | 4 |

Morteros



Mortero granito

Ref. Ø (cm) Marca: Lacor

| | |
|-------|-------|
| 60512 | 12x8 |
| 60514 | 14x10 |
| 60516 | 16x12 |



Mortero granito

Ref. Ø (cm) Marca: Lacor

| | |
|-------|-------|
| 60517 | 12x8 |
| 60518 | 11x11 |

Dosificadores



Mini kwik

Marca: De Buyer

| Ref. | Ø (cm) | h (cm) | L |
|------|--------|--------|---|
|------|--------|--------|---|

| | | | |
|---------|----|------|-----|
| 3353.00 | 15 | 15,5 | 0,8 |
|---------|----|------|-----|



Kwik pro

Marca: De Buyer

| Ref. | Ø (cm) | h (cm) | L |
|------|--------|--------|---|
|------|--------|--------|---|

| | | | |
|---------|------|------|-----|
| 3354.00 | 19 | 18 | 1,9 |
| 3354.02 | 19 | 18 | 1,9 |
| 3354.10 | 17,5 | 16,5 | 1,5 |
| 3354.12 | 17,5 | 16,5 | 1,5 |



Kwik maxi

Marca: De Buyer

| Ref. | Ø (cm) | h (cm) | L |
|------|--------|--------|---|
|------|--------|--------|---|

| | | | |
|---------|----|----|-----|
| 3354.50 | 20 | 38 | 3,3 |
|---------|----|----|-----|



Embudo

| Ref. | cm | U.E. |
|------|----|------|
|------|----|------|

| | | |
|-------|----|---|
| 62512 | 12 | 1 |
| 62514 | 14 | 1 |
| 62516 | 16 | 1 |
| 62518 | 18 | 1 |
| 62521 | 20 | 1 |
| 62524 | 24 | 1 |



Dosificador

| Ref. | Lts |
|------|-----|
|------|-----|

| | |
|-------|---|
| 67000 | 2 |
|-------|---|



Dosificador: Le tube

| Ref. | L (cm) | L |
|------|--------|---|
|------|--------|---|

| | | |
|---------|------|------|
| 3358.00 | 38,4 | 0,75 |
|---------|------|------|



Ralladores

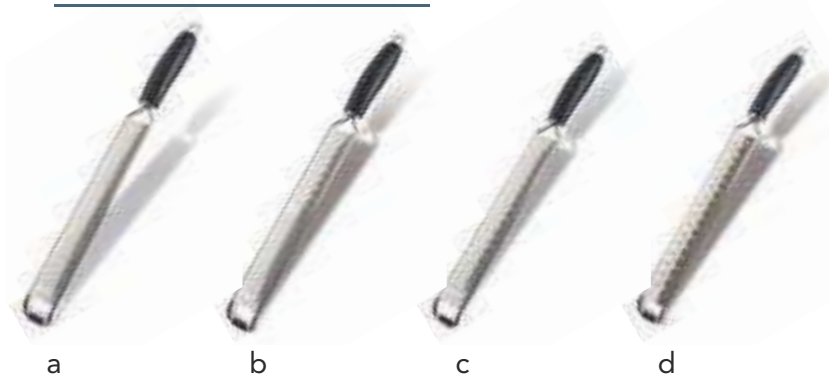

| Ref. | descripción | medida | |
|--------|--------------|----------|---|
| 322104 | Fino | 39,5x3,5 | a |
| 322101 | Dual | 39,5x3,5 | b |
| 322102 | Doble navaja | 39,5x3,5 | c |
| 322103 | Medio | 39,5x3,5 | d |

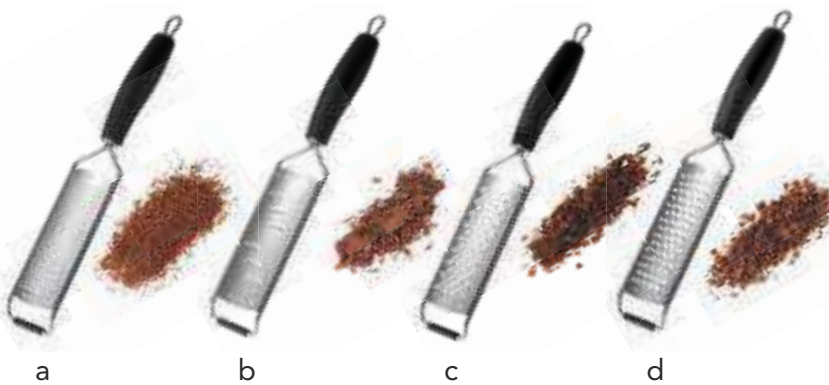

| Ref. | descripción | medida | |
|--------|--------------|----------|---|
| 322204 | Fino | 31,5x7,3 | a |
| 322201 | Tiras largas | 31,5x7,3 | b |
| 322202 | Doble navaja | 31,5x7,3 | c |
| 322203 | Grueso | 31,5x7,3 | d |



Rallador 4 caras

Ref. cm

328023 10,5x8x23,3



Rallador nuez moscada

Ref. cm

391000

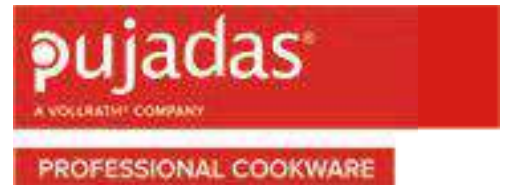

Sopletes



Ref. descripción

786600 Cabecal soplete profesional
727060 Recambio gas profesional



Ref. descripción

704500 Soplete gourmet
727020 Recambio gas butano

Pinzas



Marca: Lacor

Pinza Multiusos Luxe

Ref. \longleftrightarrow mm

62334 250



Marca: Lacor

Pinza Repostería

Ref. \longleftrightarrow mm

62317 200

Pinza Multiusos

Marca: APS

Ref. descripción \longleftrightarrow mm

| | | |
|-------|-----------------|-----|
| 00685 | Pinza ensalada | 250 |
| 00688 | Pinza multiusos | 250 |
| 00687 | Pinza Pan | 250 |
| 00686 | Pinza bollería | 250 |



Marca: Lacor

Pinza Servir

Ref. \longleftrightarrow mm

68009 240



Marca: Lacor

Pinza Pasta Luxe

Ref. \longleftrightarrow mm

62981 200

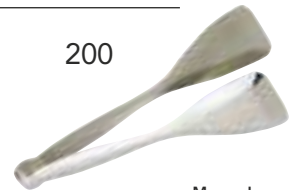

Marca: Lacor

Pinza Pan

Ref. \longleftrightarrow mm

62982 230



Marca: Lacor

Pinza Hielo

Ref. \longleftrightarrow mm

62306 185



Marca: Lacor

Pinza Repostería Anillas

Ref. \longleftrightarrow mm

68008 160

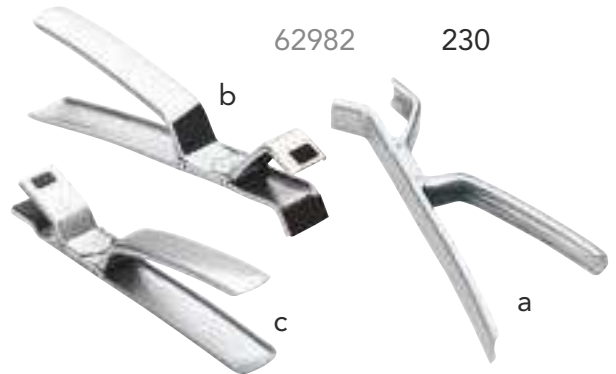

Pinza Multiusos

Marca: APS

Ref. descripción \longleftrightarrow mm

| | | | |
|-------|------------------------|-----|---|
| 62989 | Pinza horno | 200 | a |
| 62998 | Pinza horno c/silicona | 200 | b |
| 00686 | Pinza platos | 250 | c |



Pinza Karu

Marca: Lacor

Ref. \longleftrightarrow mm Ref. \longleftrightarrow mm

| | | | | |
|-------|-----|-------|-----|----------|
| 63060 | 240 | 63070 | 300 | Rojo |
| 63061 | 240 | 63071 | 300 | Negro |
| 63062 | 240 | 63072 | 300 | Azul |
| 63063 | 240 | 63073 | 300 | Amarillo |
| 63064 | 240 | 63074 | 300 | Verde |
| 63065 | 240 | 63075 | 300 | Marrón |



Pinza Jumbo

| Ref. | <—> mm |
|-------|--------|
| 62924 | 240 |
| 62930 | 300 |
| 62940 | 400 |



Pinza Jumbo Nylon

| Ref. | <—> mm |
|-------|--------|
| 62926 | 240 |
| 62929 | 300 |
| 62939 | 400 |



Pinza Servir

| Ref. | <—> mm |
|-------|--------|
| 62353 | 240 |



Pinza Silicona

| Ref. | <—> mm | |
|-------|--------|---------|
| 64432 | 180 | Naranja |
| 64433 | 180 | Rojo |
| 64436 | 180 | Azul |
| 64437 | 180 | Verde |
| 64439 | 180 | Morada |



Pinza Grill

| Ref. | <—> mm |
|-------|--------|
| 62933 | 300 |



Pinza Emplatar

| Ref. | <—> mm |
|-------|--------|
| 62956 | 210 |
| 62955 | 155 |



Pinza Emplatar Precisión

| Ref. | <—> mm |
|-------|--------|
| 62821 | 210 |
| 62954 | 160 |



Bandejas Horno



Bandeja hierro borde recto

| Ref. | <—> mm | Alt mm |
|--------|---------|--------|
| 532053 | 530x325 | 20 |
| 536240 | 400x300 | 20 |
| 536260 | 600x400 | 20 |



Bandeja hierro borde redondo

| Ref. | <—> mm | Alt mm |
|--------|---------|--------|
| 532132 | 325x265 | 10 |
| 532153 | 530x325 | 10 |
| 532165 | 650x530 | 10 |
| 536340 | 400x300 | 10 |
| 536360 | 600x400 | 10 |



Rejilla Acero

| Ref. | <—> mm | Alt mm |
|---------|---------|--------|
| 333053N | 530x325 | |
| 333060N | 600x400 | |
| 333065N | 650x530 | |



Bandeja aluminio borde recto

| Ref. | <—> mm | Alt mm |
|--------|---------|--------|
| 736260 | 600x400 | 20 |



Bandeja aluminio borde redondo

| Ref. | <—> mm | Alt mm |
|--------|---------|--------|
| 736040 | 400x300 | 10 |
| 736053 | 530x325 | 10 |
| 736060 | 600x400 | 10 |

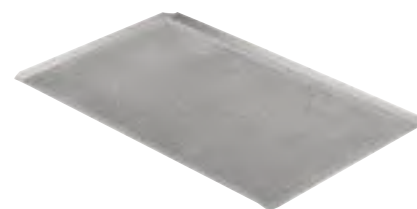

Bandeja aluminio perforada

| Ref. | <—> mm | Alt mm |
|--------|---------|--------|
| 736740 | 400x300 | 10 |
| 736753 | 530x325 | 10 |
| 736760 | 600x400 | 10 |



Bandeja acero borde recto

| Ref. | <—> mm | Alt mm |
|--------|---------|--------|
| 332032 | 325x265 | 7 |
| 332053 | 530x325 | 15 |
| 332065 | 650x530 | 15 |
| 336040 | 400x300 | 15 |
| 336060 | 600x400 | 17 |



Bandeja acero borde redondo

| Ref. | <—> mm | Alt mm |
|--------|---------|--------|
| 332153 | 530x325 | 10 |
| 332165 | 650x530 | 10 |
| 336140 | 400x300 | 10 |
| 336160 | 600x400 | 10 |



Taete Silicona

| Ref. | <—> mm |
|---------|---------|
| 493140N | 400x300 |
| 493158N | 600x400 |
| 493151N | 530x325 |

Preparación



Caldero cónico c/asas

| Ref. | ←→ cm | lts |
|-------|-------------|-------|
| 50828 | 28 Øx13,2 h | 5,00 |
| 50832 | 32 Øx14,5 h | 7,00 |
| 50836 | 36 Øx16,0 h | 11,00 |
| 50840 | 40 Øx18,0 h | 15,00 |
| 50845 | 45 Øx20,0 h | 22,00 |
| 50850 | 50 Øx21,0 h | 30,00 |



Caldero semiesférico s/asas

| Ref. | ←→ cm | lts |
|--------|-------------|-------|
| 50323S | 22 Øx11,0 h | 2,70 |
| 50327S | 26 Øx13,0 h | 4,00 |
| 50333S | 32 Øx17,0 h | 9,50 |
| 50337S | 36 Øx18,0 h | 12,00 |
| 50341S | 40 Øx21,0 h | 14,50 |



Caldero semiesférico c/asas

| Ref. | ←→ cm | lts |
|-------|-------------|-------|
| 50323 | 22 Øx11,0 h | 2,70 |
| 50327 | 26 Øx13,0 h | 4,00 |
| 50333 | 32 Øx17,0 h | 9,50 |
| 50337 | 36 Øx18,0 h | 12,00 |
| 50341 | 40 Øx21,0 h | 14,50 |



Fuente cónica honda

| Ref. | ←→ cm | lts |
|-------|-------------|-------|
| 60013 | 13 Øx6,1 h | 0,55 |
| 60016 | 16 Øx9,1 h | 1,00 |
| 60020 | 20 Øx11,7 h | 2,12 |
| 60024 | 24 Øx12,6 h | 3,50 |
| 60028 | 28 Øx13,4 h | 5,25 |
| 60032 | 32 Øx15,0 h | 7,65 |
| 60036 | 36 Øx16,0 h | 11,00 |
| 60040 | 40 Øx18,0 h | 15,00 |



Soporte caldero semiesférico

| Ref. |
|-------|
| 50300 |



Bol cónico inox 18% Cr

| Ref. | ←→ cm | lts |
|-------|-------------|------|
| 14016 | 16 Øx6,5 h | 0,90 |
| 14019 | 20 Øx7,5 h | 1,40 |
| 14025 | 24 Øx9,0 h | 2,50 |
| 14029 | 30 Øx11,0 h | 4,30 |
| 14033 | 34 Øx13,5 h | 7,50 |



Guantes



Guante algodón+silicona

| Ref. | ←→ cm |
|-------|-------|
| 61033 | 33,0 |



Guante algodón aluminado

| Ref. | ←→ cm |
|-------|-------|
| 61024 | 24,0 |
| 61030 | 30,0 |
| 61036 | 36,0 |



Guante silicona

| Ref. | ←→ cm |
|-------|-------|
| 60010 | 29,0 |
| 60011 | 42,0 |

Aros-Moldes

Aro redondo



Marca: Lacor

| Ø cm | 3,5 cm h | 4 cm h | 4,5 cm h | 6 cm h |
|------|----------|--------|----------|--------|
| 6 | | 68406 | 68506 | |
| 7 | | | | 86807 |
| 7,5 | | 68407 | | |
| 8 | 68308 | 68408 | 68508 | 68608 |
| 9 | | | 68509 | 68609 |
| 10 | 68310 | 68410 | 68510 | 68610 |
| 12 | | 68412 | 68512 | 68612 |
| 14 | | 68414 | 68514 | 68614 |
| 16 | | 68416 | 68516 | 68616 |
| 18 | | 68418 | 68518 | 68618 |
| 20 | | 68420 | 68520 | 68620 |
| 22 | | 68422 | 68522 | 68622 |
| 24 | | 68424 | 68524 | 68624 |
| 26 | | | 68526 | 68626 |
| 28 | | | | 68628 |



Marca: Lacor

Molde cuadrado

| Ref. | <—> cm |
|-------|---------|
| 68460 | 6x6x4 |
| 68480 | 8x8x4 |
| 68411 | 10x10x4 |
| 68441 | 14x14x4 |
| 68240 | 20x20x4 |



Marca: De Buyer

Molde triangular

| Ref. | <—> cm |
|--------|----------|
| 393716 | 20x4,5 h |
| 393720 | 25x4,5 h |
| 393724 | 30x4,5 h |

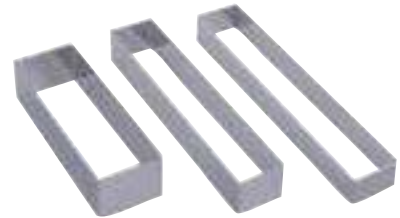

Marca: De Buyer

Molde rectangular

| Ref. | <—> cm |
|--------|--------------|
| 394305 | 5x2,5x2,5 h |
| 394308 | 8x2,5x2,5 h |
| 394310 | 10x2,5x2,5 h |
| 394312 | 12x4x3 h |
| 394313 | 12x4x4 h |
| 394216 | 16x3x2,5 h |
| 394118 | 18x3x2 h |



Marca: De Buyer

Molde piramidal

| Ref. | <—> cm |
|---------|---------------|
| 302306N | 6x6x4 h |
| 302307N | 7,5x7,5x5,2 h |
| 302309N | 9x9x6 h |
| 302312N | 12x12x8 h |
| 302315N | 15x15x10 h |
| 302317N | 17x17x12 h |
| 302319N | 19x19x13 h |



Marca: De Buyer

Molde semiesférico

| Ref. | <—> cm |
|---------|------------|
| 313304N | 4 Øx2 h |
| 313300N | 6 Øx2,7 h |
| 313307N | 7 Øx3,5 h |
| 313308N | 8 Øx4 h |
| 313309N | 9 Øx4,2 h |
| 313310N | 10 Øx4,8 h |
| 313312N | 12 Øx5,9 h |
| 313314N | 14 Øx6,7 h |
| 313316N | 16 Øx8 h |
| 313318N | 18 Øx8,7 h |
| 313320N | 20 Øx10 h |

Medida



Marca: Lacor

Jarra medidora

| Ref. | <—> cm | lts |
|-------|-------------|------|
| 62750 | 17 Øx22,5 h | 5,00 |



Marca: Lacor

Jarra medidora cónica

| Ref. | lts |
|-------|------|
| 67010 | 1,00 |



Marca: Lacor

Juego cucharas medida

| Ref. | ml |
|-------|------------------|
| 67001 | 0,62/1,25/2/5/15 |



Marca: Lacor

Juego cazos medida

| Ref. | ml |
|-------|---------------|
| 67007 | 60/80/125/250 |



Marca: Lacor

Librador inox

| Ref. | <—> cm | ml |
|-------|--------|-----|
| 67012 | 19,0 | 60 |
| 67013 | 21,5 | 110 |
| 67014 | 24,0 | 200 |
| 67016 | 25,5 | 260 |
| 67017 | 29,0 | 360 |
| 67018 | 31,0 | 470 |
| 67019 | 35,0 | 640 |
| 67020 | 38,0 | 860 |



Marca: Lacor

Librador PC

| Ref. | ml |
|-------|------|
| 67021 | 170 |
| 67022 | 900 |
| 67023 | 1800 |

Espátulas-pinceles



Marca: Lacor

Espátula silicona mango inox

| Ref. | cm |
|-------|----|
| 67421 | 20 |
| 67427 | 26 |
| 67433 | 32 |



Marca: Lacor

Espátula silicona

| Ref. | cm |
|-------|----|
| 64460 | 25 |
| 64461 | 35 |



Marca: Lacor

Espátula-cuchara silicona

| Ref. | cm |
|-------|----|
| 64450 | 25 |
| 64451 | 35 |



Marca: Lacor

Pincel silicona inox 18/10

| Ref. | cm |
|-------|----|
| 64418 | 22 |
| 64422 | 24 |
| 64438 | 24 |



Marca: Lacor

Pincel silicona mango inox

| Ref. | cm |
|-------|------|
| 64425 | 24x6 |
| 64431 | 24x8 |

Mangas-decoración



Marca: De Buyer

Manga pastelera poliuretano

Ref. **<—> mm**

| | |
|--------|-----|
| 434735 | 350 |
| 434745 | 450 |
| 434750 | 500 |



Marca: De Buyer

Soporte mangas

Ref. **<—> mm**

| | |
|---------|-----------|
| 434710N | 195x230 h |
|---------|-----------|



Marca: Lacor

Manga pastelera nylon

Ref. **<—> mm**

| | |
|-------|----|
| 68930 | 30 |
| 68935 | 35 |
| 68940 | 40 |
| 68945 | 45 |
| 68950 | 50 |
| 68955 | 55 |
| 68960 | 60 |
| 68965 | 65 |
| 68970 | 70 |

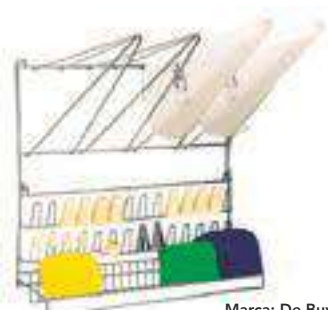

Marca: De Buyer

Soporte mangas mural

Ref. **<—> mm**

| | |
|---------|---------|
| 434720N | 500x500 |
|---------|---------|



Marca: Ibili

Set boquillas policarbonato 23 ud

Ref. 783800



Marca: Lacor

Manga pastelera desechable

- Galga 280
- Paquete 100 ud

Ref. **<—> mm**

| | |
|-------|----|
| 68939 | 40 |
| 68954 | 55 |
| 68964 | 65 |



Marca: Ibili

Set boquillas rusas

Ref. 252000



Marca: Ibili

Set boquillas rusas XL

Ref. 252001



Corte



Mandolina kobra con pulsador

Ref. <—> mm

201101 365x122x80

Marca: De Buyer



Marca: Tellier

Rasqueta plástico flexible

Ref. <—> mm

485800N 15x11x0,2

Marca: De Buyer

Mandolina japonesa N4291

• ABS

<—> cm

34,5x14,5x2,3

Extractor manual frutas

Ref. <—> mm

261201 12 Ø
261202 20 Ø
261203 30 Ø

Marca: De Buyer



Marca: Tellier

Sacabocado turn up

Ref. <—> mm

N7103 30 Ø
N7101 40 Ø
N7102 50 Ø



Marca: De Buyer

Rodillo cortapasta extensible

Ref. <—> mm

478100N 5,5 Ø
478102 10,0 Ø

Sifones-cedazos



Marca: Lacor

Sifón crema inox

| Ref. | Its |
|-------|------|
| 68404 | 0,50 |
| 68405 | 1,00 |



Marca: Lacor

Cedazo acero

| Ø cm | Paso 50 | Paso 35 | Paso 25 | Paso 20 |
|------|---------|---------|---------|---------|
| 12 | 68052 | | | |
| 16 | 68056 | | | |
| 18 | 68058 | | | |
| 20 | 68050 | 68350 | 68250 | |
| 26 | 68057 | 68357 | 68252 | 68026 |
| 30 | 68053 | 68351 | 68253 | 68023 |
| 40 | 68054 | 68354 | 68254 | 68024 |



Marca: Lacor

Carga sifón N20

| Ref. | Pack |
|-------|------|
| 68402 | 10 |
| 68403 | 24 |



Marca: Lacor

Cribador harina

| Ref. | Ø |
|-------|----|
| 67011 | 10 |
| 67015 | 12 |

Especiero 7 cm Ø x 11 cm h

| Ref. | Descripción |
|-------|-----------------------------|
| 62906 | Especiero agujeros pequeños |
| 62905 | Especiero agujeros grandes |
| 62904 | Especiero agujeros queso |
| 62907 | Especiero hierbas |
| 62903 | Especiero malla fina |



Marca: Lacor

Rodillos



Marca: Lacor

Rodillo inox 18/10

| Ref. | ←→ mm |
|-------|---------|
| 67140 | 400/200 |
| 67148 | 480/250 |
| 67156 | 560/330 |



Marca: Lacor

Rodillo antiadherente

| Ref. | ←→ mm |
|-------|---------|
| 67141 | 400/200 |
| 67149 | 480/250 |



Marca: Lacor

Rodillo madera haya

| Ref. | ←→ mm |
|-------|---------|
| 68153 | 500/300 |
| 68154 | 600/400 |

Medición



Marca: Lacor

Báscula

| Ref. | Kg |
|------|----|
|------|----|

| | |
|-------|-------------|
| 61703 | 5 kg / 1 gr |
|-------|-------------|



Marca: Lacor

Báscula precisión

| Ref. | gr |
|------|----|
|------|----|

| | |
|-------|-----------|
| 61709 | 650 / 0,1 |
|-------|-----------|



Marca: Lacor

Termómetro laser

| Ref. | T |
|------|---|
|------|---|

| | |
|-------|---------------|
| 62457 | -80°C / 400°C |
|-------|---------------|



Marca: Lacor

Termómetro horno

| Ref. | T |
|------|---|
|------|---|

| | |
|-------|--------------|
| 62454 | 50°C / 300°C |
|-------|--------------|



Marca: Lacor

Termómetro refrigerador

| Ref. | T |
|------|---|
|------|---|

| | |
|-------|--------------|
| 62450 | -30°C / 30°C |
|-------|--------------|



Marca: Lacor

Termómetro carne

| Ref. | T |
|------|---|
|------|---|

| | |
|-------|--------------|
| 62452 | -54°C / 88°C |
|-------|--------------|



Marca: Lacor

Termómetro digital c/sonda

| Ref. | T |
|------|---|
|------|---|

| | |
|-------|-------------|
| 62498 | 0°C / 300°C |
|-------|-------------|



Marca: De Buyer

Termómetro digital

| Ref. | T |
|------|---|
|------|---|

| | |
|--------|---------------|
| 488100 | -50°C / 200°C |
|--------|---------------|

Aceiteras



Marca: Ibili

Aceitera

| Ref. | Its |
|------|-----|
|------|-----|

| | |
|--------|------|
| 709703 | 0,30 |
| 709705 | 0,50 |
| 709710 | 1,00 |



Marca: Lacor

Aceitera cónica

| Ref. | Its |
|------|-----|
|------|-----|

| | |
|-------|------|
| 62525 | 0,25 |
| 62555 | 0,50 |
| 62551 | 1,00 |

Moldes silicona black

- Silicona 60x40 cm.
- 60°C / +230°C

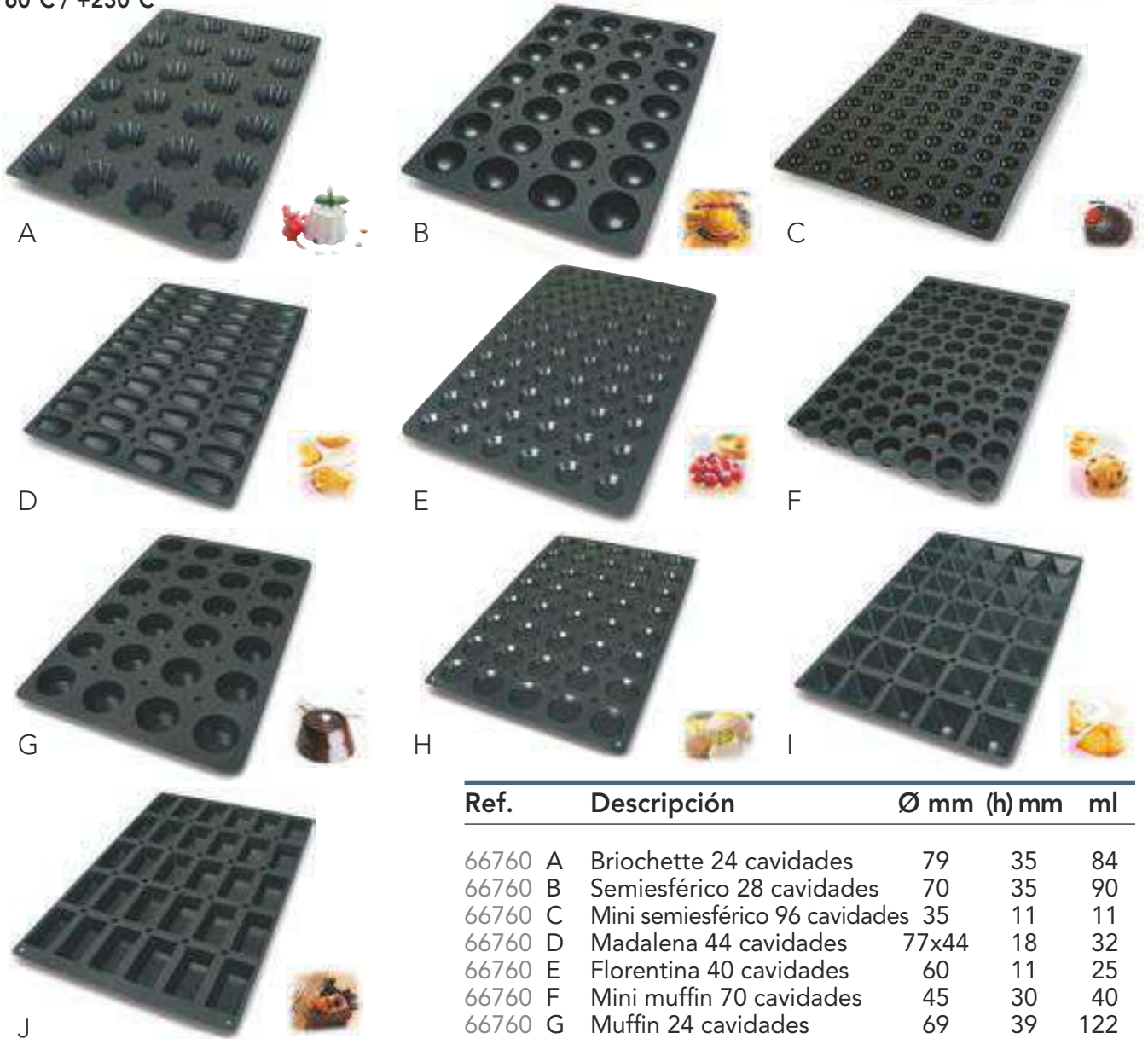

| Ref. | Descripción | Ø mm | (h) mm | ml |
|---------|--------------------------------|-------|--------|-----|
| 66760 A | Briochette 24 cavidades | 79 | 35 | 84 |
| 66760 B | Semiesférico 28 cavidades | 70 | 35 | 90 |
| 66760 C | Mini semiesférico 96 cavidades | 35 | 11 | 11 |
| 66760 D | Madalena 44 cavidades | 77x44 | 18 | 32 |
| 66760 E | Florentina 40 cavidades | 60 | 11 | 25 |
| 66760 F | Mini muffin 70 cavidades | 45 | 30 | 40 |
| 66760 G | Muffin 24 cavidades | 69 | 39 | 122 |
| 66760 H | Tartaleta 60 cavidades | 44 | 10 | 10 |
| 66760 I | Piramide 35 cavidades | 65x65 | 35 | 61 |
| 66760 J | Mini cake 30 cavidades | 99x49 | 30 | 110 |

Moldes silicona

- -40°C / +260°C
- Con anillo de refuerzo



Molde cake

| Ref. | <—> mm |
|-------|------------|
| 66733 | 240x100x65 |
| 66742 | 260x100x70 |



Molde savarin bajo

| Ref. | <—> mm |
|-------|--------------|
| 66734 | 230 Ø x 60 h |



Molde savarin alto

| Ref. | <—> mm |
|-------|---------------|
| 66735 | 230 Ø x 105 h |



Molde redondo

| Ref. | <—> mm |
|-------|--------------|
| 66737 | 240 Ø x 45 h |
| 66738 | 260 Ø x 45 h |



Molde tarta

| Ref. | <—> mm |
|-------|--------------|
| 66739 | 290 Ø x 35 h |

Moldes silicona pastryflex



- Silicona 175x300 mm.
- -40°C / +260°C

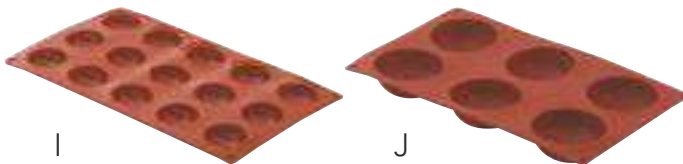
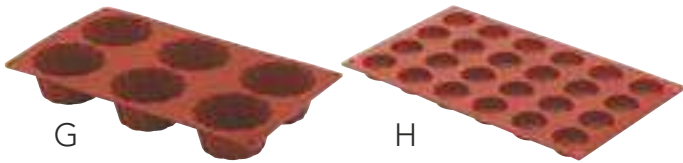
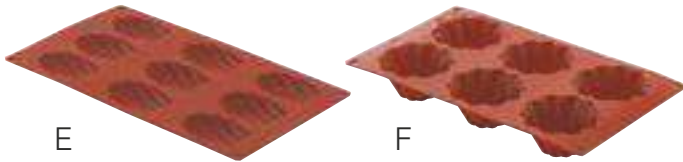
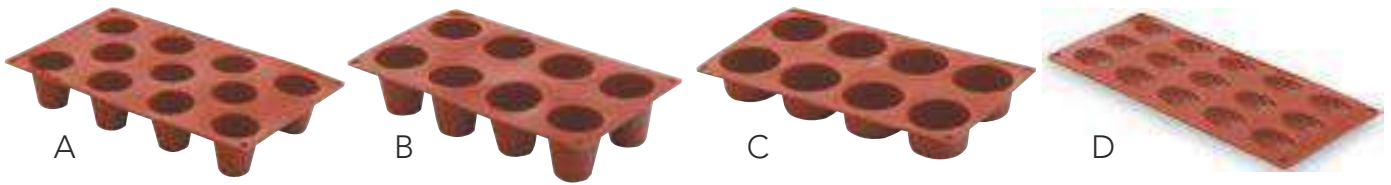

| Ref. | Descripción | Ø mm | (h) mm |
|-------|---------------------------|-------|--------|
| 66812 | A Cilindro 11 cavidades | 45 | 48 |
| 66813 | B Cilindro 8 cavidades | 55 | 60 |
| 66807 | C Cilindro 6 cavidades | 60 | 35 |
| 66816 | D Madalena 15 cavidades | 42x30 | 11,5 |
| 66817 | E Madalena 9 cavidades | 78x45 | 17 |
| 66819 | F Briochette 6 cavidades | 103 | 20 |
| 66820 | G Briochette 6 cavidades | 79 | 30 |
| 66800 | H Semiesfera 24 cavidades | 30 | 17 |
| 66801 | I Semiesfera 15 cavidades | 40 | 20 |
| 66802 | J Semiesfera 6 cavidades | 70 | 35 |
| 66821 | K Piramide 15 cavidades | 36 | 22 |
| 66822 | L Piramide 6 cavidades | 71 | 41 |

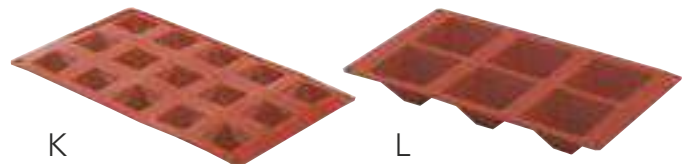

| Ref. | Descripción | Ø mm | (h) mm |
|-------|-------------------------------|-------|--------|
| 66823 | A Oval 16 cavidades | 53x33 | 20 |
| 66805 | B Muffin 6 cavidades | 70 | 40 |
| 66804 | C Mini muffin 11 cavidades | 50 | 28 |
| 66824 | D Corazón 8 cavidades | 65x60 | 35 |
| 66825 | E Rectángulo 20 cavidades | 49x26 | 11 |
| 66826 | F Cake 12 cavidades | 80x30 | 30 |
| 66827 | G Petit four 15 cavidades | 40 | 20 |
| 66828 | H Pomponette 24 cavidades | 34 | 16 |
| 66808 | I Mini savarin 15 cavidades | 41 | 12 |
| 66830 | J Base esponjosa 3 cavidades | 103 | 20 |
| 66844 | K Mini bordelais 18 cavidades | 25 | 30 |

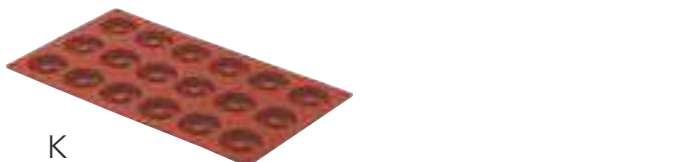
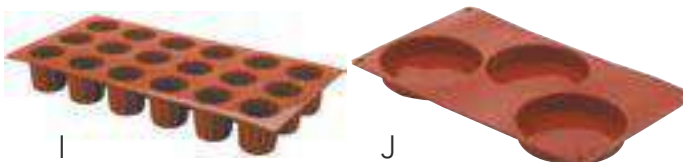
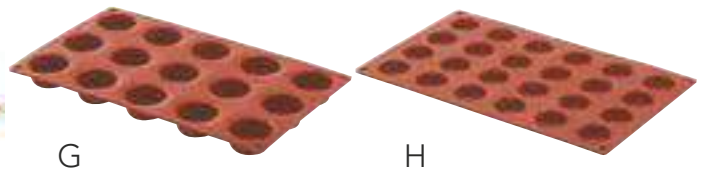
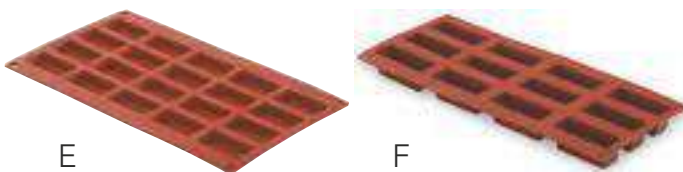
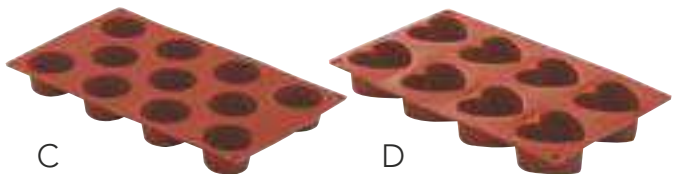
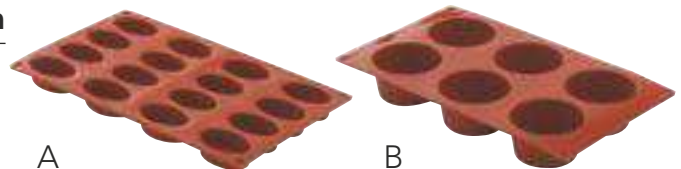

Moldes



Molde cake antiadherente

Ref. <—> mm

68714 240Ø x 70 h
68716 260Ø x 70 h
68718 280Ø x 70 h



Molde savarin antiadherente

Ref. <—> mm

68724 240Ø x 65 h
68862 260Ø x 65 h
68863 280Ø x 65 h



Molde rizado antiadherente

Ref. <—> mm

68842 240 Ø
68882 280 Ø
68823 320 Ø



Tartaleta rizada

Ref. <—> mm

68104 40 Ø
68105 50 Ø
68109 90 Ø
68110 100 Ø
68112 120 Ø
68113 140 Ø



Madalena rizada

Ref. <—> mm

68015 50 Ø
68016 60 Ø
68019 90 Ø



Tartaleta lisa

Ref. <—> mm

68119 90 Ø



Cornete

Ref. <—> mm

68936 120



Molde cake inox

Ref. <—> mm

65925 250x120x85
65930 300x120x85
65935 350x120x85



Molde cake antiadherente

Ref. <—> mm

68725 250x120x85
68730 300x120x85
68735 350x120x85



Flanero aluminio

Ref. <—> mm

60006 240 Ø x 65 h
60007 70 Ø x 50 h
60008 80 Ø x 53 h



Flanero inox

Ref. <—> mm

12406 60 Ø x 49 h
12407 70 Ø x 49 h
12408 80 Ø x 50 h

Marco rectangular inox

Ref. <—> mm

68043 300x400x30
68048 310x480x30
68060 400x600x30
68041 300x400x50
68049 310x480x50
68061 400x600x50



Bandeja rectangular inox

Ref. <—> mm

68030 300x400x10
68031 310x480x10
68040 400x600x10

Máquinas



Corta-patatas

| Ref. | Descripción |
|------|----------------------------|
| CX06 | Cuchilla y empujador 6 mm |
| CX08 | Cuchilla y empujador 8 mm |
| CX10 | Cuchilla y empujador 10 mm |
| CX13 | Cuchilla y empujador 13 mm |



Cortador tomates secciones

| Ref. | Descripción |
|--------|--------------|
| CAX104 | 4 Secciones |
| CAX106 | 6 Secciones |
| CAX108 | 8 Secciones |
| CAX112 | 12 Secciones |



Corta-patatas con pié

| Ref. | Descripción |
|------|----------------------------|
| CP06 | Cuchilla y empujador 6 mm |
| CP08 | Cuchilla y empujador 8 mm |
| CP10 | Cuchilla y empujador 10 mm |
| CP13 | Cuchilla y empujador 13 mm |



Cortadora tomates CTX55

- 48X20X32 cm
- Espesor rodaja 5,5 mm



Cortadora tomates CTXM55

- 30X14X18 cm
- Espesor rodaja 5,5 mm



Pelador manzanas N4230

- 39X12,5X21 cm
- Espesor rodaja 4 mm



Multi cortadora MCX

- Corte en rodajas: 5,5 mm
- Corte en sectores: 6/8 ud
- Corte en bastoncillos: 8/10 mm



Pelador-descorazonador piña EA

- Diámetro: 74/89/95/102 mm
- 45x39x72 cm



Cortador lechuga CSA

- 39X42X120 cm



Línea antialérgica

NUEVO



Prepare y sirva comida que no contengan alérgenos. Determine los utensilios que va a usar para preparar y servir comidas que no contengan alérgenos, color morado para una rápida identificación por parte de los empleados y clientes.



Gastronorm polipropileno

| Ref. | tipo | Hmm | lts. |
|----------|------|-----|-------|
| P111.5P6 | 1/1 | 150 | 19,60 |
| P121.5P6 | 1/2 | 150 | 8,70 |
| P131.5P6 | 1/3 | 150 | 5,00 |
| P161.5P6 | 1/6 | 150 | 5,00 |



Tapa Polinorm

| Ref. | Mod. | U. |
|----------|------|----|
| P110.0P6 | 1/1 | 30 |
| P120.0P6 | 1/2 | 60 |
| P130.0P6 | 1/3 | 30 |
| P160.0P6 | 1/6 | 60 |



Caja de almacenamiento

| Ref. | ←→ | L cm | U |
|------------|----|----------------|---|
| 1527-C80cj | | 38,1x50,8x17,8 | 6 |
| 1500-C80tp | | 39,7x57,2x6,4 | 6 |
| 1522-C80tp | | 10,3x54,9x2,5 | 6 |



Bol servicio doble redondo

| Ref. | cms | lts. | U |
|---------|-----------|------|---|
| 4658765 | 14,4x7.6 | 0,7 | 6 |
| 4659065 | 18,4x10,3 | 1,6 | 6 |
| 4659165 | 24,1x12.9 | 3,2 | 6 |
| 4659265 | 30x16,5 | 6,6 | 3 |
| 4656965 | 35x17.5 | 9,6 | 2 |



Bol servicio doble cuadrado

| Ref. | cms | lts. | U |
|---------|-----------|------|---|
| 4761965 | 14,4x7.6 | 0,7 | 6 |
| 4763265 | 18,4x10,3 | 1,6 | 6 |
| 4763465 | 24,1x12.9 | 3,2 | 6 |
| 4763565 | 30x16,5 | 6,6 | 3 |
| 4656965 | 35x17.5 | 9,6 | 2 |



Tabla de corte

| Ref. | L cm | U |
|---------|---------------|---|
| 5200080 | 30,5x45,7x1,3 | 6 |



Accesorios

| Ref. | ←→ | cms |
|------------------|----|-------------|
| Batidor 47003 | | 12 |
| Cacillo 4980280 | | 25 (60ml) |
| Pinzas 4780980 | | 24 |
| Cuchara 6414080 | | 35 |
| Espátula 4808880 | | 42 (21x7,5) |



Sartén antiadherente

| Ref. | Ø cm | Hcm | U |
|---------|------|-----|---|
| T400780 | 18 | 4,0 | 6 |
| T400880 | 20 | 5,0 | 6 |
| T401080 | 25 | 5,0 | 6 |
| T401280 | 30 | 5,5 | 2 |

CAFETERÍA Y SERVICIOS DE MESA

*Cafeteria and Table Service • Service de Cafétéria
Caffetteria e Tavolo di Servizio • Cafeteria und TISCH*



Cafetería

Classic



| Código | Descripción | Capacidad (lt) |
|--------|-------------|----------------|
|--------|-------------|----------------|

| | | |
|-------|----------|------|
| 62215 | Lechera | 0,15 |
| 62225 | Lechera | 0,25 |
| 62235 | Lechera | 0,35 |
| 62260 | Lechera | 0,60 |
| 62210 | Lechera | 1,00 |
| 62216 | Lechera | 1,50 |
| 62220 | Lechera | 2,00 |
| 62023 | Tetera | 0,23 |
| 62035 | Tetera | 0,35 |
| 62060 | Tetera | 0,60 |
| 62010 | Tetera | 1,00 |
| 62135 | Cafetera | 0,35 |
| 62160 | Cafetera | 0,60 |
| 62110 | Cafetera | 1,00 |
| 62115 | Cafetera | 1,50 |
| 62120 | Cafetera | 2,00 |



| Código | Descripción | Capacidad (lt) |
|--------|-------------|----------------|
|--------|-------------|----------------|

| | | |
|--------|----------|------|
| 882015 | Lechera | 0,15 |
| 882035 | Lechera | 0,35 |
| 882050 | Lechera | 0,50 |
| 882100 | Lechera | 1,00 |
| 882175 | Lechera | 1,75 |
| 880020 | Tetera | 0,20 |
| 880035 | Tetera | 0,35 |
| 880050 | Tetera | 0,50 |
| 880100 | Tetera | 1,00 |
| 880175 | Tetera | 1,75 |
| 881035 | Cafetera | 0,35 |
| 881050 | Cafetera | 0,50 |
| 881100 | Cafetera | 1,00 |
| 881175 | Cafetera | 1,75 |

Cosmo



Bella

| Código | Descripción | Capacidad (lt) |
|--------|-------------|----------------|
|--------|-------------|----------------|

| | | |
|--------|----------|------|
| 020901 | Lechera | 0,15 |
| 020902 | Lechera | 0,25 |
| 020903 | Lechera | 0,50 |
| 020904 | Lechera | 1,00 |
| 020401 | Tetera | 1,15 |
| 020402 | Tetera | 0,25 |
| 020403 | Tetera | 0,50 |
| 020215 | Cafetera | 0,25 |
| 020216 | Cafetera | 0,50 |
| 020217 | Cafetera | 1,00 |





Latina



| Código | Descripción | Capacidad (lt) |
|--------|-------------------|----------------|
| 010901 | Lechera | 0,15 |
| 010902 | Lechera | 0,25 |
| 010903 | Lechera | 0,50 |
| 010904 | Lechera | 1,00 |
| 010905 | Lechera | 1,50 |
| 010906 | Lechera | 2,25 |
| 011601 | Tetera con filtro | 0,12 |
| 011602 | Tetera con filtro | 0,25 |
| 011603 | Tetera con filtro | 0,50 |
| 011607 | Tetera sin filtro | 0,12 |
| 011608 | Tetera con filtro | 0,25 |
| 011609 | Tetera con filtro | 0,50 |
| 010407 | Cafetera | 0,25 |
| 010408 | Cafetera | 0,50 |
| 010409 | Cafetera | 1,00 |
| 010410 | Cafetera | 1,50 |

Barista



| Código | lt |
|--------|----|
|--------|----|

| | |
|-------|------|
| 90125 | 0,25 |
| 90135 | 0,35 |
| 90150 | 0,50 |
| 90175 | 0,75 |
| 90110 | 1,00 |
| 90115 | 1,50 |



Lechera Negra

| Código | lt |
|--------|----|
|--------|----|

| | |
|------|------|
| 2535 | 0,35 |
| 2550 | 0,50 |
| 2575 | 0,75 |



Lechera Blanca

| Código | lt |
|--------|----|
|--------|----|

| | |
|------|------|
| 2435 | 0,35 |
| 2450 | 0,50 |
| 2475 | 0,75 |



Lechera Verde

| Código | lt |
|--------|----|
|--------|----|

| | |
|------|------|
| 2835 | 0,35 |
| 2850 | 0,50 |
| 2875 | 0,75 |



Lechera Roja

| Código | lt |
|--------|----|
|--------|----|

| | |
|------|------|
| 2735 | 0,35 |
| 2750 | 0,50 |
| 2775 | 0,75 |



Lechera Naranja

| Código | lt |
|--------|----|
|--------|----|

| | |
|------|------|
| 2635 | 0,35 |
| 2650 | 0,50 |
| 2675 | 0,75 |

Teteras



Tetera Stove

| Código | lt |
|--------|------|
| 621702 | 0,20 |
| 621704 | 0,45 |
| 621708 | 0,80 |



Tetera Cristal

| Código | lt |
|--------|------|
| 622303 | 0,35 |
| 622306 | 0,60 |
| 622309 | 0,95 |



Tetera Hierro Negra

| Código | lt |
|--------|------|
| 620003 | 0,30 |
| 620007 | 0,72 |
| 620012 | 1,20 |



Tetera Hierro Hanoi

| Código | lt |
|--------|------|
| 622603 | 0,30 |



Tetera Inox Tokio

| Código | lt |
|--------|------|
| 622104 | 0,45 |



Tetera Hierro Nepal

| Código | lt |
|--------|------|
| 622805 | 0,50 |



| Código | Descripción | Capacidad (lt) |
|--------|---------------|----------------|
| 62716 | Jarra s/retén | 1,5 - 12x16 cm |
| 62721 | Jarra s/retén | 2,0 - 12x23 cm |
| 62726 | Jarra s/retén | 2,5 - 12x26 cm |
| 62715 | Jarra c/retén | 1,5 - 12x16 cm |
| 62720 | Jarra c/retén | 2,0 - 12x23 cm |
| 62725 | Jarra c/retén | 2,5 - 12x26 cm |



Jarra Termo Luxe

| Código | lt |
|--------|------|
| 63360 | 0,60 |
| 63310 | 1,00 |
| 63315 | 1,50 |
| 63320 | 2,00 |



Servidor Termo

| Código | lt |
|--------|------|
| 62481 | 1,00 |
| 62482 | 1,20 |
| 62485 | 1,50 |
| 62486 | 2,00 |

Jarra Termo

| Código | lt |
|--------|------|
| 63360 | 0,60 |
| 63310 | 1,00 |
| 63315 | 1,50 |
| 63320 | 2,00 |



Servidor Termo D/Pared

| Código | Descripción | Capacidad (lt) |
|--------|-------------|----------------|
| 62483 | Blanco | 1,00 |
| 62484 | Negro | 1,00 |



Cafetera Pava

| Código | lt |
|--------|------|
| 68215 | 1,50 |
| 68225 | 2,50 |
| 68235 | 3,50 |
| 68205 | 5,00 |



Hervidor

| Código | lt |
|--------|------|
| 68619 | 2,00 |
| 68627 | 2,50 |
| 68629 | 3,00 |
| 68639 | 4,00 |
| 68649 | 5,00 |



Air Pot

| Código | lt |
|--------|------|
| 62472 | 2,50 |
| 62473 | 3,00 |
| 62475 | 3,50 |



Jarra Policarbonato

| Código | lt |
|--------|------|
| P600CW | 1,80 |
| P480CW | 1,40 |
| P320CW | 0,95 |



Jarra Oval Inox

| Código | lt |
|--------|------|
| 1750 | 1,00 |

Cubiteras

Serie Latina

Código Descripción Dimensiones (cm)

| | | |
|--------|-----------------|----------------|
| 010703 | Cubo 1 botella | 18 Ø - 4 lt |
| 010704 | Cubo 2 botellas | 22 Ø - 7 lt |
| 016205 | Portacubos | 69h |
| 010702 | Cubo hielo | 10 Ø - 0,75 lt |



Serie Bella

Código Descripción

| | |
|--------|-------------------------------|
| 021102 | Cubo 1 botella P/simple 4 Lt |
| 021103 | Cubo 1 botella P/doble 4 Lt |
| 021104 | Cubo 2 botellas P/simple 7 Lt |
| 021105 | Cubo 2 botellas P/doble 7 Lt |
| 026201 | Portacubos |



Bella

Latina



Pulido satinado

Cubo 1 botella anillas
Cod. 311F71
20 Ø x 19h cm

Cubo 1 botella pomos
Cod. 311F72
20 Ø x 19,5h cm



Portacubos 1 botella
Cod. 311004
18 Ø x 67,5h cm

Portacubos 2 botellas
Cod. 311020
22 Ø x 69,0h cm

Cubo 2 botellas anillas
Cod. 3212F51
20 Ø x 20h cm

Cubo 2 botellas pomos
Cod. 311F52
20 Ø x 20h cm



Soporte Mesa

Código (cm)

| | |
|-------|------|
| 62478 | 18 Ø |
| 62479 | 20 Ø |



Cubo Oval
Cod. 62338
30x20x20cm - 7,0 lt



Cubo Luxe

Código Descripción Dimensiones (cm)

| | | |
|-------|-----------------|----------------|
| 62315 | Cubo hielo | 14 Ø - 1,20 lt |
| 62320 | Cubo 1 botella | 20 Ø - 4,50 lt |
| 62322 | Cubo 2 botellas | 22 Ø - 5,50 lt |



Portacubos Luxe
Cod. 62300
20 Ø x 65h cm

Portacubos Oval
Cod. 62342
30x20 x 64h cm

Champaneras



Barreño liso o oval

| Código | Dimensiones (cm) |
|--------|------------------|
|--------|------------------|

| | |
|-------|------------------|
| 62271 | 43x30x20 - 20 lt |
| 62272 | 53x38x25 - 27 lt |
| 62273 | 61x43x28 - 32 lt |

Luxe

| Código | Dimensiones (cm) |
|--------|------------------|
|--------|------------------|

| | |
|-------|----------------|
| 62436 | 36 Ø - 11,5 lt |
| 62439 | 40 Ø - 15 lt |



Enfriador inox

| Código | Dimensiones (cm) |
|--------|------------------|
|--------|------------------|

| | |
|-------|-------------------|
| 62346 | 36 Ø x 20 - 13 lt |
| 62347 | 40 Ø x 20 - 16 lt |



Champanera redonda

Policarbonato + acero inox
Cod. 36049
44 Ø x 25h cm



Champanera oval

Acrílico
Cod. 36057
47 Ø x 28h cm



Champanera doble pared

Acero inox
Cod. 36044
44 Ø x 24h cm



Champanera acrílica

| Código | Descripción | Dimensiones (cm) |
|--------|-------------|------------------|
|--------|-------------|------------------|

| | | |
|-------|--------------|----------------------|
| 36078 | Transparente | 20 Ø x 25h - 3,50 lt |
| 36079 | Negra | 20 Ø x 25h - 3,50 lt |
| 36080 | Blanca | 20 Ø x 25h - 3,50 lt |



Champanera acrílica oval

| Código | Descripción | Dimensiones (cm) |
|--------|-------------|------------------|
|--------|-------------|------------------|

| | | |
|-------|-------------------|---------------------|
| 36048 | 2 botellas Blanca | 35x27x25,5 - 6,0 lt |
| 36052 | 1 botella Blanca | 27x20x21,0 - 3,0 lt |
| 36054 | 2 botellas Negra | 35x27x25,5 - 6,0 lt |
| 36053 | 1 botella Negra | 27x20x21,0 - 3,0 lt |



Vinagreras



Basic

| Código | Descripción |
|--------|---------------------|
| 62864 | Vinagrera Basic 2/p |
| 62862 | Vinagrera Basic 4/p |



Hiperlux

| Código | Descripción |
|--------|------------------------|
| 62463 | Vinagrera Hiperlux 2/p |
| 62465 | Vinagrera Hiperlux 4/p |



Soportes



| Código | Descripción | mm |
|--------|------------------|----|
| 3213 | Soporte 2 huecos | 57 |
| 3214 | Soporte 4 huecos | 57 |
| 3215 | Soporte 2 huecos | 65 |
| 3216 | Soporte 4 huecos | 65 |



Bella

| Código | Descripción |
|--------|---------------------|
| 021204 | Vinagrera Bella 2/p |
| 021205 | Vinagrera Bella 4/p |

Molinillos de pimienta

Paris

| Código | Descripción | Altura (cm) |
|--------------|------------------|-------------|
| PIMIENTA SAL | | |
| 23447 23454 | Molinillo Madera | 12 |
| 23461 23478 | Molinillo Madera | 18 |
| 23485 23492 | Molinillo Madera | 22 |
| 23508 23515 | Molinillo Madera | 27 |
| 23522 23539 | Molinillo Madera | 30 |
| 23546 23553 | Molinillo Madera | 40 |



Zeli

| Código | Descripción | Altura (cm) |
|--------------|----------------|-------------|
| PIMIENTA SAL | | |
| 24079 24086 | Molinillo Inox | 14 |

Daman

| Código | Descripción | Altura (cm) |
|--------------|----------------------|-------------|
| PIMIENTA SAL | | |
| 25427 25434 | Molinillo Inox/acryl | 16 |
| 25441 25458 | Molinillo Inox/acryl | 21 |



Saleros



Basic
Cod. 62866



Hiperlux
Cod. 62461



Cod. 1523



Cod. 1524



Cod. 1525



Cod. 1514

Servilleteros

Mini-servis Acero



Cod. 8058
Todo inox



Cod. 8060
Inox - Base plástico



Cod. 8061
Inox - Base plástico
Palillero Negro



Cod. 8063
Inox - Base plástico
Palillero Cromado



Cod. 8059
Todo inox
Con portacartas

Mini-servis Madera



Cod. 25000



Cod. 25002
Con portacartas



Cod. 25020
Con palillero

Mini-servis Cobre



Cod. 8058C



Cod. 8059C
Con portacartas

Coctel Inox



Cod. 8064

Coctel Madera



Cod. 140302



Cod. 140301
Con palillero

Engarzadas



Cod. 8062

Presentación

Mini caja cuadrada



Código **Dimensiones (cm)**

2005 17x17x7
2004 21x21x7

Mini caja rectangular



Código **Dimensiones (cm)**

2007 24x16x7

Mini caja alta



Código **Dimensiones (cm)**

2007 17x13x9

Mini palet



Código **Dimensiones (cm)**

2000 12x8
2002 20x12



Código **Descripción** **cm**

1993 Cesto Cuadrado 10x9
1994 Cesto Cuadrado 13x11
1991 Cesto Redondo 8 Ø
1992 Cesto Redondo 9 Ø
1996 Cono Chips 11x23
1995 Cesto Rectangular 25x10



Código **Descripción** **cm**

2815 Carrito 9x11x14
2817 Carrito 12x14x16
2818 Mini Cesta 14x10x5
2819 Mini Cesta 18x13x9

Mini olla



Cod. 6304



Cod. 6304/1

| Código | Dimensiones (cm) |
|--------|------------------|
| 6304 | 9x6 |
| 6304/1 | 9x6 |

Mini cazo



Cod. 6302



Cod. 6302/1

| Código | Dimensiones (cm) |
|--------|------------------|
| 6302 | 7x5 |
| 6302/1 | 7x5 |

Mini wok



| Código | Dimensiones (cm) |
|--------|------------------|
| 6305 | 11x5 |

Mini cubo



Cod. 6309-10-12



Cod. 6309-10-1

Mini lechera



| Código | Capacidad (cl) |
|--------|----------------|
| 6306 | 80 |
| 6307 | 150 |
| 6308 | 300 |

| Código | Dimensiones (cm) |
|--------|------------------|
| 6309 | 7x7 |
| 6310 | 9x9 |
| 6312 | 12x12 |
| 6309/1 | 7x7 |
| 6310/1 | 9x9 |

Mini rustidera



Cod. 6301



Cod. 6301/1

| Código | Dimensiones (cm) |
|--------|------------------|
| 6301 | 14 |
| 6301/1 | 14 |

Mini salsaera



| Código | Dimensiones (cm) |
|--------|------------------|
| 6311 | 5x3 |

Mini sartén



| Código | Dimensiones (cm) |
|--------|------------------|
| 6303 | 10x3 |



Botellas



3904



3903



3900



3901



3902



3909



3910



3911



3906



| Código | Dimensiones (cm) |
|--------|------------------|
| 3900 | 7,5x29 |
| 3901 | 7,5x29 |
| 3902 | 7,5x29 |
| 3903 | 12x46 |
| 3904 | 13x45 |
| 3906 | 7x24,5 |
| 3909 | 8x30 |
| 3910 | 8x30 |
| 3911 | 8x30 |

Jamoneras

Huelva



| Código | Descripción |
|--------|-------------|
|--------|-------------|

| | |
|------|-------------|
| 3919 | Color Nogal |
|------|-------------|

Rioja



| Código | Descripción |
|--------|-------------|
|--------|-------------|

| | |
|------|---------------|
| 4091 | Color Natural |
| 8921 | Color Nogal |
| 4237 | Color Tabaco |

Rioja Alto



| Código | Descripción |
|--------|-------------|
|--------|-------------|

| | |
|------|---------------|
| 9249 | Color Natural |
| 6316 | Color Tabaco |

Elite Inoxidable



| Código | Descripción |
|--------|-------------|
|--------|-------------|

| | |
|------|-------------------|
| 4240 | Polietileno Negro |
|------|-------------------|

Pata Negra



| Código | Descripción |
|--------|-------------|
|--------|-------------|

| | |
|------|---------------|
| 9256 | Color Natural |
| 6293 | Color Tabaco |
| 8105 | Color Roble |

Elite Plus Inoxidable



| Código | Descripción |
|--------|-------------|
|--------|-------------|

| | |
|------|-------------------|
| 4299 | Polietileno Negro |
|------|-------------------|

Mesa Jamonera



| Código | Descripción |
|--------|-------------|
|--------|-------------|

| | |
|-------|-----------------|
| 14021 | Mesa 600x600 mm |
| 14045 | Mesa 800x600 mm |



| Código | Descripción |
|--------|-------------|
|--------|-------------|

| | |
|-------|------------------|
| 14069 | Mesa 1200x600 mm |
|-------|------------------|

Panera Mimbre Redonda



| Código | Dimensiones (cm) |
|--------|------------------|
| 1020 | 22 Ø |
| 1021 | 25 Ø |
| 1022 | 29 Ø |
| 1023 | 32 Ø |

Panera Mimbre Oval



| Código | Dimensiones (cm) |
|--------|------------------|
| 1030 | 20,0 |
| 1031 | 22,0 |
| 1032 | 25,0 |
| 1033 | 28,0 |
| 1034 | 31,0 |
| 1035 | 34,0 |

Panera Polyrattan



| Código | Descripción | Dimensiones (cm) |
|--------|----------------------|------------------|
| 30279 | Panera Oval | 18x12 |
| 30280 | Panera Oval | 23x15 |
| 30282 | Panera Oval Baguette | 21x10 |
| 30284 | Panera Oval Baguette | 36x15 |
| 30281 | Panera Redonda | 20 Ø |
| 30285 | Panera Redonda | 25 Ø |
| 30283 | Panera Rectangular | 22x15 |
| 30286 | Panera Rectangular | 30x22 |
| 30288 | Panera Rectangular | 41x29 |
| 30287 | Panera Cuadrada | 24x24 |

Tela Beige



| Código | Dimensiones (cm) |
|--------|------------------|
| 30340 | 17 Ø |
| 30350 | 20 Ø |
| 30360 | 20x15 |
| 30370 | 25x18 |

Tela Beige/Negra



| Código | Dimensiones (cm) |
|--------|------------------|
| 30341 | 17 Ø |
| 30351 | 20 Ø |
| 30361 | 20x15 |
| 3031 | 25x18 |

Polipropileno Colores



| Código | Descripción | Dimensiones (cm) |
|---------|-------------|------------------|
| B919021 | Redonda | 18,5 Ø x 7,5h |
| B919012 | Oval | 24,5x18,5x8 |
| B919032 | Oval | 24x14,5x8,5 |
| B919043 | Rectangular | 23x18x8 |
| B919058 | Baguette | 28x11x,5 |
| B919008 | Cubiertos | 12,5 Ø x 14h |

Colores disponibles



Portamenús

LÍNEAS

FASHION

Piel Regenerada
Espesor 1,2 mm - 14 color

ECO

Fibra Celulosa
Espesor 0,8 mm - 1 color
Espesor 0,6 mm - 3 color
Espesor 1,5 mm - 3 color

VINTAGE

Fibra Celulosa
Espesor 0,5 mm - 1 color
Espesor 1,0 mm - 1 color

SUGUERO

Corcho Natural
Espesor 1,4 mm - 1 color
Espesor 2,5 mm - 3 color

GOLD

Piel Regenerada
Espesor 1,2 mm - 1 color

FORMATOS



Maxi
21x42 cm



A4
21x42 cm



4RE
21x42 cm



Club
21x42 cm



A4 Horizontal
21x42 cm



Quadrato
21x42 cm



Golfo
21x42 cm



Popis
21x42 cm



Club Horizontal
21x42 cm

ETIQUETAS



Metal Satinado
Personalizable láser



Metal Brillante
Personalizable láser



Patch
Personalizable láser



Minimalista
Sin etiqueta

INTERIOR



A4 Horizontal
21x42 cm



A4 Horizontal
21x42 cm



A4 Horizontal
21x42 cm



A4 Horizontal
21x42 cm

Fashion



Naranja
1,2 mm



Violeta
1,2 mm



Verde
1,2 mm



Azul
1,2 mm



Burdeos
1,2 mm



Marrón
1,2 mm



Negro
1,2 mm



Gris
1,2 mm



Avestruz Blanco
1,2 mm



Avestruz Negro
1,2 mm



Cocodrilo Marrón
1,2 mm



Cocodrilo Blanco
1,2 mm



Cocodrilo Negro
1,2 mm



Cocodrilo Violeta
1,2 mm

Eco



Gris
0,6 / 1,5 mm



Negro
0,6 / 0,8 / 1,5 mm



Natural
0,6 / 0,8 mm



Marrón
0,8 / 1,5 mm



Marrón
1,2 mm

Sughero



Natural
1,4 mm



Blanco
2,5 mm



Negro
2,5 mm



Marrón
2,5 mm



Marrón
0,5 / 1,0 mm

Vintage

Fuentes / Bandejas

Fuente oval 18/10

| Código | Dimensiones (cm) |
|--------|------------------|
|--------|------------------|

| | |
|-------|-------|
| 62820 | |
| 62825 | 25x17 |
| 62830 | 30x20 |
| 62835 | 35x23 |
| 62840 | 40x26 |
| 62845 | 40x29 |
| 62850 | 50x31 |
| 62871 | 70x32 |



Fuente pescado 18/10

| Código | Dimensiones (cm) |
|--------|------------------|
|--------|------------------|

| | |
|-------|-------|
| 62860 | 60x26 |
| 62880 | 80x30 |



Fuente oval honda 18% CR

| Código | Dimensiones (cm) |
|--------|------------------|
|--------|------------------|

| | |
|-------|-----------|
| 61828 | 30x20x4,5 |
| 61832 | 35x24x4,5 |
| 61838 | 40x26x4,5 |
| 61843 | 45x29x4,5 |
| 61848 | 50x31x4,7 |



Bandeja camarero

| Código | Dimensiones (cm) |
|--------|------------------|
|--------|------------------|

| | |
|-------|------|
| 62841 | 40 Ø |
|-------|------|



Bandeja octogonal 18/10

| Código | Dimensiones (cm) |
|--------|------------------|
|--------|------------------|

| | |
|-------|-------|
| 65026 | 25x20 |
| 65031 | 31x24 |
| 65037 | 37x27 |
| 65041 | 41x32 |
| 65046 | 46x36 |



Fuente redonda 18/10

| Código | Dimensiones (cm) |
|--------|------------------|
|--------|------------------|

| | |
|-------|------|
| 62831 | 30 Ø |
| 62836 | 35 Ø |



Bandeja camarero antideslizante

| Código | Dimensiones (cm) |
|--------|------------------|
|--------|------------------|

| | |
|---------|-------------|
| P956035 | Negro 35 Ø |
| P956040 | Negro 40 Ø |
| P956135 | Marrón 35 Ø |
| P956140 | Marrón 40 Ø |



Bandeja oval antideslizante



| Código | Descripción | Dimensiones (cm) |
|--------|-------------|------------------|
|--------|-------------|------------------|

| | | |
|---------|------------------|----------|
| P862100 | Bandeja Oval | 68x56 |
| P863000 | Soporte Bandejas | 47x47x82 |



Pizarras Sandwich

| Código | Descripción | Dimensiones (cm) |
|--------|--------------------------|------------------|
| P21000 | Pizarra Caballete Duo | 75x135 |
| P21001 | Pizarra Caballete Duo | 55x85 |
| P21003 | Pizarra Caballete Simple | 55x85 |



Pizarras

Pizarras Pared

| Código | Descripción | Dimensiones (cm) |
|--------|-------------------|------------------|
| P21004 | Pizarra Universal | 40x50 |
| P21005 | Pizarra Universal | 50x60 |
| P21006 | Pizarra Universal | 60x80 |
| P21007 | Pizarra Universal | 70x90 |
| P21008 | Pizarra Universal | 80x100 |
| P21013 | Pizarra Curva | 50x80 |



Pizarras



| Código | cm |
|--------|--------|
| 000020 | 40x150 |
| 000021 | 55x100 |
| 000022 | 40x100 |
| 000023 | 45x70 |
| 000024 | 40x50 |
| 000025 | 20x100 |
| 000026 | 20x50 |
| 000027 | 21x30 |
| 000028 | 15x21 |

Pizarras de PVC para pared o caballete

Pizarras Sobremesa

| Código | Descripción | Dimensiones (cm) |
|--------|-------------------|------------------|
| 000001 | Pizarra Sobremesa | 30x40 |
| 000002 | Pizarra Sobremesa | 21x30 |
| 000003 | Pizarra Sobremesa | 15x21 |
| 000004 | Pizarra Sobremesa | 8x15 |
| 000005 | Portamenú | 15x21 |



Caballetes



Pizarras Sobremesa

| Código | Descripción | Dimensiones (cm) |
|--------|-------------|------------------|
| 000010 | Una cara | 30x165 |
| 000011 | Dos caras | 30x115 |
| 000012 | Dos caras | 43x165 |



Pizarras Sobremesa

| Código | Descripción | Dimensiones (cm) |
|--------|-------------------|------------------|
| P21015 | Pizarra Sobremesa | 10x15 |
| P21016 | Pizarra Sobremesa | 15x21 |
| P21017 | Pizarra Sobremesa | 21x30 |

Rotuladores



| Código | Descripción |
|--------|------------------------------|
| SMA510 | Rotulador Fino 2-6 mm trazo |
| SMA720 | Rotulador Fino 7-15 mm trazo |

Coctelería



| Código | Descripción | Características |
|--------|------------------------|----------------------------|
| 93201 | Coctelera Boston Inox | 30 cm x 9 Ø - 0,70/0,40 lt |
| 93140 | Coctelera Boston Cobre | 30 cm x 9 Ø - 0,70/0,40 lt |
| 93179 | Coctelera Parisien | 24 cm x 9,5 Ø - 0,70 lt |
| 62304 | Coctelera Tapón Inox | 0,75 lt |



| Código | Descripción | Características |
|--------|----------------------|--------------------------|
| 93134 | Cuchara Cóctel Inox | 27 cm |
| 93034 | Cuchara Cóctel Cobre | 27 cm |
| 93101 | Vaso mezclador | 19 cm x 11,5 Ø - 0,95 lt |
| B001 | Botella Bitter | |
| 62326 | Colador Gusanillo | 15 cm x 10 Ø |



| Código | Descripción | Características |
|--------|--------------|------------------------|
| 93164 | Jigger Inox | 11 cm x 4 Ø - 2,5/5 cl |
| 93165 | Jigger Cobre | 11 cm x 4 Ø - 2,5/5 cl |



| Código | Descripción |
|--------|------------------|
| DP212 | Dosificador 2 cl |
| DP213 | Dosificador 3 cl |
| DP214 | Dosificador 4 cl |
| DP215 | Dosificador 5 cl |
| 93319 | Tapón Vertedor |



| Código | Descripción | Características |
|--------|---------------------|-----------------|
| 93180 | Machacador Madera | 21 cm |
| 93181 | Machacador Plástico | 21 cm |



| Código | Descripción | Características |
|--------|-----------------------|-------------------|
| N4107 | Exprimidor Manual | 15,5 cm |
| 62912 | Exprimidor Manual | 12 cm Ø - 0,20 lt |
| N4179 | Pinza Exprimidora | 8 cm |
| N4190 | Rallador Nuez Tostada | 13,6 cm |
| 93189 | Prensador Lima | 21,7 cm |



| Código | Descripción |
|--------|-----------------|
| 36009 | Picadora Manual |
| 93192 | Pala hielo |



| Código | Descripción | Características |
|--------|-------------------------|------------------------|
| 93310 | Moscow Mule | 9 cm x 9 Ø - 0,50 lt |
| 93311 | Moscow Mule Martilleada | 9,5 cm x 9 Ø - 0,55 lt |



| Código | Descripción |
|--------|------------------|
| 93175 | Ribeteador Copas |



| Código | Descripción | Dimensiones (mm) |
|--------|-------------|------------------|
| N4401 | Caja 4 Dept | 305x147x93 |
| N4402 | Caja 5 Dept | 380x147x93 |
| N4403 | Caja 6 Dept | 458x147x93 |

| Código | Descripción |
|--------|-----------------|
| 93174 | Organizador Bar |



| Código | Descripción | Dimensiones (mm) |
|--------|---------------|------------------|
| 93166 | Tapete Cóctel | 30x15 |
| 93167 | Tapete Cóctel | 45x31 |
| 93173 | Tapete Cóctel | 57x8 |
| 93168 | Tapete Cóctel | 60x8 |

| Código | Descripción | Características |
|--------|----------------------|-----------------------|
| 93144 | Botella Store & Pour | 33 cm x 9 Ø - 1 lt |
| 94144 | Botella Store & Pour | 35 cm x 12,5 Ø - 2 lt |

Colores:



| Código | Descripción | Características |
|--------|-------------|---------------------|
| 68601 | Sifón Soda | 39 cm x 10 Ø - 1 lt |
| 68603 | Cargas CO2 | Caja 24 ud |

Servicio vino



| Código | Descripción |
|--------|---------------------------|
| 63012 | Sacacorchos Pared Cromado |
| 63010 | Sacacorchos Pared Negro |



| Código | Descripción |
|--------|-------------------|
| 63019 | Anillo antigoteo |
| 63037 | Descapsulador |
| 63022 | Boquilla Servidor |
| 93135 | Tapón Champán |



Sacacorchos
Dos Tiempos
Cod. 107



| Código | Descripción |
|--------|-------------------------------|
| 63033 | Bomba vacío (set + 2 tapones) |
| 63035 | Tapón bomba vacío |
| 63019 | Anilla Anti-Goteo |
| 63022 | Vertedor - Boquilla |

Sacacorchos Doble Palanca
Cod. 63013



| Código | Descripción |
|--------|--------------------|
| 63033 | Bomba vacío manual |
| R63033 | Tapón Bomba (2 ud) |



| Código | Descripción |
|--------|-------------|
|--------|-------------|

- | | |
|--------|------------------------|
| 107725 | Limpiador copas |
| 107724 | Limpiador decantadores |
| 107715 | Catavinos Sommelier |
| 107721 | Aireador vino |



| Código | Descripción | Capacidad | Dimensiones |
|--------|-------------|-----------|-------------|
|--------|-------------|-----------|-------------|

- | | | | |
|-------|---------------|-------------|-------------|
| 69178 | Armario Vinos | 8 botellas | 28x51x45 cm |
| 69187 | Armario Vinos | 8 botellas | 46x51x28 cm |
| 69171 | Armario Vinos | 18 botellas | 38x50x65 cm |
| 69175 | Armario Vinos | 28 botellas | 48x54x74 cm |

Cambio - Palilleros - Pinzas

Bandejas cambio

| Código | Descripción | Dimensiones (cm) |
|--------|----------------------|------------------|
| 68007 | Bandeja inox c/pinza | 15x11 |
| 68017 | Bandeja inox c/pinza | 21x12 |
| 68020 | Bandeja inox Luxe | 21x12 |
| 120601 | Bandeja madera | 15x11 |
| 120602 | Caja madera | 15x11 |
| BAR12 | Plato cambio madera | 12,5 Ø |
| 61110 | Plato cambio inox | 10,5 Ø |



Palilleros

| Código | Descripción |
|--------|-------------------------|
| 983 | Palillero cuadrado |
| 1155 | Palillero redondo |
| 120203 | Palillero madera |
| 120201 | Palillero madera c/base |
| 62469 | Palillero hiperlux |
| 62470 | Palillero luxe |



| Código | Descripción |
|--------|------------------|
| 3025 | Azucarero Lys |
| 3022 | Salero Lys |
| 3006 | Dosificador miel |



Pinzas

| Código | Descripción | Dimensiones (cm) |
|--------|----------------------------|------------------|
| 62306 | Pinza hielo | 18,5 |
| 68008 | Pinza repostería c/anillos | 16,0 |
| 62982 | Pinza pan | 23,0 |
| 62317 | Pinza repostería | 20,0 |
| 62307 | Pinza servicio mesa | 21,0 |
| 62989 | Pinza cazuelas | 20,0 |



ALMACENAJE

Storage • Stockage • Stoccaggio • Storage



Cesta Cristalería

FLAP-RACK®

PATENTED EXCLUSIVE

SISTEMA DE MONTAJE Y DESMONTAJE FÁCIL, SEGURO Y SENCILLA PERSONALIZACIÓN /

ABIERTA

APERTURAS PARA MÁXIMA LIMPIEZA



CERRADA

IDEALES PARA EL TRANSPORTE Y EL ALMACENAMIENTO



FLAP-RACK®: fácil montaje / desmontaje

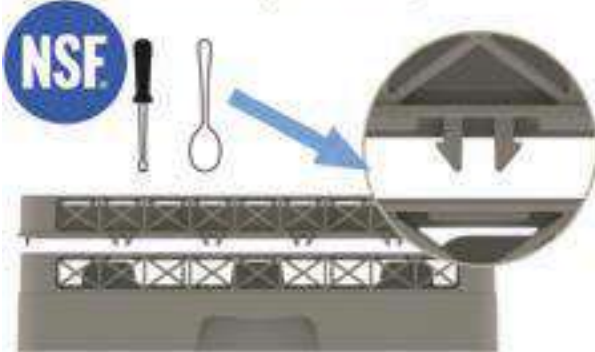

* Copolímeros altamente resistentes a sustancias químicas y temperaturas de hasta 95 °C



Sistema patentado que permite cerrar y abrir las paredes de las cestas y extensiones fácilmente.



LAVADO: Mayor limpieza



TRANSPORTE: Mayor seguridad



Almacenamiento: Mayor higiene



Ø max 151 mm



| Código | Modelo |
|--------|--------------------|
| 5090 | Cesta Base 9 Dptos |
| 5091 | Altura 9 Dptos |

Ø max 113 mm



| Código | Modelo |
|--------|---------------------|
| 5160 | Cesta Base 16 Dptos |
| 5161 | Altura 16 Dptos |

Ø max 89 mm



| Código | Modelo |
|--------|---------------------|
| 5250 | Cesta Base 25 Dptos |
| 5251 | Altura 25 Dptos |

Ø max 73 mm



| Código | Modelo |
|--------|---------------------|
| 5360 | Cesta Base 36 Dptos |
| 5361 | Altura 36 Dptos |

Ø max 63 mm



| Código | Modelo |
|--------|---------------------|
| 5490 | Cesta Base 49 Dptos |
| 5491 | Altura 49 Dptos |



| Código | Modelo |
|--------|-----------------|
| 5002 | Cesta Universal |
| 5003 | Cesta Platos |
| 5000 | Cesta Cubiertas |

Cestas Vajilla



Limpieza y secado rápido.



Almacenamiento y transporte más seguro e higiénico.

Cestas especiales para platos: ideales para el lavado, almacenamiento y transporte de platos. Perfectas para banquetes, hoteles, colectividades y empresas de alquiler de material para la hostelería. Reducen las roturas de platos, minimizan el coste del transporte y manipulación.

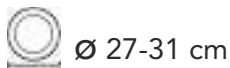

| Código | Altura Máx cm | Capacidad Platos |
|-----------|---------------|------------------|
| 1412-6 | 3,5 | 14 |
| 1412-6F1* | 3,5 | 14 |

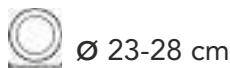

| Código | Altura Máx cm | Capacidad Platos |
|-----------|---------------|------------------|
| 1510-5 | 3,5 | 15 |
| 1510-5F1* | 3,5 | 15 |

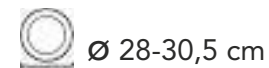

| Código | Altura Máx cm | Capacidad Platos |
|-----------|---------------|------------------|
| 1912-6 | 2,5 | 19 |
| 1912-6F1* | 2,5 | 19 |

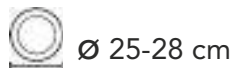

| Código | Altura Máx cm | Capacidad Platos |
|-----------|---------------|------------------|
| 2011-5 | 2,5 | 20 |
| 2011-5F1* | 2,5 | 20 |

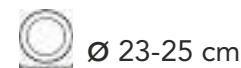

| Código | Altura Máx cm | Capacidad Platos |
|-----------|---------------|------------------|
| 2110-5 | 2,5 | 21 |
| 2110-5F1* | 2,5 | 21 |



| Código | Altura Máx cm | Capacidad Platos |
|-----------|---------------|------------------|
| 3008-4 | 2,5 | 30 |
| 3008-4F1* | 2,5 | 30 |

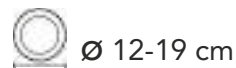

| Código | Altura Máx cm | Capacidad Platos |
|-----------|---------------|------------------|
| 3208-3 | 2,5 | 32 |
| 3208-3F1* | 2,5 | 32 |

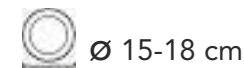

| Código | Altura Máx cm | Capacidad Platos |
|-----------|---------------|------------------|
| 4407-3 | 2 | 44 |
| 4407-3F1* | 2 | 44 |



| Código | Altura Máx cm | Capacidad Platos |
|-----------|---------------|------------------|
| 6305-2 | 2,5 | 63 |
| 6305-2F1* | 2,5 | 63 |

Cestas Bandejas



Cesta Bandejas isotérmicas Ref. 5050



Cesta Grandes Bandejas Ref. 5030



Carros Cestas

Carro Plástico



| Código | Dimensiones (mm) |
|--------|------------------|
|--------|------------------|

| | |
|------|-------------|
| 5015 | 540x540x230 |
| 5017 | 540x540x980 |

Carro Inox



| Código | Dimensiones (mm) |
|--------|------------------|
|--------|------------------|

| | |
|------|--------------|
| 8058 | 640x640x165 |
| 8059 | 640x640x1065 |



| Código | Dimensiones (mm) |
|--------|------------------|
|--------|------------------|

| | |
|------|---------------|
| 8075 | 640x633x1160 |
| 8076 | 640x633x1710 |
| 8077 | 1185x633x1710 |

Cubetas herméticas



Hermético
Hermético

GASTRONORM

Etiqueta Permanente
Etiqueta Permanente

ColorClip

Fácil limpieza
Fácil limpieza

Regleta de medición
Regla de medición

Translúcido
Translúcido

Cubetas herméticas de Polipropileno

GN-1/9



| Código | Dimensiones (mm) | Capacidad (lt) |
|--------|------------------|----------------|
| 3020 | 176x108x65 | 0,6 |
| 3021 | 176x108x100 | 1,0 |
| 3022 | 176x108x150 | 1,5 |

GN-1/6



| Código | Dimensiones (mm) | Capacidad (lt) |
|--------|------------------|----------------|
| 3023 | 176x162x65 | 1,1 |
| 3024 | 176x162x100 | 1,8 |
| 3025 | 176x162x150 | 2,6 |

GN-1/4



| Código | Dimensiones (mm) | Capacidad (lt) |
|--------|------------------|----------------|
| 3026 | 265x162x65 | 1,8 |
| 3027 | 265x162x100 | 2,8 |
| 3028 | 265x162x150 | 4,3 |

GN-1/3



| Código | Dimensiones (mm) | Capacidad (lt) |
|--------|------------------|----------------|
| 3029 | 325x176x65 | 2,5 |
| 3030 | 325x176x100 | 4,0 |
| 3031 | 325x176x150 | 6,0 |

GN-1/2



| Código | Dimensiones (mm) | Capacidad (lt) |
|--------|------------------|----------------|
| 3032 | 325x265x65 | 4,0 |
| 3033 | 325x265x100 | 6,5 |
| 3034 | 325x265x150 | 10,0 |
| 3035 | 325x265x200 | 12,5 |

GN-2/3



| Código | Dimensiones (mm) | Capacidad (lt) |
|--------|------------------|----------------|
| 470 | 354x325x150 | 13,5 |
| 471 | 354x325x200 | 19,0 |

GN-1/1



| Código | Dimensiones (mm) | Capacidad (lt) |
|--------|------------------|----------------|
| 3044 | 530x325x65 | 8,3 |
| 3036 | 530x325x100 | 13,7 |
| 3037 | 530x325x150 | 21,0 |
| 3038 | 530x325x200 | 28,0 |

Herméticos alérgenos

GN-1/6



GN-1/4



| Código | Dimensiones (mm) | Capacidad (lt) |
|--------|------------------|----------------|
| 61390 | 176x162x150 | 2,6 |
| 61392 | 265x162x150 | 4,3 |
| 61393 | 325x175x150 | 6,0 |
| 61391 | 325x265x150 | 10,0 |

GN-1/3



GN-1/2



El color morado del hermético Araven identifica y diferencia el alimento de un cliente que padece alergia o intolerancias alimentarias para independizarlo del resto de contenedores y protegerlo de posibles contaminaciones de sustancias potencialmente alérgicas para él.

Cubetas policarbonato gn



Cubetas de policarbonato herméticas, con alta resistencia al impacto y medidas gastronorm para una perfecta modularidad.

| | | | |
|---------------------------------|--|------------------------------------|--|
| Hermético | | Alta resistencia al impacto | |
| GASTRONORM | | Transparencia | |
| Etiqueta Permanente | | | |
| Cierre cubeta con cubeta | | | |
| Fácil limpieza | | | |
| Regleta de medición | | | |
| Ergonomía | | | |
| | | | |



GN-1/6

| Código | Dimensiones (mm) | Capacidad (lt) |
|--------|------------------|----------------|
|--------|------------------|----------------|

| | | |
|-------|-------------|-----|
| 09796 | 176x162x65 | 1,0 |
| 09797 | 176x162x100 | 1,5 |
| 09798 | 176x162x150 | 2,1 |



GN-1/4

| Código | Dimensiones (mm) | Capacidad (lt) |
|--------|------------------|----------------|
|--------|------------------|----------------|

| | | |
|-------|-------------|-----|
| 09816 | 265x162x65 | 1,2 |
| 09817 | 265x162x100 | 2,2 |
| 09818 | 265x162x150 | 3,3 |



GN-1/3

| Código | Dimensiones (mm) | Capacidad (lt) |
|--------|------------------|----------------|
|--------|------------------|----------------|

| | | |
|-------|-------------|-----|
| 09808 | 325x176x65 | 1,6 |
| 09819 | 325x176x100 | 3,0 |
| 09820 | 325x176x150 | 4,7 |
| 09831 | 325x176x200 | 6,0 |



GN-1/2

| Código | Dimensiones (mm) | Capacidad (lt) |
|--------|------------------|----------------|
|--------|------------------|----------------|

| | | |
|-------|-------------|------|
| 09821 | 325x265x65 | 3,9 |
| 09822 | 325x265x100 | 6,0 |
| 09823 | 325x265x150 | 9,5 |
| 09834 | 325x265x200 | 11,3 |



GN-1/1

| Código | Dimensiones (mm) | Capacidad (lt) |
|--------|------------------|----------------|
|--------|------------------|----------------|

| | | |
|-------|-------------|------|
| 09826 | 530x325x65 | 8,3 |
| 09827 | 530x325x100 | 13,0 |
| 09828 | 530x325x150 | 19,6 |
| 09835 | 530x325x200 | 24,0 |



Tapas

| Código | Modelo |
|--------|--------|
|--------|--------|

| | |
|-------|--------|
| 09852 | GN-1/6 |
| 09853 | GN-1/4 |
| 09854 | GN-1/3 |
| 09855 | GN-1/2 |
| 09856 | GN-1/1 |



Cubetas sin BPA



Cubetas de ABS libres de BPA para cumplir la normativa europea respecto al uso de Bisfenoles.

GN-1/6

| Código | Dimensiones (mm) | Capacidad (lt) |
|--------|------------------|----------------|
|--------|------------------|----------------|

| | | |
|-------|-------------|------|
| 07796 | 176x162x65 | 0,75 |
| 07797 | 176x162x100 | 1,25 |
| 07798 | 176x162x150 | 1,90 |



GN-1/4

| Código | Dimensiones (mm) | Capacidad (lt) |
|--------|------------------|----------------|
|--------|------------------|----------------|

| | | |
|-------|-------------|------|
| 07816 | 265x162x65 | 1,20 |
| 07817 | 265x162x100 | 2,20 |
| 07818 | 265x162x150 | 3,30 |



GN-1/3

| Código | Dimensiones (mm) | Capacidad (lt) |
|--------|------------------|----------------|
|--------|------------------|----------------|

| | | |
|-------|-------------|------|
| 07808 | 325x176x65 | 1,65 |
| 07819 | 325x176x100 | 3,70 |
| 07820 | 325x176x150 | 4,70 |
| 07831 | 325x176x200 | 6,00 |



GN-1/2

| Código | Dimensiones (mm) | Capacidad (lt) |
|--------|------------------|----------------|
|--------|------------------|----------------|

| | | |
|-------|-------------|-------|
| 07821 | 325x265x65 | 3,90 |
| 07822 | 325x265x100 | 4,85 |
| 07823 | 325x265x150 | 7,90 |
| 07834 | 325x265x200 | 10,25 |



GN-1/1

| Código | Dimensiones (mm) | Capacidad (lt) |
|--------|------------------|----------------|
|--------|------------------|----------------|

| | | |
|-------|-------------|-------|
| 07826 | 530x325x65 | 6,25 |
| 07827 | 530x325x100 | 13,00 |
| 07828 | 530x325x150 | 19,60 |
| 07835 | 530x325x200 | 24,00 |

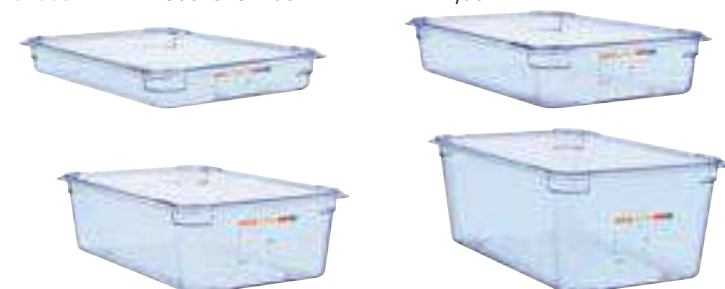

Tapas

| Código | Modelo |
|--------|--------|
|--------|--------|

| | |
|-------|--------|
| 09852 | GN-1/6 |
| 09853 | GN-1/4 |
| 09854 | GN-1/3 |
| 09855 | GN-1/2 |
| 09856 | GN-1/1 |



Hermético de silicona

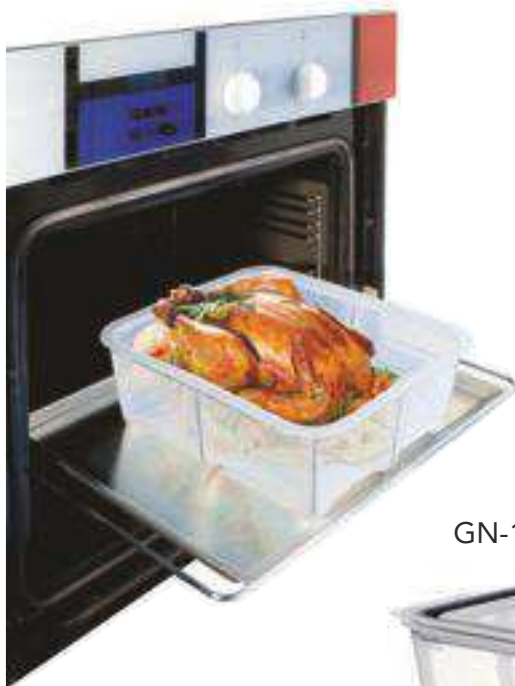

Directo al horno desde el congelador.

| Código | Dimensiones (mm) | Capacidad (lt) |
|--------|----------------------|----------------|
| 01802 | GN-1/3 (325x175x100) | 3,6 |
| 01803 | GN-1/3 (325x175x150) | 5,2 |
| 01804 | GN-1/2 (325x265x100) | 6,0 |
| 01805 | GN-1/2 (325x265x150) | 8,7 |
| 01806 | GN-1/1 (530x325x100) | 13,00 |
| 01807 | GN-1/1 (530x325x150) | 19,3 |

GN-1/2 (325x265x100)



GN-1/3 (325x175x150)



No usar la tapa en el horno

GN-1/1 (530x325x150)



Antiadherente

Conservación



ALMACENAJE

Tapas de silicona

Adaptables a herméticos de polipropileno, cubetas policarbonato y cubetas libres de BPA.



| Código | Tipo | (mm) |
|--------|------|---------|
| 91811 | 1/9 | 167x103 |
| 91812 | 1/6 | 167x154 |
| 91813 | 1/4 | 252x154 |
| 91814 | 1/3 | 109x167 |
| 91815 | 1/2 | 109x252 |
| 91816 | 2/3 | 336x309 |
| 91817 | 1/1 | 503x309 |

Cubetas gn - Inoxidables



PROFESSIONAL COOKWARE

- Ángulos y bordes reforzados.
- Apilables.
- Higiene y facilidad de almacenamiento.
- Totalmente modulares.

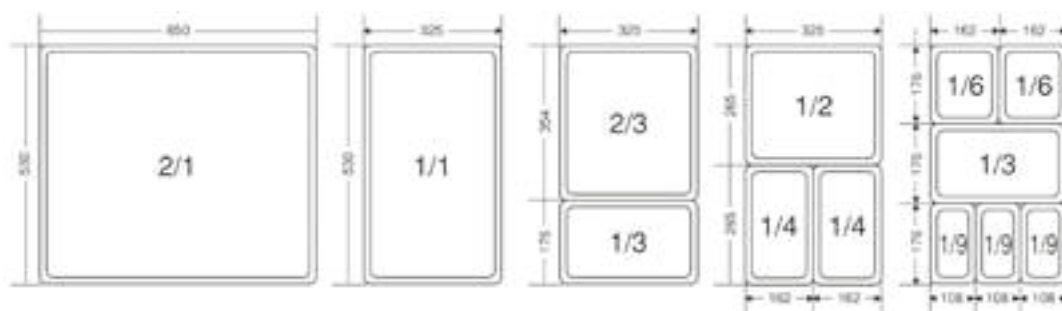

GN 2/1 - 650x530 mm



| Código | h (mm) | (lt) |
|--------|--------|-------|
| 210201 | 65 | 6,25 |
| 210401 | 40 | 13,00 |
| 210651 | 62 | 19,60 |
| 211001 | 100 | 24,00 |
| 211501 | 150 | 43,10 |
| 212001 | 200 | 52,00 |

GN 1/1 - 530x325 mm



| Código | h (mm) | (lt) |
|--------|--------|-------|
| 110201 | 20 | 2,80 |
| 110401 | 40 | 5,10 |
| 110551 | 55 | 7,00 |
| 110651 | 65 | 8,30 |
| 111001 | 100 | 14,20 |
| 111501 | 150 | 20,20 |
| 112001 | 200 | 26,00 |

GN 2/3 - 353x325 mm



| Código | h (mm) | (lt) |
|--------|--------|-------|
| 230201 | 20 | 1,70 |
| 230401 | 40 | 3,10 |
| 230651 | 65 | 5,60 |
| 231001 | 100 | 8,80 |
| 231501 | 150 | 13,20 |
| 232001 | 200 | 18,30 |

GN 1/2 - 325x265 mm



| Código | h (mm) | (lt) |
|--------|--------|-------|
| 120201 | 20 | 1,20 |
| 120401 | 40 | 2,20 |
| 120651 | 65 | 4,10 |
| 121001 | 100 | 6,10 |
| 121501 | 150 | 9,10 |
| 122001 | 200 | 12,00 |

GN 2/4 - 530x165 mm



| Código | h (mm) | (lt) |
|--------|--------|-------|
| 240401 | 40 | 1,80 |
| 240651 | 65 | 4,00 |
| 241001 | 100 | 6,00 |
| 241501 | 150 | 10,00 |

GN 1/3 - 325x176 mm



| Código | h (mm) | (lt) |
|--------|--------|------|
| 130201 | 20 | 0,80 |
| 130401 | 40 | 1,50 |
| 130651 | 65 | 2,50 |
| 131001 | 100 | 3,80 |
| 131501 | 150 | 5,60 |
| 132001 | 200 | 7,30 |

GN 1/4 - 265x162 mm



| Código | h (mm) | (lt) |
|--------|--------|------|
| 140201 | 20 | 0,50 |
| 140651 | 65 | 1,80 |
| 141001 | 100 | 2,80 |
| 141501 | 150 | 4,10 |
| 142001 | 200 | 5,00 |

GN 1/6 - 176x162 mm



| Código | h (mm) | (lt) |
|--------|--------|------|
| 160651 | 65 | 1,00 |
| 161001 | 100 | 1,60 |
| 161501 | 150 | 2,20 |
| 162001 | 200 | 2,90 |

GN 1/9 - 176x108 mm



| Código | h (mm) | (lt) |
|--------|--------|------|
| 190651 | 65 | 0,60 |
| 191001 | 100 | 0,80 |

Cubetas gn perforadas

GN 2/1 - 650x530 mm



| Código | h (mm) |
|--------|--------|
|--------|--------|

| | |
|--------|-------|
| 210202 | 65* |
| 210402 | 40* |
| 210652 | 65* |
| 211002 | 100** |
| 211502 | 150** |
| 212002 | 200** |

GN 1/1 - 530x325 mm



| Código | h (mm) |
|--------|--------|
|--------|--------|

| | |
|--------|-------|
| 110202 | 20* |
| 110402 | 40* |
| 110552 | 55* |
| 110652 | 65** |
| 111002 | 100** |
| 111502 | 150** |
| 112002 | 200** |

GN 2/3 - 353x325 mm



| Código | h (mm) |
|--------|--------|
|--------|--------|

| | |
|--------|-------|
| 230202 | 20* |
| 230402 | 40* |
| 230652 | 65* |
| 231002 | 100** |
| 231502 | 150** |
| 232002 | 200** |

GN 1/2 - 325x265 mm



| Código | h (mm) |
|--------|--------|
|--------|--------|

| | |
|--------|-------|
| 120652 | 65* |
| 121002 | 100* |
| 121502 | 150* |
| 122002 | 200** |

GN 1/3 - 325x176 mm



| Código | h (mm) |
|--------|--------|
|--------|--------|

| | |
|--------|-------|
| 130202 | 20* |
| 130402 | 40* |
| 130652 | 65* |
| 131002 | 100** |
| 131502 | 150** |
| 132002 | 200** |

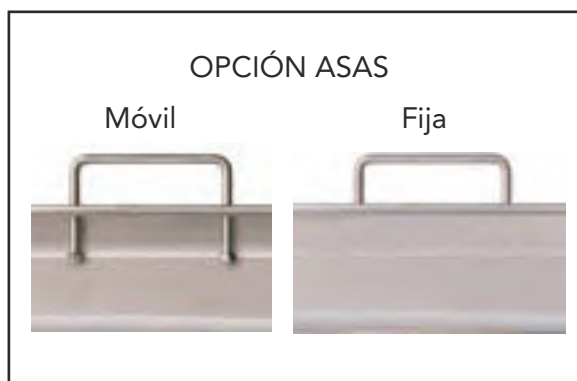

* Fondo perforado

** Fondo y laterales perforados

Cubetas gn fondo difusor

Sin asas



Con asas



| Código | Tipo | h (mm) | (lt) |
|--------|------|--------|------|
|--------|------|--------|------|

| | | | |
|--------|-----|-----|-------|
| 1104F1 | 1/1 | 40 | 5,10 |
| 1106F1 | 1/1 | 65 | 8,30 |
| 1110F1 | 1/1 | 100 | 14,20 |
| 1115F1 | 1/1 | 150 | 20,20 |
| 1204F1 | 1/2 | 40 | 2,20 |
| 1206F1 | 1/2 | 65 | 4,10 |
| 1210F1 | 1/2 | 100 | 6,10 |
| 1215F1 | 1/2 | 150 | 9,10 |

| Código | Tipo | h (mm) | (lt) |
|--------|------|--------|------|
|--------|------|--------|------|

| | | | |
|--------|-----|-----|-------|
| 1110F2 | 1/1 | 100 | 14,20 |
| 1115F2 | 1/1 | 150 | 20,20 |
| 1210F2 | 1/2 | 100 | 6,10 |
| 1215F2 | 1/2 | 150 | 9,10 |

Cubetas con fondo difusor adaptadas para la cocción en placa de inducción mediante fondo sandwich.



Tapas gn

| Tamaño - Modelo | A | B | C | D | E |
|-----------------|--------|--------|--------|--------|-------|
| GN-1/1 | 110000 | 110004 | 110001 | 110002 | 1100P |
| GN-2/3 | 230000 | - | 230001 | - | - |
| GN-1/2 | 120000 | 120004 | 120001 | 120002 | 1200P |
| GN-1/3 | 130000 | 130004 | 130001 | 130002 | 1300P |
| GN-1/4 | 140000 | 140004 | 140001 | 140002 | 1400P |
| GN-1/6 | 160000 | 160004 | 160001 | 160002 | 1600P |
| GN-1/9 | 190000 | - | - | - | 1900P |



E - Tapa policarbonato Adaptable



A - Tapa normal



B - Tapa hermética



C - Tapa c/orificio asas



D - Tapa c/orificio asas y cucharón



Fondos perforados

| Código | Tamaño |
|--------|--------|
| 215000 | GN-2/1 |
| 115000 | GN-1/1 |
| 235000 | GN-2/3 |
| 125000 | GN-1/2 |
| 135000 | GN-1/3 |
| 145000 | GN-1/4 |



Perfiles divisorios

| Código | Modelo | Tamaño | Longitud |
|--------|------------------|--------|----------|
| 111111 | Perfil divisorio | GN-1/1 | 53,0 cm |
| 122222 | Perfil divisorio | GN-1/2 | 32,5 cm |



Presentador cubetas

| Código | Modelo | Tamaño |
|--------|------------------|-------------------|
| 100004 | Soporte sólo | 680x150x115 mm |
| 100005 | Conjunto cubetas | 6 GN-1/9 - 65 mm |
| 100006 | Conjunto cubetas | 6 GN-1/9 - 100 mm |
| 100007 | Conjunto cubetas | 4 GN-1/6 - 65 mm |
| 100008 | Conjunto cubetas | 4 GN-1/6 - 100 mm |



Contenedores cuadrados



Policarbonato

| Código | Dimensiones (mm) | (lt) |
|--------|------------------|------|
| 91851 | 180x180x100h | 2,0 |
| 91852 | 180x180x190h | 4,0 |
| 91853 | 225x225x190 | 6,0 |
| 91854 | 225x225x230 | 8,0 |
| 91855 | 285x285x210 | 12,0 |
| 91856 | 285x285x320 | 18,0 |
| 91857 | 285x285x400 | 22,0 |



Polipropileno

| Código | Dimensiones (mm) | (lt) |
|--------|------------------|------|
| 91860 | 180x180x100h | 2,0 |
| 91861 | 180x180x190h | 4,0 |
| 91862 | 225x225x190 | 6,0 |
| 91863 | 225x225x230 | 8,0 |
| 91864 | 285x285x210 | 12,0 |
| 91865 | 285x285x320 | 18,0 |
| 91866 | 285x285x400 | 22,0 |

ColorClip



Ergonomía



Fácil limpieza



Regleta de medición



Zona de protección



PC-Transparencia
PP-Translúcido



Permite el apilamiento



Cubetas sin tapa



1171 - 530x396x205 mm - 35 lts



1134 - 440x350x160 mm - 20 lts



1170 - 530x396x139 mm - 25 lts

| Código | Dimensiones (mm) | (lt) |
|--------|------------------|------|
| 1134 | 440x350x160 | 20,0 |
| 1170 | 530x396x139 | 25,0 |
| 1171 | 530x396x205 | 35,0 |

| Código | Dimensiones (mm) | (lt) |
|--------|------------------|------|
| 01133 | 540x365x80 | 10 |
| 01132 | 485x335x80 | 8 |
| 01131 | 435x285x80 | 5 |
| 01130 | 345x235x75 | 3 |
| 01129 | 300x205x60 | 2 |

Fondos perforados

| Código | Dimensiones (mm) | Cubeta |
|--------|------------------|-----------|
| 01178 | 432x332x12 | 1170-1171 |
| 01182 | 375x300x12 | 1134-1133 |
| 01180 | 416x262x10 | 1132 |
| 01179 | 370x215x10 | 1131 |



Cubetas con tapa



01172 - 530x396x159 mm - 30 lt
Rejilla adaptable 01178



01173 - 530x396x225 mm - 40 lt
Rejilla adaptable 01178



01183 - 530x396x378 mm - 60 lt
Rejilla adaptable 01180
Con ruedas

Food Bacs



01850 - 600x395x410 mm - 50 lt



01870 - 655x435x455 mm - 70 lt
Con ruedas



01890 - 705x465x480 mm - 90 lt
Con ruedas

Contenedores accesibles



GN 1/3
09146
395x200x200 mm
7 lt



GN 2/3
09145
415x340x200 mm
16 lt

Contenedores accesibles FIFO

Sistema FIFO

First In ...

El primer alimento en almacenarse

GN 1/1



First Out ...

El primer alimento en consumirse



| Código | Dimensiones (mm) | (lt) |
|--------|------------------|-------|
| 00918 | 565x340x400 | 50,00 |
| 09144 | 565x340x200 | 22,65 |



Contenedores accesibles con ruedas

Etiqueta Permanente



ColorClip



Ergonomía



GASTRONORM



Fácil limpieza



Translúcido



| Código | Dimensiones (mm) | (lt) |
|--------|------------------|------|
| 00919 | 655x435x560 | 80 |
| 00920 | 705x465x580 | 100 |



09469 - 140x100x250 mm - 190 cl



09459 - 330x160x140 mm - 95 cl



09455 - 250x80x70 mm - 18 cl



09265 - 280x120x116 mm - 60 cl

Carros

Carro servicio

| Código | Medidas (mm) | Medidas estante (mm) | Nº estantes |
|----------|--------------|----------------------|-------------|
| F0260401 | 895x595x950 | 800x500 | 2 |
| F0260402 | 995x595x950 | 900x500 | 2 |
| F0260403 | 1095x595x950 | 1000x600 | 2 |
| F0260404 | 895x595x950 | 800x500 | 3 |
| F0260405 | 995x595x950 | 900x500 | 3 |
| F0260406 | 1095x595x950 | 1000x600 | 3 |
| F0260407 | 995x595x950 | 900x500 | 4 |
| F0260408 | 1095x595x950 | 1000x600 | 4 |



Carro cestas

| Código | Modelo | Tamaño (mm) |
|----------|--------------------|--------------|
| F0260001 | Carro Cestas | 520x520x250 |
| F0260101 | Carro Cestas C/Asa | 731x634x1050 |
| F0261701 | Carro Cestas Guías | 700x630x1700 |



- Construidos en acero inox AISI 304 18/10.
- 4 ruedas 125 mm ø.
- 7 niveles.
- Espacio entre nivele: 201 mm.

ALMACENAJE

Carro emplatar



Sobremesa

- Capacidad:
 - 80 platos ø 200-320 mm.
 - 120 platos ø inferior 200 mm.
- Construido en acero inox ANSI 304 18/10.
- 4 ruedas giratorias 125 mm ø (2 con freno).
- 20x2 niveles.
- Espacio entre niveles: 70 mm.
- Dimensiones: 630x665x1750 mm.
- Rejillas de medidas 540x273 mm en acero inox.



funda carro

Carro bandeja

| Código | Modelo | Medidas estante | Medidas bandeja |
|----------|-----------|-----------------|---------------------|
| F0260601 | GN-1/1 | 460x630x1700 | 530x325 (GN-1/1) |
| F0260901 | GN-2/1 | 660x750x1700 | 650x530 (GN-2/1) |
| F0261001 | Pastelero | 540x700x1700 | 600x400 (Pastelera) |



Modelo GN



Modelo Pastelero

- Construido en acero inox ANSI 304 18/10.
- Desmontable.
- 4 ruedas giratorias 125 mm \varnothing (2 con freno).
- 15 niveles con 89 mm de separación.

Carro universal

| Código | Modelo | Medidas (mm) | Niveles |
|----------|--------|--------------|---------------|
| F0261201 | SIMPLE | 510x640x1690 | 12 niveles |
| F0261101 | DOBLE | 930x640x1690 | 12+12 niveles |



- Construido en acero inox ANSI 304 18/10.
- 4 ruedas giratorias 125 mm \varnothing (2 con freno).
- Dimensión máxima de bandeja: 530x370 mm.
- Espacio entre niveles: 112 mm.

Estanterías modulares



Sin tornillería, sistema de montaje con anclajes que permite ahorrar tiempo de instalación

- Homologadas con la certificación NF de higiene alimentaria.
- Facilidad de montaje mediante anclajes.
- Diseñadas especialmente para su colocación en cámaras frigoríficas.
- Parrillas autoventiladas y lavables en lavavajillas.
- 2 profundidades: 370 y 470 mm. Medida gastronorm.
- 2 alturas:
 - 1700 mm (10 alturas regulables cada 150 mm).
 - 2000 mm (12 alturas regulables cada 150 mm).



Detalle pieza anclaje



Ruedas opcionales con freno



- Construidas totalmente en polipropileno alimenticio de alta densidad.
- Fácil montaje.
- Parrillas de ancho 370 y 470 mm.

BUFFET Y CATERING

*Buffet and Catering • Buffet et de restauration
Buffet e Ristorazione • Buffet-Catering*



Buffet 5 Estrellas / Classic

Destinado a buffets modernos y de tendencia. 2 acabados: **5 estrellas** lacado blanco, de alta resistencia, es ideal para ambientes lujosos y de alto nivel.

Classic en wengué. Ambos han sido realizados con materiales certificados, adecuados a los alimentos, y de fácil mantenimiento y limpieza. Todos aquellos elementos destinados a mantener el calor, están protegidos por una placa de acero, y se caracterizan por su cierre a fricción.

BUFFET CALIENTE. Mantienen los alimentos a una temperatura óptima. Disponibles en versión tradicional (con hornillos inox adecuados para contener alcohol en gel) y opcional (con resistencia eléctrica regulable de 7 posiciones. 700 W). Todos los modelos incluyen: 1 cubeta baño maría GN 1/1 h110mm (bollería h20mm); 2 quemadores con soporte; 1 base alta en MDF con placa superior de protección inox 18/10.



BUFFET FRÍO. Mantienen los alimentos a baja temperatura (4 a 15°C). El enfriamiento puede alcanzarse con las bolsas gel (previo enfriamiento en el congelador) o con hielo. Base baja o expositores a 2 ó 3 alturas en MDF. Los modelos refrigerados incluyen 2 fondos perforados GN 1/2 PC y 2 gel pack 20x19 cm.

PINTI buffet MADE IN ITALY



Chafing Disch rectangular
Cierre fricción

| Referencia | Medidas (mm) |
|------------|--------------|
|------------|--------------|

| | |
|----------|-------------|
| 51135555 | 640x460x300 |
| 511B5555 | 640x460x300 |



Sopera 2 estaciones
Capacidad cubeta 5 L

| Referencia | Medidas (mm) |
|------------|--------------|
|------------|--------------|

| | |
|----------|-------------|
| 51135556 | 640x460x260 |
| 511B5556 | 640x460x260 |



Portaverduras 4 compartimentos
Cubeta GN 1/4 65 mm

| Referencia | Medidas (mm) |
|------------|--------------|
|------------|--------------|

| | |
|----------|-------------|
| 51132810 | 640x460x300 |
| 511B2810 | 640x460x300 |



Bandeja caliente para bollería
Con resistencia eléctrica

| Referencia | Medidas (mm) |
|------------|--------------|
|------------|--------------|

| | |
|----------|-------------|
| 51130930 | 640x460x390 |
| 511B0930 | 640x460x390 |



Bandeja refrigerada para fiambres

| Referencia | Medidas (mm) |
|------------|--------------|
|------------|--------------|

| | |
|----------|-------------|
| 51130950 | 640x460x300 |
| 511B0950 | 640x460x300 |



Bandeja refrigerada para yogurt
22 ud.

| Referencia | Medidas (mm) |
|------------|--------------|
|------------|--------------|

| | |
|----------|--------------|
| 51132900 | 640x460x12,2 |
| 511B2900 | 640x460x12,2 |



Bandeja refrigerada yogurt y verduras
3 cubetas 1/3 Policarbonato

| Referencia | Medidas (mm) |
|------------|--------------|
|------------|--------------|

| | |
|-----------|--------------|
| 51132840 | 640x460x12,2 |
| 511B32840 | 640x460x12,2 |



Bandeja refrigerada para jarras
Incluye 3 jarras

| Referencia | Medidas (mm) |
|------------|--------------|
|------------|--------------|

| | |
|----------|--------------|
| 51131A00 | 640x460x12,2 |
| 511B1A00 | 640x460x12,2 |



Bandeja refrigerada para 8 botellas

| Referencia | Medidas (mm) |
|------------|--------------|
|------------|--------------|

| | |
|----------|--------------|
| 51133700 | 640x460x12,2 |
| 511B3700 | 640x460x12,2 |



Bandeja refrigerada doble
2 bandejas GN 1/1

| Referencia | Medidas (mm) |
|------------|--------------|
|------------|--------------|

| | |
|----------|-------------|
| 51131055 | 590x460x460 |
| 511B1054 | 590x460x460 |



BUFFET NEUTRO. Mantenimiento neutro de la temperatura.



Bandeja para quesos
1 bandeja GN 1/1

| Referencia | Medidas (mm) |
|------------|--------------|
|------------|--------------|

| | |
|----------|-------------|
| 51130940 | 640x460x300 |
| 511B0940 | 640x460x300 |



Bandeja para el pan
Cesto polirattan GN 1/1

| Referencia | Medidas (mm) |
|------------|--------------|
|------------|--------------|

| | |
|----------|-------------|
| 51136900 | 640x460x370 |
| 511B6900 | 640x460x370 |



Bandeja para champagne
2 cubos 7 litros (22 cm)

| Referencia | Medidas (mm) |
|------------|--------------|
|------------|--------------|

| | |
|----------|-------------|
| 51132600 | 640x460x210 |
| 511B2600 | 640x460x210 |



Bandeja para cortar pan

| Referencia | Medidas (mm) |
|------------|--------------|
|------------|--------------|

| | |
|----------|-------------|
| 51136800 | 640x460x162 |
| 511B6800 | 640x460x162 |



Bandeja para fruta
2 bandejas GN 1/1

| Referencia | Medidas (mm) |
|------------|--------------|
|------------|--------------|

| | |
|----------|-------------|
| 51131056 | 590x460x330 |
| 511B1056 | 590x460x330 |



Presentador 3 pisos
3 bandejas GN 2/3 Refrigeradas

| Referencia | Medidas (mm) |
|------------|--------------|
|------------|--------------|

| | |
|----------|-------------|
| 51131058 | 380x730x630 |
| 511B1058 | 380x730x630 |

* Cúpula opcional

Dispensadores 5 Estrellas / Classic

Al servicio de la restauración moderna.



Dispensador zumos y bebidas 9,5 L
Tubo para hielo

| Referencia | Medidas (mm) |
|------------|--------------|
|------------|--------------|

| | |
|----------|-------------|
| 51135420 | 250x460x670 |
| 511B5420 | 250x460x670 |

Dispensador zumos y bebidas 4,5 L
Tubo para hielo

| Referencia | Medidas (mm) |
|------------|--------------|
|------------|--------------|

| | |
|----------|-------------|
| 51135413 | 250x460x600 |
| 511B5413 | 250x460x600 |



Dispensador doble zumos y bebidas 4,5 L
Tubo para hielo

| Referencia | Medidas (mm) |
|------------|--------------|
|------------|--------------|

| | |
|----------|-------------|
| 51135416 | 250x460x600 |
| 511B5416 | 250x460x600 |



Dispensador de cereales 8 L
Simple

| Referencia | Medidas (mm) |
|------------|--------------|
|------------|--------------|

| | |
|----------|-------------|
| 51139818 | 250x460x660 |
| 511B9818 | 250x460x660 |



Dispensador de cereales 8 L
Doble

| Referencia | Medidas (mm) |
|------------|--------------|
|------------|--------------|

| | |
|----------|-------------|
| 51139819 | 510x460x660 |
| 511B9819 | 510x460x660 |



Dispensador bebidas calientes 8 L
Con resistencia eléctrica

| Referencia | Medidas (mm) |
|------------|--------------|
|------------|--------------|

| | |
|----------|-------------|
| 51139527 | 250x460x610 |
| 511B9527 | 250x460x610 |

Base para 36 cuencos Ø 6 cm

| Referencia | Medidas (mm) |
|------------|--------------|
|------------|--------------|

| | |
|----------|-------------|
| 51130799 | 190x100x260 |
| 9715B799 | 190x100x260 |

Base para 24 cuencos Ø 12 cm

| Referencia | Medidas (mm) |
|------------|--------------|
|------------|--------------|

| | |
|----------|-------------|
| 51130798 | 190x100x260 |
| 9715B798 | 190x100x260 |



PINTIbuffet
MADE IN ITALY

BUFFET
Y CATERING

Buffet y Catering

Línea Buffet Cubic

Cubos, estantes y bandejas que forman composiciones modulares, cómodas y funcionales. Original y versátil. Múltiples combinaciones posibles. Madera con tratamiento hidrófugo especial. En blanco o negro. Combinables. Presentaciones en buffet elegantes y originales. Fácil limpieza.



Conjunto
2 cubos con tapa + 1 travesaño de 100 cm
+ 1 presentador 6 bols + 6 bols melamina

Referencia **Medidas (cm)**

P905.506 141x49x17



Conjunto
2 cubos con tapa + 1 travesaño de 50 cm +
1 presentador 4 bols + 4 bols melamina

Referencia **Medidas (cm)**

P905.504 90x49x17



Conjunto
2 cubos con tapa + 1 travesaño de 80 cm +
2 presentadores 4 bols + 4 bols melamina

Referencia **Medidas (cm)**

P905.508 121x49x17



Conjunto
4 cubos con tapa + 1 travesaño de 100 cm + 1 presentador
6 bols + 6 bols melamina + 1 estante de 100 cm

Referencia **Medidas (cm)**

P905.516 141x49x31,5



Dispensador zumos 6 L

Referencia **Medidas (cm)**

P904.800 23x39x49



Conjunto
4 cubos con tapa + 1 estante 100 cm +
estante estrecho 100 cm

Referencia **Medidas (cm)**

P905.400 141,5x31,5x35



Conjunto
6 cubos con tapa + 1 estante ancho 100 cm + estante estrecho
100 cm + 1 estante ancho 80 cm + 1 estante estrecho 80 cm

Referencia **Medidas (cm)**

P905.410 141,5x121,5x31,5



Expositor GN 2/3 3 niveles
Incluye 3 cubetas inox GN 2/3 2 cm

Referencia **Medidas (cm)**

P904.790 65x38x59



Conjunto
4 cubos con tapa + 1 travesaño 100 cm +
2 bandejas presentación 40x40

Referencia **Medidas (cm)**

P905.300 141x39x31,5



Conjunto
6 cubos con tapa + 1 travesaño 100 cm + 2 bandejas
presentación 60x40 cm + un estante estrecho 100 cm

Referencia **Medidas (cm)**

P905.340 141x60x46

Conjunto
2 cubos con tapa + 1 travesaño 100 cm +
2 bandejas presentación 60x40

Referencia **Medidas (cm)**

P905.320 141x60x17



Conjunto
2 cubos con tapa + 1 travesaño 50 cm + 1 bandeja
presentación 60x40 cm + kit completo dispensador zumos

Referencia **Medidas (cm)**

P905.200 121x39x48





Bandeja porta cubiertos

| Referencia | Medidas (mm) |
|------------|--------------|
|------------|--------------|

| | |
|------------|------------|
| P904.780 | 539x335x77 |
| * Apilable | |



Bandeja servicio y presentación GN 1/1

| Referencia | Medidas (mm) |
|------------|--------------|
|------------|--------------|

| | |
|------------|------------|
| P904.711 | 600x400x65 |
| * Apilable | |



Bandeja presentación

| Referencia | Medidas (mm) |
|------------|--------------|
|------------|--------------|

| | |
|------------|------------|
| P904.740 | 400x400x65 |
| * Apilable | |



Bandeja servicio y presentación

| Referencia | Medidas (mm) |
|------------|--------------|
|------------|--------------|

| | |
|------------|------------|
| P904.760 | 600x400x65 |
| * Apilable | |



Servilletero y dispensador bolsas té y azúcar

| Referencia | Medidas (mm) |
|------------|--------------|
|------------|--------------|

| | |
|----------|---------|
| P904.720 | 220x220 |
| P904.725 | 220x220 |



Enfriador botellas buffet

| Referencia | Medidas (mm) |
|------------|--------------|
|------------|--------------|

| | |
|----------|-------------|
| P904.155 | 570x370x145 |
|----------|-------------|

Mesita buffet GN 1/1 + taco madera

| Referencia | Medidas (mm) |
|------------|--------------|
|------------|--------------|

| | |
|----------|-------------|
| P904.850 | 530x325x120 |
|----------|-------------|



Mesita buffet baja + taco madera

| Referencia | Medidas (mm) |
|------------|--------------|
|------------|--------------|

| | |
|----------|-------------|
| P904.810 | 325x220x120 |
| P904.820 | 325x220x165 |
| P904.890 | 325x220x210 |

Buffet cubiertos

| Referencia | Medidas (mm) |
|------------|--------------|
|------------|--------------|

| | |
|-----------|-------------|
| P904.150 | 570x370x255 |
| P904.150W | 570x370x255 |



Buffet pan

| Referencia | Medidas (mm) |
|------------|--------------|
|------------|--------------|

| | |
|-----------|-------------|
| P904.145 | 570x370x145 |
| P904.145W | 570x370x145 |



Enfriador botellas caja madera

| Referencia | Medidas (mm) |
|------------|--------------|
|------------|--------------|

| | |
|----------|-------------|
| P904.157 | 325x265x150 |
|----------|-------------|



Buffet melamina

| Referencia | Medidas (mm) |
|------------|--------------|
|------------|--------------|

| | |
|-----------|-------------|
| P904.160 | 570x370x145 |
| P904.160W | 570x370x145 |

Buffet triple

| Referencia | Medidas (mm) |
|------------|--------------|
|------------|--------------|

| | |
|-----------|-------------|
| P904.113 | 570x370x310 |
| P904.113W | 570x370x310 |



Buffet quesos

| Referencia | Medidas (mm) |
|------------|--------------|
|------------|--------------|

| | |
|-----------|-------------|
| P904.140 | 570x370x310 |
| P904.140W | 570x370x310 |



Buffet estandar

| Referencia | Medidas (mm) |
|------------|--------------|
|------------|--------------|

| | |
|-----------|-------------|
| P904.165 | 570x370x310 |
| P904.165W | 570x370x310 |



Soporte pincho estante

| Referencia | Medidas (mm) |
|------------|--------------|
|------------|--------------|

| | |
|----------|---------|
| P904.360 | 448x182 |
| P904.361 | 748x182 |



Bandeja cuadrada pinchos

| Referencia | Medidas (mm) |
|------------|--------------|
|------------|--------------|

| | |
|----------|------------|
| P904.351 | 220x215x40 |
|----------|------------|



Bandeja GN pinchos

| Referencia | Medidas (mm) |
|------------|--------------|
|------------|--------------|

| | |
|----------|------------|
| P904.350 | 530x325x77 |
|----------|------------|

Buffet Compact



Perfecto para Bed & Breakfast, Agriturismo, Garni, Hoteles y Hoteles Boutique. Ahorro de espacio, versátil y elegante son sólo algunos de los adjetivos para describir esta línea especialmente creado para el desayuno, que puede caber fácilmente en muchos lugares diferentes.

- Las bases y los marcos son de madera revestida que son resistentes a los arañazos, a los impactos y resistente a las manchas.
- Las cloches PET son elegantemente transparentes, apilables y resistentes al impacto del uso diario.



Estación dulce salado

1 estructura + 2 cestas GN 1/3 + 3 cúpulas + 2 cubetas GN 1/2 inox + 1 pack gel refrigerante

| Referencia | Medidas (mm) |
|------------|------------------|
| 51602400 | 500/1260x420x330 |



Estación refrigerada multiuso 3 huecos

1 estructura + cubeta PP + 1 pack gel refrigerante

| Referencia | Medidas (mm) |
|------------|--------------|
| 51600900 | 405x160x120 |



Estación bol refrigerado multiuso
1 estructura + 1 tapa Ø 23 cm abatible + tapa perforada 24 cm + 1 bol vidrio 23 + 1 rejilla + cúpula Ø 24 cm.

| Referencia | Medidas (mm) |
|------------|------------------|
| 51602400 | 500/1260x420x330 |



Cajón multiusos 4 departamentos

| Referencia | Medidas (mm) |
|------------|--------------|
| 51604600 | 300x300x60 |



Servilletero

| Referencia | Medidas (mm) |
|------------|--------------|
| 51604300 | 215x215x65 |

PINTIbuffet
MADE IN ITALY

Retermalizadores y calentadores

Retermalizadores

Calentar y mantener alimentos a la temperatura deseada. Incluso permite calentar comidas salidas directamente del refrigerador en menos de 90 minutos.



Estilo Retro

Calienta con agua la comida fría hasta una temperatura deseada en menos de 90 minutos.

El cuerpo exterior no se calienta durante el uso.

| Referencia | Capacidad | Medidas (cm) |
|------------|-----------|--------------|
|------------|-----------|--------------|

| | | |
|----------|---------|-------------|
| 7217810 | 6,6 L | Ø 41,9x34,3 |
| 72178835 | 6,6 L | Ø 41,9x34,3 |
| 7217850 | 6,6 L | Ø 41,9x34,3 |
| 7217855 | 6,6 L | Ø 41,9x34,3 |
| 7217860 | 6,6 L | Ø 41,9x34,3 |
| 7217310 | 10,10 L | Ø 41,9x34,3 |
| 7217335 | 10,10 L | Ø 41,9x34,3 |
| 7217350 | 10,10 L | Ø 41,9x34,3 |
| 7217355 | 10,10 L | Ø 41,9x34,3 |
| 7217360 | 10,10 L | Ø 41,9x34,3 |



Mirage 3D inducción

Calentamiento por inducción (sin agua).

Reduce el coste energético.

Control de temperatura fácil y seguro.

Tiempos de rethermalización rápidos.

Arranque inmediato, sin precalentar.

| Referencia | Capacidad | Medidas (cm) |
|------------|-----------|--------------|
|------------|-----------|--------------|

| | | |
|----------|--------|------------------|
| 7470210 | 6,6 L | Ø 30,3x34,2x17,6 |
| 7074240 | 6,6 L | Ø 30,3x34,2x17,6 |
| 74110210 | 10,4 L | Ø 35,3x34,2x17,6 |
| 74110240 | 10,4 L | Ø 35,3x34,2x17,6 |



Cazillos Ergogrip

Acero inoxidable.

Asas revestidas de plástico que resisten 82°C

| Referencia | Capacidad | Medidas (cm) |
|------------|-----------|--------------|
|------------|-----------|--------------|

| | | |
|---------|----------|-----------|
| 4980322 | 88,7 ml | Ø 7,3x33 |
| 4980422 | 118,3 ml | Ø 7,9x33 |
| 4980622 | 177,4 ml | Ø 8,6x33 |
| 4980822 | 236,6 ml | Ø 10,3x36 |

Calentadores

Mantener calientes las comidas preparadas.



Ollas

475 W - 10,10 L

| Referencia | Medidas (cm) |
|------------|--------------|
|------------|--------------|

| | |
|------------------------|-----------|
| HIERRO ESMALTADO 69037 | Ø 34,5x36 |
| ACERO INOXIDABLE 69038 | Ø 34,5x36 |

Calentador

800 W - 11 L

| Referencia | Medidas (cm) |
|------------|--------------|
|------------|--------------|

| | |
|-------|---------|
| 69267 | Ø 33x32 |
|-------|---------|



Olla

550 W - 80°C - 10 L

| Referencia | Medidas (cm) |
|------------|--------------|
|------------|--------------|

| | |
|-------|---------|
| 11901 | Ø 38x36 |
| 11902 | Ø 38x36 |

Chafing Dish



Chafer Inducción Intrigue

Tapas removibles con bisagra de cierre lento.

3 ángulos de apertura, cerrada, 45° o 90°.

Tapa y cubeta con sistema antigoteo, mantienen la condensación fuera del alimento.



Chafing Dish redondo

| Referencia | Descripción | Medidas (cm) |
|------------|-----------------------|----------------|
| 46123 | Tapa acero inoxidable | 39,4x8 - 5,8 L |
| 46125 | Tapa cristal | 39,4x8 - 5,8 L |



Chafing Dish cuadrado

| Referencia | Descripción | Medidas (cm) |
|------------|-----------------------|------------------------|
| 46132 | Tapa acero inoxidable | 39,2x39,2x4,12 - 5,8 L |
| 46134 | Tapa cristal | 39,2x39,2x4,12 - 5,8 L |



Soporte Chafing

| Referencia | Descripción |
|------------|-------------|
| 46114 | Redondo |
| 46113 | Cuadrado |



Fuente interior redonda

| Referencia | Descripción | Medidas (cm) |
|------------|--------------------|--------------|
| 46130 | Porcelana | 39,4x71 |
| 49130 | Porcelana dividida | 39,4x71 |
| 49131 | Acero inoxidable | 39,4x71 |

Fuente interior cuadrada

| Referencia | Descripción | Medidas (cm) |
|------------|--------------------|--------------|
| 46136 | Porcelana | 39,4x38,8x52 |
| 49136 | Porcelana dividida | 39,4x38,8x52 |
| 46137 | Acero inoxidable | 39,4x38,8x52 |



Calentador eléctrico universal
Encaja en el orificio para el combustible estándar

Referencia

46110

Mirage calentadores de inducción

Diseño atractivo y sutil, se pueden conectar hasta 3 placas a la vez.

Parte superior de cristal templado negro.

Con 4 ajustes de potencia.

Indicadores luminosos LED en el panel de control.

Placa inducción mantenedora Mirage
300 W

| Referencia | Medidas (cm) |
|------------|---------------|
| 595027502 | 40,6x40,6x9,8 |





Tapa con descenso amortiguado para un cierre suave.
Tapa extraíble verticalmente para su limpieza.
Las gotas de condensación retornan a la cubeta.
Disponibilidad de aro complementario para el empleo de placa de inducción.



Chafing Dish GN 1/1

| Referencia | Descripción | Medidas (cm) |
|------------|-------------|--------------|
|------------|-------------|--------------|

| | | |
|-------|----------|------------------|
| 69091 | Completo | 47x59,5x25 - 9 L |
| 69099 | Cuerpo | 47x59,5x25 - 9 L |
| 69089 | Soporte | 47x59,5x25 - 9 L |



Chafing Dish GN 2/3

| Referencia | Descripción | Medidas (cm) |
|------------|-------------|--------------|
|------------|-------------|--------------|

| | | |
|-------|----------|--------------------|
| 69092 | Completo | 43x46x25,5 - 5,5 L |
| 69095 | Cuerpo | 43x46x25,5 - 5,5 L |
| 69087 | Soporte | 43x46x25,5 - 5,5 L |



Chafing sopa

| Referencia | Descripción | Medidas (cm) |
|------------|-------------|--------------|
|------------|-------------|--------------|

| | | |
|-------|----------|------------------|
| 69098 | Completo | Ø 45x38 - 11,6 L |
| 69100 | Cuerpo | Ø 45x38 - 11,6 L |
| 69097 | Soporte | Ø 45x38 - 11,6 L |



Chafing redondo

| Referencia | Descripción | Medidas (cm) |
|------------|-------------|--------------|
|------------|-------------|--------------|

| | | |
|-------|----------|----------------|
| 69101 | Completo | 46x53x25 - 6 L |
| 69096 | Cuerpo | 46x53x25 - 6 L |
| 69097 | Soporte | 46x53x25 - 6 L |



Chafing Dish GN 1/2

| Referencia | Descripción | Medidas (cm) |
|------------|-------------|--------------|
|------------|-------------|--------------|

| | | |
|---------|-----------------|-------------------|
| 69093 | Completo | 32,5x46x25,5 - 4L |
| 69094 | Cuerpo | 32,5x46x25,5 - 4L |
| 69088 | Soporte | 32,5x46x25,5 - 4L |
| R69094A | Aro placa | 32,5x46x25,5 - 4L |
| 69139 | Placa inducción | 32,5x46x25,5 - 4L |



Accesorios

Placa inducción para
69091/69092/69098/69101

Referencia

69131

Aro completo para inducción

Referencia

Para 69091/69092 R69099B

Para 69098/69101 R69100B

Salsera 12x23x4 cm R69099C



Chafing eléctricos



Eco GN 1/1
900 W

| Referencia | Medidas | Capacidad |
|------------|-------------|-----------|
| 12232 | 63x36x29 cm | 9 L |



Eco redondo
500 W

| Referencia | Medidas | Capacidad |
|------------|------------|-----------|
| 12221 | Ø 36x25 cm | 6,8 L |



Elite GN 1/1
900 W

| Referencia | Medidas | Capacidad |
|------------|-------------|-----------|
| 12360 | 67x47x45 cm | 14 L |

Chafing económicos



| Referencia | Medidas | Capacidad |
|------------|-------------|-----------|
| P379.065 | 65x35x34 cm | 9,5 L |



| Referencia | Medidas | Capacidad |
|------------|-------------|-----------|
| P379.500 | 65x35x32 cm | 9 L |



| Referencia | Medidas | Capacidad |
|------------|-------------|-----------|
| P387.065 | 65x38x39 cm | 9,5 L |

Chafing bebidas calientes



Royal

| Referencia | Medidas | Capacidad |
|------------|-------------|-----------|
| 11667 | 28x28x65 cm | 12 L |



Happy Hour

| Referencia | Medidas | Capacidad |
|------------|-----------------|-----------|
| 11672 | 31x33,6x54,5 cm | 10,5 L |



Complementos

Placa eléctrica Chafing
bebidas
500 W

Referencia

12287

Calentadores eléctricos
para chafing
700 W

Referencia

Con regulador 69002
Sin regulador 69012



Contenedor
combustible

Referencia

69006



Cubo Gel
Etanol

| Referencia | Capacidad |
|------------|-----------|
| 69109 | 4 kg |



Bidón
Metanol

| Referencia | Capacidad |
|------------|-----------|
| 69109 | 4 kg |



Lata Gel combustible
Etanol

| Referencia | Capacidad |
|------------|-----------|
| 69108 | 225 gr |



Lámparas calentamiento infrarrojos



Estación Buffet trinchante
Bombilla infrarrojos, blanca 250 W

Referencia **Medidas (cm)**

46671 60x55x66



Tabla de corte
Color negro

Referencia **Medidas (cm)**

25154 54x42x1,27



Lámpara cable extensible

Referencia **Medidas** **Potencia**

69266 24x24x35 cm 275 W



Referencia **Medidas** **Potencia**

Doble 69061 36x45x61 cm 550 W
Simple 69361 34x33x56 cm 275 W



Referencia **Medidas** **Potencia**

Simple 69263 79x31x23 cm 275 W
Doble 69264 76x36x36 cm 550 W



Placa calentamiento eléctrica
400 W - Rango Temp 0° - 80°C

Referencia **Medidas (cm)**

69045 36x45x61



Luxe inox

Referencia **Medidas** **Potencia**

2 ranuras 69162 32x18x19 cm 850 W
4 ranuras 69164 32x26x19 cm 1400 W



Tostador horizontal

Referencia **Medidas** **Potencia**

1 piso 69172 50x25x38 cm 2400 W
2 pisos 69173 50x25x38 cm 3600 W



Fuentes chocolate

Referencia **Medidas (cm)**

Torre 18 cm 69318 Ø 16x30
Torre 38 cm 69319 Ø 23x54,5



Tostador cinta

Referencia **Medidas** **Potencia**

PRODUCCIÓN 150 h 69065 53x37x40 cm 1340 W
PRODUCCIÓN 300 h 69066 53x45x40 cm 2240 W

Dispensadores de Bebidas



Airpot eléctrico
Agua-café-Leche Capacidad: 5,20 L

Referencia Medidas (cm)

69475 Ø 28x37



Chocolatera eléctrica
Capacidad: 5 L

Referencia Medidas (cm)

N4905 Ø 48,5x32



Samovar eléctrico
Capacidad: 3 L Incluye tetera 0,60 L

Referencia Medidas (cm)

N5062 Ø 21x47

Top Fresh

Enfrían por abajo y por arriba con acumuladores de frío, manteniendo el zumo y la leche frío y seco.



Botella cristal enfriadora

Referencia Medidas (cm)

1,4 L 10762 Ø 16x27



10771 10772 10773 10774

Botellas policarbonato

Medidas (cm) Capacidad

Ø 16x27 1,6 L

| Referencia |
|------------|
| 10771 |
| 10772 |
| 10773 |
| 10774 |



Dispensadores leche
Cuba Porcelana

Referencia Medidas (cm)

4 Litros 10850 31x21x42
Cuba acero inoxidable
3 Litros 10830 31x21x42
5 Litros 10750 31x21x42

Mixto zumo leche

6+5 Litros 10760 42x32x52



Dispensador de zumo

Referencia Medidas (cm)

4 Litros 10800 21x32x43
6 Litros 10700 23x35x52
2x6 Litros 10720 42x32x52



Jarras acrílicas
Con tubo para hielo

Referencia Capacidad

10770 3 L
10769 2,4 L



Referencia Capacidad

10776 2,5 L
10775 2 L

Dispensador de cereales

Inox Star

Económico, con tubo refrigerante para el hielo
Cuba SAN.



Dispensador de zumo

| Referencia | Medidas (cm) |
|------------|--------------|
|------------|--------------|

| | | |
|------------|-------|----------|
| 8 Litros | 10795 | 36x26x55 |
| 2x6 Litros | 10810 | 36x52x55 |

Fresh & Easy

Acero inoxidable y cuba en policarbonato.
Tapa especial para mantener los cereales frescos, fácil de usar.
Económico.



| Referencia | Medidas | Capacidad |
|------------|---------|-----------|
|------------|---------|-----------|

| | | | |
|--------|-------|---------------|---------|
| SIMPLE | 11805 | 22x17,5x52 cm | 4,5 L |
| DOBLE | 11807 | 22x35x52 cm | 2x4,5 L |



Dispensadores de bebidas
Incluye difusor frío y base

| Referencia | Capacidad |
|------------|-----------|
|------------|-----------|

| | |
|----|-------|
| 75 | 9,5 L |
| 85 | 19 L |



Incluye difusor frío

| Referencia | Capacidad |
|------------|-----------|
|------------|-----------|

| | | |
|-------------|---------|-------|
| DISPENSADOR | BDG1000 | 9,5 L |
| BASE | BDGTUB | 9,5 L |



Good Morning

Set madera con 2 botes cierre hermético 2 L

| Referencia | Medidas (cm) |
|------------|--------------|
|------------|--------------|

| | |
|-------|-------|
| 13965 | 43x17 |
| 14965 | 43x17 |



| Referencia | Medidas | Capacidad |
|------------|---------|-----------|
|------------|---------|-----------|

| | | |
|---------|--------------|-----|
| B898028 | Ø 22x29,5 cm | 8 L |
| B898029 | Ø 19x24 cm | 5 L |



| Referencia | Medidas | Capacidad |
|------------|---------|-----------|
|------------|---------|-----------|

| | | |
|---------|-------------|-----|
| B898007 | 18x18x32 cm | 8 L |
| B898008 | 15x15x26 cm | 4 L |



Classic

Acero inoxidable 18/10 y cuba en policarbonato. Tapa hermética. Calidad extra.

| Referencia | Medidas | Capacidad |
|------------|---------|-----------|
|------------|---------|-----------|

| | | | |
|--------|-------|---------------|-------|
| SIMPLE | 11833 | 32x26,5x68 cm | 8 L |
| DOBLE | 11834 | 32x50x68 cm | 2x8 L |

Rotation

Giratorio. Acero inoxidable 18/10 y cuba en policarbonato. Tapa hermética. Calidad extra.



| Referencia | Medidas | Capacidad |
|------------|---------|-----------|
|------------|---------|-----------|

| | | |
|-------|------------|---------|
| 11970 | Ø 38x54 cm | 3x4,5 L |
|-------|------------|---------|

Cereal Bar

Jarra SAN 1,5 L con tapa acero inoxidable. Stand acrílico con 2 alturas para presentaciones.



| Referencia | Medidas | Capacidad |
|------------|---------|-----------|
|------------|---------|-----------|

| | | |
|-------|---------------|---------|
| 11971 | 26x17x28,5 cm | 2x1,5 L |
| 11972 | 26x17x32,5 cm | 2x1,5 L |
| 11973 | 38x17x28,5 cm | 3x1,5 L |
| 11974 | 38x17x32,5 cm | 3x1,5 L |



Soporte en acero inoxidable
3 Bols vidrio 3 tapas acrílica con bisagra

| Referencia | Medidas | Bol |
|--------------|-------------|---------|
| BIG 11892 | 50x50x18 cm | Ø 23 cm |
| LITTLE 11893 | 30x30x14 cm | Ø 14 cm |

Boles opcionales

| Referencia | Bol |
|------------|---|
| 83702 | Ø 23 cm <input type="checkbox"/> |
| 83703 | Ø 23 cm <input checked="" type="checkbox"/> |
| 83700 | Ø 14 cm <input type="checkbox"/> |
| 83701 | Ø 14 cm <input checked="" type="checkbox"/> |



Sunday

Soporte metálico
Bols vidrio 23 cm con tapa policarbonato con bisagra

| Referencia | Medidas (cm) |
|------------|--------------|
|------------|--------------|

| | | |
|--------|-------|----------|
| 1 bol | 11794 | Ø 24x17 |
| 3 bols | 11795 | 61x24x35 |



Soporte en acero inoxidable
4 Bols con tapa acrílica con bisagra

| Referencia | Medidas | Bol |
|------------|---------|-----|
|------------|---------|-----|

| | | |
|-------|-------------|---------|
| 11958 | 39x31x55 cm | Ø 23 cm |
| 11498 | 30x30x48 cm | Ø 14 cm |



Soporte en acero inoxidable
6 Bols sin tapa

| Referencia | Medidas | Bol |
|------------|---------|-----|
|------------|---------|-----|

| | | |
|-------|-------------|---------|
| 11599 | 39x31x55 cm | Ø 23 cm |
| 11499 | 30x30x48 cm | Ø 14 cm |

Dispensadores



Rack para Bols
Metálico

| Referencia | Medidas | Bol |
|------------|---------|-----|
|------------|---------|-----|

| | | | |
|--------|-------|----------------|-------------|
| MINI | 11980 | Ø 14x25,5 cm | 36xØ 6 cm |
| MEDIUM | 11990 | Ø 17x25,5 cm | 36xØ 7,5 cm |
| MAXI | 11992 | Ø 17,5x36,5 cm | 15xØ 14 cm |



Multi-Rack

Acero inoxidable 18/10 Bols SAN

| Referencia | Medidas |
|------------|---------|
|------------|---------|

| | | |
|-----------|-------|-------------|
| 2 alturas | 11442 | 19x24x28 cm |
| 3 alturas | 11444 | 19x24x41 cm |
| 4 alturas | 11451 | 19x31x53 cm |

Soportes



Star
Metálico

Referencia **Medidas (Altura)**

| | |
|-------|-------|
| 33260 | 8 cm |
| 33261 | 12 cm |
| 33262 | 18 cm |



King

Metal cromado.
Antideslizante en puntas de brazos.
Alta calidad. Base para reposar cucharas.

Referencia **Medidas**

| | |
|-------|------------|
| 03622 | Ø 15x14 cm |
| 03623 | Ø 15x21 cm |



Multi
Metálico

Medida: 18x18 cm

Referencia **Medidas (Altura)**

| | |
|-------|-------|
| 33250 | 8 cm |
| 33251 | 10 cm |
| 33252 | 18 cm |

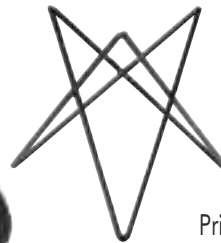

Prisma
Metálico

Medida: 26 cm

Referencia **Medidas (Altura)**

| | |
|-------|---------|
| 33272 | 10,5 cm |
| 33273 | 20 cm |

Wood
Madera
2 posiciones
Medidas: 20x20x17,5

Referencia

| | |
|-------|--|
| 33280 |  |
| 33281 |  |

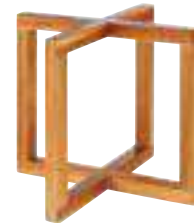

Soporte Weck
Metal cromado

Referencia **Medidas**

| | | |
|-----------|-------|------------|
| 6 Tarros | 33247 | Ø 22x33 cm |
| 12 Tarros | 33246 | Ø 22x59 cm |

Referencia **Medidas** **Capacidad**

| | | |
|-------|------------|--------|
| 82370 | Ø 6x5,5 cm | 0,08 L |
| 82371 | Ø 6x8 cm | 0,16 L |



Para bols Float 83916/83917



Para bols Float 83914/83915



Soporte Float
Metal cromado

Referencia **Medidas**

| | | |
|-------|-------|-----------------|
| SMALL | 33241 | 55,5x19x15,5 cm |
| BIG | 33242 | 39x39x17 cm |

Baskets



15326 Cesta negra

| Referencia | Medidas (cm) |
|------------|--------------|
| 15326 | Ø 21/15x21 |



15332 Cesta/soporte plata brillo

| Referencia | Medidas (cm) |
|------------|--------------|
| 15331 | Ø 15/21x10,5 |
| 15332 | Ø 21/20x20 |



15335 Cesta/soporte oro mate

| Referencia | Medidas (cm) |
|------------|--------------|
| 15334 | Ø 15/21x10,5 |
| 15335 | Ø 21/20x20 |



15322 Cesta/soporte

| Referencia | Medidas (cm) |
|------------|--------------|
| 15320 | Ø 10,5/8x8 |
| 15324 | Ø 10,5/8x8 |
| 15322 | Ø 10,5/8x8 |

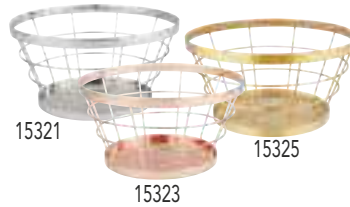

15321 Cesta/soporte

| Referencia | Medidas (cm) |
|------------|--------------|
| 15321 | Ø 21/15x21 |
| 15325 | Ø 21/15x21 |
| 15323 | Ø 21/15x21 |

Asia +

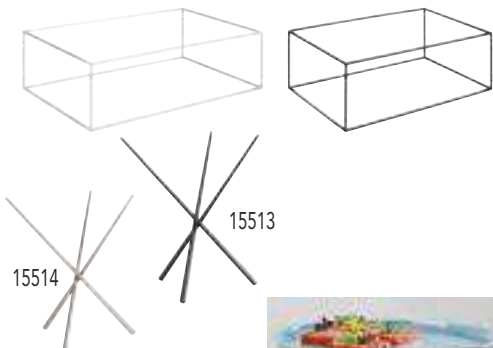

15513 Buffet Stand

| Referencia | Medidas (cm) |
|--------------|----------------|
| GN 1/1 15501 | 53x32x16,2 |
| GN 1/2 15502 | 32,5x26,5x16,2 |
| GN 2/3 15503 | 32,5x17,5x32,5 |

| Referencia | Medidas (cm) |
|--------------|----------------|
| GN 1/1 15504 | 53x32x16,2 |
| GN 1/2 15505 | 32,5x26,5x16,2 |
| GN 2/3 15506 | 32,5x17,5x32,5 |

15514 Buffet Stand

| Referencia | Medidas (cm) |
|------------|--------------|
| 15513 | Ø 20x16,5 |
| 15514 | Ø 20/16,5 |



| Referencia | Referencia | Referencia | Tapa | Medidas (cm) |
|------------|------------|------------|-------|--------------|
| 15400 | 15408 | 15416 | | Ø 7,5 |
| 15401 | 15409 | 15417 | | Ø 9,5 |
| 15402 | 15410 | 15418 | | Ø 13 |
| 15403 | 15411 | 15419 | 15340 | Ø 16 |
| 15404 | 15412 | 15420 | 15341 | Ø 20 |
| 15405 | 15413 | 15421 | 15342 | Ø 24 |
| 15406 | 15414 | 15422 | 15343 | Ø 26,5 |
| 15407 | 15414 | 15423 | 15344 | Ø 32,5 |



15509 Buffet Stand

| Referencia | Medidas (cm) |
|------------|--------------|
| 15509 | Ø 21x20 |
| 15512 | Ø 21/20 |



15511 Buffet Stand

| Referencia | Medidas (cm) |
|------------|--------------|
| 15508 | Ø 21x10,5 |
| 15511 | Ø 21/10,5 |

| Referencia | Referencia | Referencia | Medidas (cm) |
|------------|------------|------------|--------------|
| 15424 | 15429 | 15434 | Ø 11 |
| 15425 | 15430 | 15435 | Ø 16 |
| 15426 | 15431 | 15436 | Ø 19,5 |
| 42427 | 15432 | 15437 | Ø 24 |
| 15428 | 15433 | 15438 | Ø 28 |





Tapas
Policarbonato

| Referencia | Medidas (cm) |
|------------|--------------|
|------------|--------------|

| | |
|--------------|---------------|
| GN 1/1 11042 | 53x32x9,5 |
| GN 1/2 11041 | 32,5x26,5x9,5 |



Tapa
Poliestileno

| Referencia | Pomo | Medidas |
|------------|------|---------|
|------------|------|---------|

| | | |
|-------|--------------|--------------|
| 06510 | Transparente | Ø 30x11 cm |
| 06511 | Negro | Ø 30x11 cm |
| 06512 | Cromado | Ø 30x11 cm |
| 06515 | Transparente | Ø 33x12,5 cm |
| 06516 | Negro | Ø 33x12,5 cm |
| 06517 | Cromado | Ø 33x12,5 cm |



Buffet set Caterer
Bandeja acero inoxidable 18/10

| Referencia | Medidas (cm) |
|------------|--------------|
|------------|--------------|

| | |
|-------|------------|
| 11195 | 53x32x10,5 |
|-------|------------|



Base tarta
Melamina

| Referencia | Medidas (cm) |
|------------|--------------|
|------------|--------------|

| | |
|-------|--|
| 00468 | Ø 31x4 <input type="checkbox"/> |
| 00469 | Ø 31x4 <input checked="" type="checkbox"/> |

Buffet set Hochtapler
Bandeja acero inoxidable 18/10

| Referencia | Medidas (cm) |
|------------|--------------|
|------------|--------------|

| | |
|-------|------------|
| 11302 | 53x32x10,5 |
|-------|------------|



Pedestal tarta

Melamina Medida: Ø 31 cm

| Referencia | Medidas (Altura) |
|------------|------------------|
|------------|------------------|

| | |
|-------|-------|
| 83890 | 8 cm |
| 83891 | 16 cm |



Tapas GN
SAN

| Referencia | Pomo | Medidas |
|------------|------|---------|
|------------|------|---------|

| | | |
|--------------|------------------|-------------|
| GN 1/1 11026 | Cerrada | 53x33x20 cm |
| GN 1/1 11027 | Apertura frontal | 53x33x20 cm |
| GN 1/1 11028 | Apertura lateral | 53x33x20 cm |
| GN 1/2 11021 | Cerrada | 33x18x17 cm |
| GN 1/2 11022 | Apertura frontal | 33x18x17 cm |



Pedestal tarta

Acero inoxidable 18/10 Medida: Ø 34,5 cm

| Referencia | Medidas (Altura) |
|------------|------------------|
|------------|------------------|

| | |
|-------|---------|
| 00466 | 13,5 cm |
|-------|---------|



Tapa Roll Top
SAN

| Referencia | Pomo | Medidas |
|------------|---------|------------|
| 18387 | Dorado | Ø 38x20 cm |
| 18388 | Cromado | Ø 38x20 cm |
| 18380 | Dorado | Ø 50x26 cm |
| 18383 | Cromado | Ø 50x26 cm |



Set Buffet Bret
Base madera haya tratada
Pies antideslizantes

| Referencia | Medidas (cm) |
|------------|--------------|
| 00866 | Ø 50 |



Set Rolltop
Base politileno
Pies antideslizantes

| Referencia | Medidas (cm) |
|------------|--------------|
| 09081 | Ø 38x24 |



Set Rolltop
Base acero inoxidable 18/10
Pies antideslizantes

| Referencia | Medidas (cm) |
|------------|--------------|
| 09080 | Ø 38x24 |
| 09099 | Ø 50x28 |



Tapa Roll Top
Policarbonato Temperatura -30°C +120°C

| Referencia | Pomo | Medidas |
|------------|------|---------|
|------------|------|---------|

| | | | |
|--------|-------|---------|---------------|
| GN 1/1 | 11008 | Dorado | 53x32x19 cm |
| GN 1/1 | 11010 | Cromado | 53x32x19 cm |
| GN 1/1 | 12008 | Dorado | 53x32x26,5 cm |
| GN 1/1 | 12010 | Cromado | 53x32x26,5 cm |



Base madera Bret
Base madera haya tratada
Pies antideslizantes

| Referencia | Medidas (cm) |
|------------|--------------|
| 00865 | 58x38x2,5 |



Base buffet Top Fresh
Base acero inoxidable 18/10
Pies antideslizantes
2 acumuladores de frío

| Referencia | Medidas (cm) |
|------------|--------------|
| 11510 | 61x38x8 |

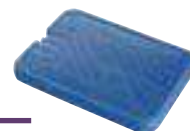

Expositor
Metálico

| Referencia | Medidas (cm) |
|------------|--------------|
| 33231 | 37,5x37,5x50 |



Bandejas
Melamina

| Referencia | Medidas (cm) |
|------------|--------------|
| 83407 | 21x21 |
| 83406 | 26,5x26,5 |
| 83405 | 37x37 |

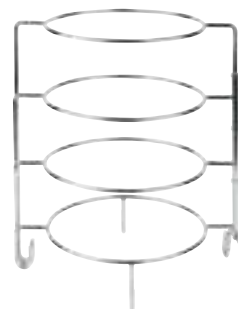

Expositor extensible
Metálico
Para 4 platos max 31 cm

| Referencia | Medidas (cm) |
|------------|--------------|
| 33225 | Ø 34x37 |



Buffet Ladder
Metálico

| Referencia | GN | Medidas |
|--------------|-----|-----------------|
| LITTLE 11526 | 1/3 | 31,5x32x48 cm |
| LITTLE 11527 | 1/2 | 31,5x41,5x48 cm |
| BIG 11528 | 1/1 | 31,5x56x66 cm |

Gastronorm Super Shapes



- Formas exclusivas que destacan la presentación de las comidas.
- Elegante presentación de las comidas con una mínima inversión.
- Capacidad para reducir los desperdicios de comida.
- Cubetes apilables entre sí.
- Acero inoxidable serie 300, espesor 0,8 mm.



Super Pan® Super Shapes Ovalada

| NSF | Referencia | Medidas | Capacidad |
|-----|----------------|----------------|-----------|
| | GN 1/1 3101015 | 53x32,5x5,1 cm | 3,7 L |
| | GN 1/1 3101020 | 53x32,5x6,5 cm | 4,6 L |
| | GN 1/1 3101040 | 53x32,5x10 cm | 7,8 L |



Super Pan® Super Shapes Hexágono

| NSF | Referencia | Medidas | Capacidad |
|-----|----------------|----------------|-----------|
| | GN 1/1 3101220 | 53x32,5x6,5 cm | 5 L |
| | GN 1/1 3101240 | 53x32,5x10 cm | 8,8 L |



Super Pan® Super Shapes Reniforme

| NSF | Referencia | Medidas | Capacidad |
|-----|----------------|----------------|-----------|
| | GN 1/1 3101120 | 53x32,5x8,5 cm | 4,8 L |

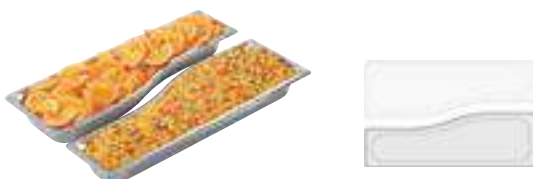

Super Pan® Super Shapes Wild Pan larga

| NSF | Referencia | Medidas | Capacidad |
|-----|----------------|----------------|-----------|
| | GN 2/4 3100020 | 53x16,5x8,5 cm | 3,5 L |
| | GN 2/4 3100040 | 53x16,5x8,9 cm | 4,8 L |



Super Pan® Super Shapes Óvalo

| NSF | Referencia | Medidas | Capacidad |
|-----|----------------|------------------|-----------|
| | GN 1/2 3102015 | 26,5x32,5x5,1 cm | 1,6 L |
| | GN 1/2 3102020 | 26,5x32,5x6,5 cm | 2,1 L |
| | GN 1/2 3102040 | 26,5x32,5x10 cm | 3,5 L |

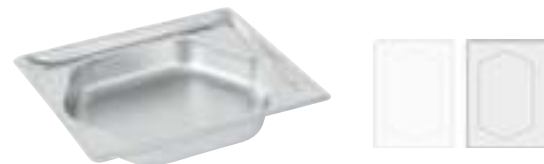

Super Pan® Super Shapes Hexágono

| NSF | Referencia | Medidas | Capacidad |
|-----|----------------|------------------|-----------|
| | GN 1/2 3102220 | 26,5x32,5x6,5 cm | 2,1 L |
| | GN 1/2 3102240 | 26,5x32,5x10 cm | 3,6 L |



Super Pan® Super Shapes Reniforme

| NSF | Referencia | Medidas | Capacidad |
|-----|----------------|------------------|-----------|
| | GN 1/2 3102120 | 26,5x32,5x6,5 cm | 2,1 L |



Barra adaptadora

| NSF | Referencia | |
|-----|------------|---|
| | 75015 | Barra adaptadora para fuentes Wild Pan, 3100020 y 3100040 |
| | 75013 | Barra adaptadora para fuentes Wild Pan - Fuentes cortas y Wild Pan, 3100220, 3100240, 3100320, 3100321, 3100340 y 3100341 |



Super Pan® Super Shapes Wild Pan corta

| NSF | Referencia | Medidas | Capacidad |
|-----|----------------|------------------|-----------|
| | GN 1/2 3100220 | 26,5x32,5x6,5 cm | 3,9 L |
| | GN 1/2 3100240 | 26,5x32,5x10 cm | 6,1 L |



Super Pan® Super Shapes Óvalo

| NSF | Referencia | Medidas | Capacidad |
|-----|----------------|-----------------|-----------|
| | GN 1/3 3103040 | 17,6x32,5x10 cm | 2,1 L |



Super Pan® Super Shapes Wild Pan externa

| NSF | Referencia | Medidas | Capacidad |
|-----|----------------|------------------|-----------|
| | GN 1/3 3100320 | 17,6x32,5x8,5 cm | 2,5 L |
| | GN 1/3 3100340 | 17,6x32,5x10 cm | 3,6 L |



Super Pan® Super Shapes Wild Pan interna

| NSF | Referencia | Medidas | Capacidad |
|-----|----------------|------------------|-----------|
| | GN 1/3 3100321 | 17,6x32,5x8,5 cm | 2,5 L |
| | GN 1/3 3100341 | 17,6x32,5x10 cm | 3,6 L |

Bols doble pared

Construcción aislante de doble pared, conserva la temperatura de los alimentos.

| Referencia | Medidas |
|---------------|-----------------|
| 46587 + color | Ø 11,4x7,6 cm |
| 46590 + color | Ø 18,4x10,3 cm |
| 46591 + color | Ø 24x13 cm |
| 46592 + color | Ø 30x16,5 cm |
| 46569 + color | Ø 35x17,5 cm |
| 47619 + color | 14x14x7 cm |
| 47632 + color | 18x18x8,7 cm |
| 47634 + color | 21,6x21,6x13 cm |
| 47635 + color | 25,8x25,8x13 cm |
| 47637 + color | 30x30x15 cm |



Miramar Buffet

Batería de cocina acero inoxidable

Miramar® para presentación.

- La batería pasa directamente de la cocina a su buffet en el mismo recipiente.
- Variedad de utensilios de cocina para todo tipo de comidas.





Fuentes decorativas y plantillas Miramar®

- Plantillas disponibles en acero inoxidable y color negro.
- Diversidad de formas con bordes decorados.



Plantilla agujeros redondo grande y pequeño



| Referencia | Medidas | Color |
|------------|---------|-------|
|------------|---------|-------|

| | | |
|----------------|---------|--|
| GN 1/1 8242014 | 536x324 | Acero inoxidable  |
| GN 1/1 8242010 | 536x324 | Negro  |



Plantilla agujero oval grande

| Referencia | Medidas | Color |
|------------|---------|-------|
|------------|---------|-------|

| | | |
|----------------|---------|--|
| GN 1/1 8242314 | 536x324 | Acero inoxidable  |
| GN 1/1 8242310 | 536x324 | Negro  |



Plantilla agujeros redondo grande y pequeño

| Referencia | Medidas | Color |
|------------|---------|-------|
|------------|---------|-------|

| | | |
|----------------|---------|--|
| GN 1/1 8242414 | 536x324 | Acero inoxidable  |
|----------------|---------|--|



Plantilla agujeros redondos grandes



| Referencia | Medidas | Color |
|------------|---------|-------|
|------------|---------|-------|

| | | |
|----------------|---------|--|
| GN 1/1 8242514 | 536x324 | Acero inoxidable  |
|----------------|---------|--|



Plantilla agujero redondo grande



| Referencia | Medidas | Color |
|------------|---------|-------|
|------------|---------|-------|

| | | |
|----------------|---------|--|
| GN 1/1 8242614 | 536x324 | Acero inoxidable  |
| GN 1/1 8242610 | 536x324 | Negro  |



Plantilla agujero oval grande



| Referencia | Medidas | Color |
|------------|---------|-------|
|------------|---------|-------|

| | | |
|----------------|---------|--|
| GN 1/1 8242714 | 536x324 | Acero inoxidable  |
| GN 1/1 8242710 | 536x324 | Negro  |



Plantilla para fuente

| Referencia | Medidas | Color |
|------------|---------|-------|
|------------|---------|-------|

| | | |
|----------------|---------|--|
| GN 1/1 8242814 | 536x324 | Acero inoxidable  |
| GN 1/1 8242810 | 536x324 | Negro  |



Plantilla para fuente

| Referencia | Medidas | Color |
|------------|---------|-------|
|------------|---------|-------|

| | | |
|----------------|---------|------------------|
| GN 1/1 8242914 | 536x324 | Acero inoxidable |
|----------------|---------|------------------|



Plantilla para fuente

| Referencia | Medidas | Color |
|------------|---------|-------|
|------------|---------|-------|

| | | |
|----------------|---------|------------------|
| GN 1/1 8243014 | 536x324 | Acero inoxidable |
|----------------|---------|------------------|



Plantilla agujeros ovales grande y pequeño

| Referencia | Medidas | Color |
|------------|---------|-------|
|------------|---------|-------|

| | | |
|----------------|---------|------------------|
| GN 1/1 8243114 | 536x324 | Acero inoxidable |
|----------------|---------|------------------|



Plantilla agujeros redondos medianos

| Referencia | Medidas | Color |
|------------|---------|-------|
|------------|---------|-------|

| | | |
|----------------|---------|------------------|
| GN 1/1 8243214 | 536x324 | Acero inoxidable |
| GN 1/1 8243210 | 536x324 | Negro |



Plantilla agujeros redondos grande y mediano

| Referencia | Medidas | Color |
|------------|---------|-------|
|------------|---------|-------|

| | | |
|----------------|---------|------------------|
| GN 1/1 8243314 | 536x324 | Acero inoxidable |
|----------------|---------|------------------|



| Referencia | Medidas | Capacidad |
|------------|---------|-----------|
|------------|---------|-----------|

| | | |
|-------|-------------|-------|
| 43910 | 20x20x95 cm | 2,9 L |
| 43911 | 24x24x11 cm | 4,8 L |



| Referencia | Medidas | Capacidad |
|------------|---------|-----------|
|------------|---------|-----------|

| | | |
|-------|--------------|-------|
| 49420 | 25,5x19x5 cm | 1,7 L |
| 49412 | 30,5x22x5 cm | 2,5 L |



| Referencia | Medidas | Capacidad |
|------------|---------|-----------|
|------------|---------|-----------|

| | | |
|-------|------------|-------|
| 49416 | 20x20x5 cm | 1,2 L |
| 49413 | 26x26x5 cm | 4,8 L |



| Referencia | Medidas | Capacidad |
|------------|---------|-----------|
|------------|---------|-----------|

| | | |
|-------|------------|-------|
| 49417 | 20x20x6 cm | 1,7 L |
| 49424 | 26x26x6 cm | 2,9 L |



| Referencia | Medidas | Capacidad |
|------------|---------|-----------|
|------------|---------|-----------|

| | | |
|-------|--------------|-------|
| 49418 | 30x30x9,5 cm | 4,9 L |
| 49428 | 32x32x9 cm | 6 L |



| Referencia | Medidas | Capacidad |
|------------|---------|-----------|
|------------|---------|-----------|

| | | |
|-------|------------|-----|
| 49425 | 30x30x9 cm | 6 L |
|-------|------------|-----|



| Referencia | Medidas | Capacidad |
|------------|---------|-----------|
|------------|---------|-----------|

| | | |
|-------|--------------|-------|
| 49430 | 14x14x7 cm | 0,9 L |
| 49414 | 16x16x9,5 cm | 1,9 L |



| Referencia | Medidas | Capacidad |
|------------|---------|-----------|
|------------|---------|-----------|

| | | |
|-------|------------|-------|
| 49435 | 29x24x5 cm | 2,6 L |
| 49433 | 37x30x5 cm | 4,4 L |



| Referencia | Medidas | Capacidad |
|------------|---------|-----------|
|------------|---------|-----------|

| | | |
|-------|-------------|-------|
| 49431 | 36x28x10 cm | 6,6 L |
|-------|-------------|-------|

Porcelana Buffet



Cubetas Gastro Hotel
Porcelana

Referencia Medidas

| | | |
|--------|--------|------------------|
| GN 1/1 | 005796 | 53x32,5x6,5 cm |
| GN 2/4 | 616344 | 53x16,5x6,5 cm |
| GN 2/3 | 005465 | 35,2x32,5x6,5 cm |
| GN 1/2 | 005800 | 32,5x26,5x6,5 cm |
| GN 1/3 | 638794 | 32,5x17,6x6,5 cm |

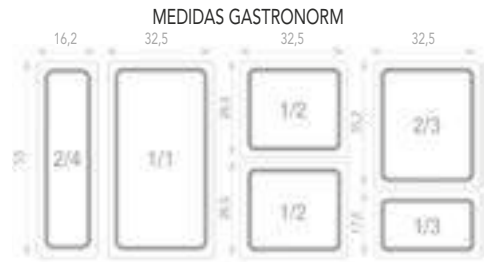

Revolution 2 Colección

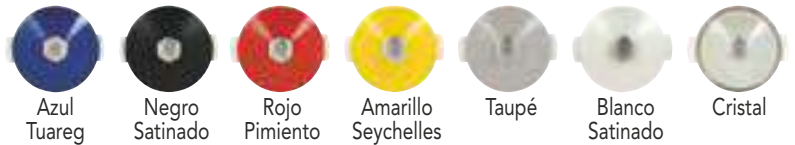

Cocotte baja

| Referencia | Medidas | Capacidad |
|------------|--------------|-----------|
| 649862 | Ø 28x13,5 cm | 3,6 L |
| 649863 | Ø 28x13,5 cm | 3,6 L |
| 649861 | Ø 28x13,5 cm | 3,6 L |
| 649589 | Ø 28x13,5 cm | 3,6 L |
| 649860 | Ø 28x13,5 cm | 3,6 L |
| 649864 | Ø 28x13,5 cm | 3,6 L |
| 649865 | Ø 28x13,5 cm | 3,6 L |

Cocotte oval

| Referencia | Medidas | Capacidad |
|------------|-----------------|-----------|
| 649993 | 23x19,5x14 cm | 2 L |
| 649994 | 23x19,5x14 cm | 2 L |
| 649991 | 23x19,5x14 cm | 2 L |
| 649989 | 23x19,5x14 cm | 2 L |
| 649990 | 23x19,5x14 cm | 2 L |
| 649922 | 23x19,5x14 cm | 2 L |
| 649870 | 32,5x26,5x16 cm | 3,5 L |
| 649871 | 32,5x26,5x16 cm | 3,5 L |
| 649869 | 32,5x26,5x16 cm | 3,5 L |
| 649867 | 32,5x26,5x16 cm | 3,5 L |
| 649868 | 32,5x26,5x16 cm | 3,5 L |
| 649872 | 32,5x26,5x16 cm | 3,5 L |
| 649873 | 32,5x26,5x16 cm | 3,5 L |

Cocotte Redonda

| Referencia | Medidas | Capacidad |
|------------|---------|-----------|
| 649817 | Ø 23 cm | 2,4 L |
| 649816 | Ø 23 cm | 2,4 L |
| 649815 | Ø 23 cm | 2,4 L |
| 649813 | Ø 23 cm | 2,4 L |
| 649814 | Ø 23 cm | 2,4 L |
| 649818 | Ø 23 cm | 2,4 L |
| 649820 | Ø 23 cm | 2,4 L |
| 649854 | Ø 26 cm | 3,4 L |
| 649855 | Ø 26 cm | 3,4 L |
| 649853 | Ø 26 cm | 3,4 L |
| 649851 | Ø 26 cm | 3,4 L |
| 649852 | Ø 26 cm | 3,4 L |
| 648856 | Ø 26 cm | 3,4 L |
| 648857 | Ø 26 cm | 3,4 L |

Tajin

| Referencia | Medidas | Capacidad |
|------------|--------------|-----------|
| 649877 | Ø 32x21,5 cm | 3 L |
| 649876 | Ø 32x21,5 cm | 3 L |

Porta tapas acero inoxidable

| Referencia | Medidas |
|------------|----------------------|
| 644282 | 30,5x23x37,5 cm Alto |
| 645051 | 30,5x23x37,5 cm Bajo |

Fuentes gastronorm GN



Fuente GN 1/2
Medida: 32,5x26,5 cm

| Referencia | Fondo |
|------------|-------|
|------------|-------|

| | |
|---------|--|
| B885001 | 6,5 cm <input type="checkbox"/> |
| B885161 | 6,5 cm <input checked="" type="checkbox"/> |
| B885209 | 10 cm <input type="checkbox"/> |
| B885214 | 10 cm <input checked="" type="checkbox"/> |

Fuente GN 2/3
Medida: 35x32 cm

| Referencia | Fondo |
|------------|-------|
|------------|-------|

| | |
|---------|---------------------------------|
| B885004 | 6,5 cm <input type="checkbox"/> |
|---------|---------------------------------|

Fuente GN 1/6
Medida: 17,6x16 cm

| Referencia | Fondo |
|------------|-------|
|------------|-------|

| | |
|---------|---|
| B885006 | 6,5 cm <input type="checkbox"/> |
| B885212 | 6,5 cm <input type="checkbox"/> |
| B885217 | 10 cm <input checked="" type="checkbox"/> |

Melamina

Fuente GN 1/1
Medida: 53x32 cm

| Referencia | Fondo |
|------------|-------|
|------------|-------|

| | |
|---------|--|
| B885000 | 6,5 cm <input type="checkbox"/> |
| B885160 | 6,5 cm <input checked="" type="checkbox"/> |
| B885208 | 10 cm <input type="checkbox"/> |
| B885213 | 10 cm <input checked="" type="checkbox"/> |

Fuente GN 2/4
Medida: 53x16,2 cm

| Referencia | Fondo |
|------------|-------|
|------------|-------|

| | |
|---------|---------------------------------|
| B885002 | 6,5 cm <input type="checkbox"/> |
|---------|---------------------------------|

Fuente GN 1/3
Medida: 32,5x17,6 cm

| Referencia | Fondo |
|------------|-------|
|------------|-------|

| | |
|---------|---|
| B885003 | 6,5 cm <input type="checkbox"/> |
| B885210 | 10 cm <input type="checkbox"/> |
| B885215 | 10 cm <input checked="" type="checkbox"/> |

Fuente GN 1/4
Medida: 26,5x16,2 cm

| Referencia | Fondo |
|------------|-------|
|------------|-------|

| | |
|---------|---|
| B885005 | 6,5 cm <input type="checkbox"/> |
| B885211 | 10 cm <input type="checkbox"/> |
| B885216 | 10 cm <input checked="" type="checkbox"/> |



Bayahive

| Referencia | GN |
|------------|----|
|------------|----|

| | |
|----------|-----|
| B885260R | 1/1 |
| B885261R | 1/2 |
| B885264R | 2/4 |
| B885262R | 1/3 |
| B885263R | 1/4 |



Bayahive Wood

| Referencia | GN |
|------------|----|
|------------|----|

| | |
|----------|-----|
| B885265R | 1/1 |
| B885266R | 1/2 |
| B885269R | 2/4 |
| B885267R | 1/3 |
| B885268R | 1/4 |



Bayahive Wood

| Referencia | GN |
|------------|----|
|------------|----|

| | |
|---------|-----|
| B885280 | 1/1 |
| B885281 | 1/2 |
| B885284 | 2/4 |
| B885282 | 1/3 |
| B885283 | 1/4 |
| B885285 | 1/6 |



Bayahive Wood

| Referencia | GN |
|------------|----|
|------------|----|

| | |
|---------|-----|
| B885286 | 1/1 |
| B885287 | 1/2 |
| B885290 | 2/4 |
| B885288 | 1/3 |
| B885289 | 1/4 |
| B885291 | 1/6 |



| Referencia | Medidas | Capacidad |
|------------|---------|-----------|
|------------|---------|-----------|

| | | | |
|--------|-------|------------------|---|
| GN 1/2 | 84000 | 32,5x26,5x8,5 cm | 3,5 L <input type="checkbox"/> |
| GN 2/4 | 84002 | 53,5x16,2x8,5 cm | 3,2 L <input type="checkbox"/> |
| GN 1/4 | 84004 | 26,5x16,2x8,5 cm | 1,4 L <input type="checkbox"/> |
| | 84006 | 25x25x8,5 cm | 2,8 L <input type="checkbox"/> |
| GN 1/2 | 84001 | 32,5x26,5x8,5 cm | 3,5 L <input checked="" type="checkbox"/> |
| GN 2/4 | 84003 | 53,5x16,2x8,5 cm | 3,2 L <input checked="" type="checkbox"/> |
| GN 1/4 | 84005 | 26,5x16,2x8,5 cm | 1,4 L <input checked="" type="checkbox"/> |
| | 84007 | 25x25x8,5 cm | 2,8 L <input checked="" type="checkbox"/> |



Stone Art

| Referencia | Medidas | GN |
|------------|------------------|-----|
| 84519 | 53x32,5x1,5 cm | 1/1 |
| 84520 | 32,5x26,5x1,5 cm | 1/2 |
| 84521 | 32,5x17,6x1,5 cm | 1/3 |
| 84522 | 53x16,2x1,5 cm | 2/4 |

La Vida

| Referencia | Medidas | GN |
|------------|------------------|-----|
| 84144 | 53x32,5x1,5 cm | 1/1 |
| 84145 | 32,5x26,5x1,5 cm | 1/2 |
| 84146 | 53x16,2x1,5 cm | 2/4 |
| 84147 | 53x32,5x1,5 cm | 1/1 |
| 84148 | 32,5x26,5x1,5 cm | 1/2 |
| 84149 | 53x16,2x1,5 cm | 2/4 |

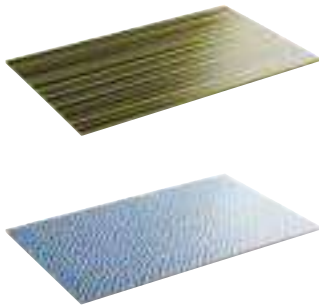

Bandeja rectangular

| Referencia | Referencia | Medidas | GN |
|------------|------------|------------------|-----|
| 15439 | 15444 | 53x32,5x1,5 cm | 1/1 |
| 15440 | 15445 | 32,5x26,5x1,5 cm | 1/2 |
| 15441 | 15446 | 32,5x17,6x1,5 cm | 1/3 |
| 15442 | 15447 | 26,5x16,2x1,5 cm | 1/4 |
| 15443 | 15448 | 53x16,2x1,5 cm | 2/4 |



Bandeja rectangular

| Referencia | Referencia | Medidas | GN |
|------------|------------|----------------|-----|
| 15449 | 15455 | 53x32,5x3 cm | 1/1 |
| 15450 | 15456 | 32,5x26,5x3 cm | 1/2 |
| 15451 | 15457 | 32,5x17,6x3 cm | 1/3 |
| 15452 | 15458 | 26,5x16,2x3 cm | 1/4 |
| 15453 | 15459 | 35,4x32,5x3 cm | 2/3 |
| 15454 | 15460 | 53x16,2x3 cm | 2/4 |



| Referencia | Referencia | Referencia | Referencia | Medidas | GN |
|------------|------------|------------|------------|------------------|-----|
| NEGRA | BLANCA | PIZARRA | MÁRMOL | | |
| 84195 | 84185 | 83955 | 84360 | 53x32,5x1,5 cm | 1/1 |
| 84196 | 84186 | 83956 | 84361 | 32,5x26,5x1,5 cm | 1/2 |
| 84197 | 84187 | 83957 | 84362 | 32,5x17,6x1,5 cm | 1/3 |
| 84198 | 84188 | 83958 | 84363 | 26,5x16,2x1,5 cm | 1/4 |
| 84199 | 84189 | 83971 | 84364 | 53x32,5x1,5 cm | 2/4 |



Espejos GN

| Referencia | Medidas | GN |
|------------|----------------|-----|
| 00961 | 53x32x3 cm | 1/1 |
| 00962 | 32,5x26,5x3 cm | 1/2 |
| 00963 | 32,5x17,6x3 cm | 1/3 |
| 00964 | 53x16,2x3 cm | 2/4 |



Superbox



Caja madera

| Referencia | Referencia | Medidas | GN |
|------------|------------|-------------------|-----|
| 11620 | 11626 | 55,5x35x10,5 cm | 1/1 |
| 11623 | 11629 | 55,5x18,5x10,5 cm | 2/4 |
| 11621 | 11627 | 35x29x10,5 cm | 1/2 |
| 11622 | 11628 | 29x18,5x10,5 cm | 1/4 |



Cajas Madera haya GN



Alzadores

| Referencia | Medidas (Altura) | GN |
|------------|------------------|-----|
| 3030 | 10 cm | 1/1 |
| 3031 | 18 cm | 1/1 |



Cajas

| Referencia | Medidas | GN |
|------------|-----------------|-----|
| 3000 | 53x32,5x10 cm | 1/1 |
| 3001 | 32,5x26,5x10 cm | 1/2 |
| 3002 | 32,5x17,6x10 cm | 1/3 |
| 3003 | 26,5x16,2x10 cm | 1/4 |
| 3004 | 53x16,2x10 cm | 2/4 |

Campana metacrilato

| Referencia | GN |
|------------|-----|
| 3030 | 1/1 |



Melamina



La Vida

| Referencia | Medidas |
|------------|-----------|
| 84161 | Ø 32 cm |
| 84170 | Ø 40,5 cm |
| 84165 | Ø 32 cm |
| 84168 | Ø 40,5 cm |
| 84174 | Ø 32 cm |
| 84172 | Ø 40,5 cm |

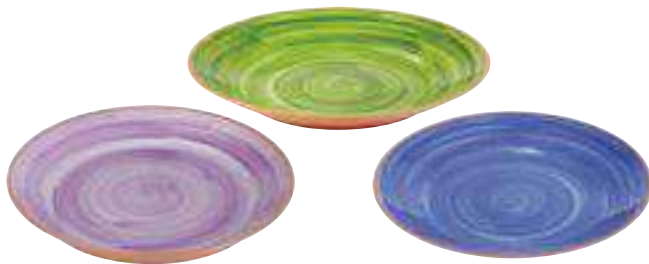

Frida

| Referencia | Referencia | Referencia | Medidas | Capacidad | GN |
|------------|------------|------------|------------------|-----------|-----|
| 84555 | 84556 | 84557 | 17,6x10,8x5,5 cm | 0,5 L | 1/9 |
| 84558 | 84559 | 84560 | 16,5x16,5x5,5 cm | 0,85 L | |
| 84561 | 84562 | 84563 | 25x25x5,5 cm | 2,65 L | 1/9 |
| 84564 | 84565 | 84566 | 53x16,2x7,5 cm | 3,65 L | 1/9 |



Perpignan

| Referencia | Referencia | Referencia | Medidas |
|------------|------------|------------|-----------------|
| B885228 | B885218 | B885223 | 30x21x12 cm |
| B885229 | B885219 | B885224 | 21,5x17,5x10 cm |
| B885230R | B885220R | B885225R | 17x14x8 cm |
| B885231R | B885221R | B885226R | 15x12x7 cm |
| B885231R | B885222R | B885227R | 12x10x6 cm |

Soho

| Referencia | Referencia | Referencia | Medidas |
|------------|------------|------------|---------|
| B885292 | B885307 | B885295 | Ø 22x22 |
| B885293 | B885308 | B885296 | Ø 18x18 |
| B885294 | B885309 | B885297 | Ø 14x14 |



Pure

| Referencia | Medidas | Capacidad |
|------------|--------------|-----------|
| 84490 | Ø 5,5x4 cm | 0,02 L |
| 84491 | Ø 9,5x4,5 cm | 0,09 L |
| 84492 | Ø 12x6,5 cm | 0,3 L |
| 84493 | Ø 15x7,5 cm | 0,45 L |
| 84494 | Ø 20x10,5 cm | 1,25 L |

Bols Float
Melamina
Apilables



| Referencia | Referencia | Medidas | Capacidad |
|------------|------------|-----------|-----------|
| ● | ○ | | |
| 83901 | 83900 | Ø 5,5 cm | 0,03 L |
| 83903 | 83902 | Ø 9 cm | 0,15 L |
| 83905 | 83904 | Ø 13 cm | 0,45 L |
| 83907 | 83906 | Ø 15 cm | 0,7 L |
| 83909 | 83908 | Ø 20,5 cm | 1,9 L |

| Referencia | Referencia | Medidas | Capacidad |
|------------|------------|--------------|-----------|
| ● | ○ | | |
| 83910 | 83910 | 5,5x5,5 cm | 0,03 L |
| 83913 | 83912 | 9x9 cm | 0,16 L |
| 83915 | 83914 | 12,5x12,5 cm | 6 L |
| 83917 | 83916 | 19x19 cm | 9,5 L |
| 83919 | 83918 | 25x25 cm | 12 L |

Tapas Float

| Referencia | Medidas |
|------------|-----------|
| 83920 | Ø 20,5 cm |
| 83921 | 19x19 cm |
| 83922 | 25x25 cm |



Pure Color
Melamina

| Referencia | Referencia | Referencia | Referencia | Medidas |
|------------|------------|------------|------------|--------------|
| ○ | ● | ● | ● | |
| 83414 | 83466 | 83568 | 83569 | 9x9 cm |
| 83410 | 83467 | 83570 | 83571 | 12,5x12,5 cm |
| 83409 | 83468 | 83572 | 83573 | 19x19 cm |
| 83408 | 83469 | 83574 | 83575 | 25x25 cm |



Pure Bicolor
Melamina

| Referencia | Referencia | Referencia | Medidas |
|------------|------------|------------|--------------|
| ●○ | ○● | ●○ | |
| 84414 | 84415 | 84420 | 9x9 cm |
| 84410 | 84416 | 84421 | 12,5x12,5 cm |
| 84409 | 84417 | 84422 | 19x19 cm |
| 84408 | 84418 | 84423 | 25x25 cm |



Tapas SAN

| Referencia | Medidas |
|------------|----------|
| 83600 | 19x19 cm |
| 83601 | 25x25 cm |



Balance
Melamina

| Referencia | Referencia | Medidas | Capacidad |
|------------|------------|-----------|-----------|
| ○ | ● | | |
| 84040 | 85040 | Ø 14,5 cm | 0,4 L |
| 84041 | 85041 | Ø 21 cm | 1,5 L |
| 84042 | 85042 | Ø 24,5 cm | 2,5 L |
| 84043 | 85043 | Ø 30 cm | 5 L |



Ming
Melamina

| Referencia | Referencia | Referencia | Medidas |
|------------|------------|------------|---------------|
| ○ | ● | ● | |
| B885066 | | | 30x30x13,5 cm |
| B885067 | | B885177 | 25x25x11,4 cm |
| B885068 | | B885178 | 21x21x9,5 cm |
| B885069 | B885251 | B885179 | 15x15x13,5 cm |
| B885070R | B885252R | B885180R | 10x10x6 cm |
| B885071R | B885253R | B885181R | 8x8x4,5 cm |

Trattoria
Melamina

| Referencia | Referencia | Referencia | Medidas |
|------------|------------|------------|------------------|
| ○ | ● | ● | |
| B885054 | | B885361 | Ø 26x7,1x13,7 cm |
| B885055 | | B885362 | Ø 23x6,6x12,5 cm |
| B885056 | | B885363 | Ø 21x5,4x10,5 cm |
| B885101 | B885254R | | Ø 9x4,4 cm |





Natural
Melamina

| Referencia | Referencia | Referencia | Medidas |
|------------|------------|------------|------------|
| ○ | ● | ● | |
| 84083 | 84084 | 84085 | 40x18,5 cm |
| 84086 | 84087 | 84088 | 52x25 cm |



| Referencia | Referencia | Referencia | Medidas |
|------------|------------|------------|----------|
| ○ | ● | ● | |
| 83871 | 83872 | 83865 | 27x27 cm |
| 83444 | 83445 | 83446 | 34x34 cm |
| 83873 | 83874 | 83866 | 42x42 cm |



| Referencia | Referencia | Referencia | Medidas |
|------------|------------|------------|---------------|
| ○ | ● | ● | |
| 84080 | 84081 | 84082 | 40x18,5x10 cm |



| Referencia | Referencia | Referencia | Medidas |
|------------|------------|------------|----------|
| ○ | ● | ● | |
| 83435 | 83436 | 83437 | 36x16 cm |
| 83438 | 83439 | 83440 | 45x24 cm |
| 83441 | 83442 | 83443 | 53x29 cm |



Timber
Melamina

| Referencia | Medidas |
|------------|----------|
| 84266 | Ø 35 cm |
| 84267 | Ø 40 cm |
| 84268 | 44x25 cm |
| 84269 | 65x26 cm |
| 84256 | 70x26 cm |



| Referencia | Referencia | Referencia | Medidas |
|------------|------------|------------|-----------|
| ○ | ● | ● | |
| 83864 | 83863 | 83862 | 35,5x8 cm |



OAK
Melamina

| Referencia | Medidas |
|------------|----------|
| 84177 | Ø 35 cm |
| 84178 | 40x20 cm |
| 84179 | 48x20 cm |



Slate
Melamina

| Referencia | Medidas |
|------------|-----------|
| 84240 | Ø 18,5 cm |
| 84241 | Ø 23 cm |
| 84242 | Ø 33,5 cm |
| 84243 | Ø 37 cm |



Tapas
SAN

| Referencia | Medidas |
|------------|-----------|
| 15350 | Ø 16,5 cm |
| 15351 | Ø 20,5 cm |
| 06512 | Ø 30 cm |
| 06517 | Ø 33 cm |



Fusión
Melamina

| Referencia | Medidas | Capacidad |
|------------|-------------|-----------|
| 84022 | Ø 11x7 cm | 0,3 L |
| 84023 | Ø 17x8,5 cm | 1 L |
| 84024 | Ø 20x8 cm | 1,2 L |



| Referencia | Medidas |
|------------|-------------|
| 84025 | 23,5x7,5 cm |
| 84026 | 24,5x6,5 cm |



| Marone Melamina | | |
|--------------------|-------------|-----------|
| Referencia | Medidas | Capacidad |
| 84110 | Ø 14x6 cm | 0,3 L |
| 84111 | Ø 19x8 cm | 0,8 L |
| 84112 | Ø 21x8,5 cm | 1 L |
| 84113 | Ø 24x9,5 cm | 1,4 L |
| 84174 | Ø 30,5x6 cm | 2 L |



| Referencia | Medidas |
|------------|--------------|
| 84103 | 14,5x14,5 cm |



| Referencia | Medidas |
|------------|------------|
| 84104 | 22,5x15 cm |
| 84105 | 27,5x11 cm |



| Referencia | Medidas |
|------------|--------------|
| 84106 | 26,5x16,5 cm |



| Referencia | Medidas |
|------------|-------------|
| 84117 | 19,5x9,5 cm |
| 84118 | 39x16 cm |



| Referencia | Medidas |
|------------|--------------|
| 84119 | 32,5x23,5 cm |



| Referencia | Medidas | Capacidad |
|------------|----------------|-----------|
| 84100 | 25,5x14x5,5 cm | 0,4 L |
| 84101 | 36x19x8 cm | 0,9 L |



| Referencia | Medidas | Capacidad |
|------------|--------------|-----------|
| 84114 | 23,5x23,5 cm | 0,7 L |



| Referencia | Medidas | Capacidad |
|------------|-------------|-----------|
| 84115 | Ø 11x3,5 cm | 0,13 L |
| 84116 | Ø 14x4 cm | 0,2 L |



| Referencia | Medidas | Capacidad |
|------------|-------------|-----------|
| 84109 | Ø 11x5,5 cm | 0,2 L |



| Referencia | Medidas | Capacidad |
|------------|--------------|-----------|
| 84107 | Ø 8,5x2,5 cm | 0,05 L |
| 84108 | Ø 11,5x3 cm | 0,04 L |



| Zen Melamina | | | |
|-----------------|------------|-------------|-----------|
| Referencia | Referencia | Medidas | Capacidad |
| ○ 83928 | ● 83929 | Ø 31x8,5 cm | |



| Referencia | Referencia | Medidas | Capacidad |
|------------|------------|----------|-----------|
| ○ 83710 | ● 83712 | 21x21 cm | 1,4 L |



| Referencia | Referencia | Medidas | Capacidad |
|------------|------------|----------------|-----------|
| ○ 84354 | ● 84355 | Ø 22,5x12,5 cm | 0,8 L |



| Referencia | Referencia | Medidas | Capacidad |
|------------|------------|---------------|-----------|
| ○ 84348 | ● 84349 | Ø 10x7 cm | 0,08 L |
| 84350 | 84351 | Ø 12,5x8,5 cm | 0,15 L |
| 84352 | 84353 | Ø 16x7 cm | 0,3 L |



| Referencia | Referencia | Medidas |
|------------|------------|--------------|
| ○ 83938 | ● 83939 | 32,5x14x4 cm |



| Referencia | Referencia | Medidas |
|------------|------------|---------------|
| ○ 83742 | ● 83744 | 22,5x9,5x3 cm |



| Referencia | Referencia | Medidas |
|------------|------------|------------|
| ○ 83946 | ● 83947 | 9x7x2,5 cm |



| Referencia | Referencia | Medidas | Capacidad |
|------------|------------|------------------|-----------|
| ○ 84340 | ● 84341 | 7x7x2 cm | 0,03 L |
| 84342 | 84343 | 9x9x2,5 cm | 0,06 L |
| 84344 | 84345 | 13,5x13,5x4 cm | 0,2 L |
| 84346 | 84347 | 16,5x16,5x4,5 cm | 0,3 L |



| Referencia | Referencia | Medidas | Capacidad |
|------------|------------|----------------|-----------|
| ○ 83729 | ● 83731 | 18x10x3,5 cm | 0,1 L |
| 83733 | 83735 | 25x13,5x4 cm | 0,25 L |
| 83737 | 83739 | 30,5x17,5x5 cm | 0,6 L |



Teka
Melamina

| Referencia | Color | Medidas |
|------------|-------|--------------|
| B98235053 | Teka | 53x27x2 cm |
| B98235033 | Teka | 33x30x2 cm |
| B98235040N | Nogal | 50x19,5x2 cm |
| B98235040T | Teka | 50x19,5x2 cm |



Vinea
Melamina

| Referencia | Referencia | Referencia | Medidas |
|------------|------------|------------|--------------|
| B98234034M | B98234034C | B98234034P | 34x25x3 cm |
| B98234029M | B98234029C | B98234029P | 29x20x2,5 cm |
| B98234025M | B98234025C | B98234025P | 25x18x2,3 cm |
| B98234020M | B98234020C | B98234020P | 20x13x2 cm |

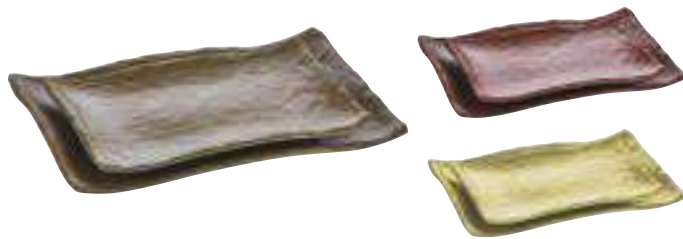

Terra
Melamina

| Referencia | Referencia | Referencia | Medidas |
|------------|------------|------------|--------------|
| B98230034M | B98230034C | B98230034T | 34x23x3,5 cm |
| B98230027M | B98230027C | B98230027T | 27,5x19x3 cm |

Terra
Melamina

| Referencia | Referencia | Referencia | Medidas |
|------------|------------|------------|-------------|
| B98226028M | B98226028C | B98226028T | Ø 28x11 cm |
| B98226023M | B98226023C | B98226023T | Ø 23x9,5 cm |



Terra Leaf
Melamina

| Referencia | Referencia | Referencia | Medidas |
|------------|------------|------------|------------------|
| B98231036M | B98231036C | B98231036T | 35,5x15,5x4,5 cm |

Terra Góndola
Melamina

| Referencia | Referencia | Referencia | Medidas |
|------------|------------|------------|----------------|
| B98232035M | B98232035C | B98232035T | 35,5x16x6 cm |
| B98232028M | B98232028C | B98232028T | 28,5x12,5x5 cm |





Terra Elips
Melamina

| Referencia | Referencia | Referencia | Medidas |
|------------|------------|------------|--------------|
| ● | ● | ● | |
| B98227023M | B98227023C | B98227023T | 23x14,5x4 cm |
| B98227018M | B98227018C | B98227018T | 18x11,5x3 cm |

Terra Elips
Melamina

| Referencia | Referencia | Referencia | Medidas |
|------------|------------|------------|---------------|
| ● | ● | ● | |
| B98225109M | B98225109C | B98225109T | 9x8,5x4 cm |
| B98225217M | B98225217C | B98225217T | 17,5x8,5x3 cm |
| B98225326M | B98225326C | B98225326T | 17,5x8,5x3 cm |



Ming
Melamina

| Referencia | Referencia | Medidas |
|------------|------------|------------------|
| ○ | ● | |
| B885057 | | 46,2x46,2x5,4 cm |
| B885058 | B885168 | 35,8x35,8x4,4 cm |
| B885059R | B885169R | 25,5x25,5x2,8 cm |
| B885060R | B885170R | 20,5x20,5x2,4 cm |
| B885061R | B885171R | 15,2x15,2x1,7 cm |
| B885062 | B885172 | 60x32x5 cm |
| B885063 | | 46x27x5 cm |
| B885064 | | 35,5x20,2x3,6 cm |
| B885065 | B885175 | 30,5x19x3 cm |



Degustación Troya
Melamina

| Referencia | Referencia | Referencia | Medidas |
|------------|------------|------------|--------------|
| ○ | ● | ● | |
| B885332R3 | B885336R3 | B885334R3 | Ø 13x2,5 cm |
| B885333R6 | B885337R6 | B885335R6 | Ø 10x2 cm |
| B885338R3 | B885342R3 | B885340R3 | 11x11x3,5 cm |
| B885339R6 | B885343R6 | B885341R6 | 9x9x3 cm |



Ramequín
Melamina

| Referencia | Referencia | Referencia | Medidas |
|------------|------------|------------|--------------|
| ○ | ● | ● | |
| B885045R | B885244R | B885247R | Ø 8,3x4,4 cm |
| B885046R | B885245R | B885248R | Ø 7,7x4,1 cm |
| B885047R | B885246R | B885249R | Ø 6,2x3,6 cm |



Oval Pétalo
Melamina

| Referencia | Referencia | Referencia | Medidas |
|------------|------------|------------|----------------|
| ○ | ● | ● | |
| B885323R3 | B885327R3 | B885325R3 | 16,5x12,5x3 cm |
| B885324R6 | B885328R6 | B885326R6 | 12x9x2 cm |







Góndola
Melamina

| Referencia | Referencia | Medidas |
|------------|------------|-----------------|
| ○ | ● | |
| B98213074B | B98213074N | 10,5x6,3x3,3 cm |



Boat
Melamina

| Referencia | Referencia | Referencia | Referencia | Referencia | Medidas |
|---|---|---|---|---|-------------|
|  |  |  |  |  | 14,5x4,5 cm |
| 84128 | 84140 | 84141 | 84142 | 84143 | |





Hong Kong
Melamina

| Referencia | Referencia | Referencia | Referencia | Medidas |
|---|---|---|---|-------------|
|  |  |  |  | 14,5x4,5 cm |
| 83486 | 83487 | 83424 | 83426 | |



Bowl degustación
Melamina

| Referencia | Referencia | Medidas |
|---|---|----------|
|  |  | 9x5,5 cm |
| B98213115B | B98213115N | |





Ming Hing
Melamina

| Referencia | Referencia | Medidas |
|--|--|-----------|
|  |  | 11x4,5 cm |
| 83842 | 83843 | |





Bowl salsas
Melamina

| Referencia | Referencia | Medidas |
|---|---|------------|
|  |  | Ø 8x3,5 cm |
| B9821308B | B9821308N | |
| B9281306B | B9281306N | Ø 6x2,5 cm |



Leaf
Melamina

| Referencia | Referencia | Referencia | Medidas |
|---|---|---|-----------|
|  |  |  | 10x4,5 cm |
| 83887 | 83888 | 83889 | |









Cocotte
Melamina

| Referencia | Referencia | Referencia | Medidas |
|---|---|---|-----------------|
|  |  |  | Oval 17x10x5 cm |
| B885364R1 | B885366R1 | B885365R1 | |
| B885367R1 | B885369R1 | B885368R1 | Ø 7x9x4 cm |



Cocotte
Melamina

| Referencia | Referencia | Referencia | Referencia | Referencia | Referencia | Referencia | Medidas | Capacidad |
|---|---|---|---|---|---|---|-------------|-----------|
|  |  |  |  |  |  |  | Ø 10x6,5 cm | 0,25 L |
| P23.800 | P23.801 | P23.802 | P23.803 | P23.804 | P23.805 | P23.806 | | Ø 14x8 cm |
| P23.810 | P23.811 | P23.812 | P23.813 | P23.814 | P23.815 | P23.816 | | |



Profi Line
Acero inoxidable 18/10
GN 1/1

| Referencia | Medidas |
|------------|----------|
| 11000 | 53x32 cm |



Redonda

| Referencia | Medidas |
|------------|---------|
| 11032 | Ø 32 cm |
| 11038 | Ø 38 cm |
| 11048 | Ø 48 cm |



Oval

| Referencia | Medidas |
|------------|----------|
| 11023 | 50x36 cm |
| 11024 | 60x41 cm |
| 11025 | 70x46 cm |



GN 1/1 Apilable

| Referencia | Medidas |
|------------|----------|
| 11300 | 53x32 cm |



Pizarra Natural GN 1/1 Apilable

| Referencia | Medidas |
|------------|----------|
| 00966 | 53x32 cm |

Essen
Acero inoxidable 18/10
Rectangular

| Referencia | Medidas |
|------------|--------------|
| 00383 | 35x24 cm |
| 00382 | 42x31 cm |
| 00381 | 50x36 cm |
| 00384 | 63,5x44,5 cm |
| 00385 | 60x40 cm |
| 00388 | 53x32 cm |
| 03824 | 42x31 cm |
| 03814 | 50x36 cm |
| 00087 | 38x23 cm |
| 00086 | 47x31 cm |



Oval

| Referencia | Medidas |
|------------|------------|
| 00089 | 53x39,5 cm |



Asa

| Referencia | Medidas |
|------------|----------|
| 00082 | 52x31 cm |
| 00081 | 60x36 cm |
| 00084 | 75x44 cm |



Redonda

| Referencia | Medidas |
|------------|---------|
| 00075 | Ø 31 cm |
| 00085 | Ø 35 cm |



Con tapa

| Referencia | Medidas |
|------------|----------|
| 38202 | 42x31 cm |



Classic
Acero inoxidable 18/10
GN 1/1 Apilable

| Referencia | Medidas |
|------------|----------|
| 11295 | 53x32 cm |



GN 1/1 Apilable 45 agujeros Ø 3,5 cm

| Referencia | Medidas |
|------------|----------|
| 11168 | 53x32 cm |



Swing
Acero inoxidable 18/10
GN 1/1 Apilable

| Referencia | Medidas |
|------------|----------|
| 01425 | 53x32 cm |



| Referencia | Medidas |
|------------|------------|
| 01415 | 28,5x20 cm |
| 01420 | 53x32,5 cm |



| Referencia | Medidas |
|------------|--------------|
| 01416 | 32,5x32,5 cm |



Elevadas
Acero inoxidable 18/10

| Referencia | Medidas |
|------------|----------|
| 11470 | Ø 48 cm |
| 11475 | 53x32 cm |



Halbmond
Acero inoxidable 18/10
GN 1/1

| Referencia | Medidas |
|------------|----------|
| 11111 | 53x32 cm |



Classic
Acero inoxidable 18/10

| Referencia | Medidas |
|--------------|----------|
| GN 1/1 00395 | 53x32 cm |
| 00399 | 41x31 cm |



| | |
|--------------|--------------|
| GN 2/3 00389 | 35,4x32,5 cm |
| 00396 | Ø 35 cm |
| 00398 | 46x34 cm |





Frutero Royal

| Referencia | Medidas |
|------------|---------|
|------------|---------|

24336 Ø 24/33/42x43,5 cm



Buffet Ladder

Bol vidrio Ø 23 cm

| Referencia | Medidas |
|------------|---------|
|------------|---------|

11599 39x31x66 cm



Buffet Stand

| Referencia | Medidas |
|------------|---------|
|------------|---------|

33235 Ø 27x32 cm
33240 Ø 32x53 cm

Fruteros



Frutero inox 18/10

| Referencia | Medidas |
|------------|---------|
|------------|---------|

30270 Ø 21x20,5 cm



Dispensador cubiertos

Acero inoxidable

| Referencia | Medidas | Huecos |
|------------|---------|--------|
|------------|---------|--------|

11996 26x30x20 cm 4
11997 37,5x30x20 cm 6



Dispensador cubiertos

Melamina/SAN

| Referencia | Medidas | Huecos |
|------------|---------|--------|
|------------|---------|--------|

93321 27x27x15 cm 4

Cesto cubiertos GN 1/1

| Referencia | Medidas |
|------------|---------|
|------------|---------|

11966 53x32,5x9 cm



Cesto cubiertos

Polipropileno

| Referencia | Medidas |
|------------|---------|
|------------|---------|

40130 Ø 12x15 cm
40007 Ø 12x15 cm
40131 27x10x15x15 cm
40009 27x10x15x15 cm



Cesto cubiertos

Polipropileno

| Referencia | Medidas |
|------------|---------|
|------------|---------|

40179 26x18x15 cm
40182 26x18x15 cm



Set mesa cubiertos

Melamina/metal

| Referencia | Medidas |
|------------|---------|
|------------|---------|

11927 22x22x26 cm



Country Style

Madera

| Referencia | Medidas |
|------------|---------|
|------------|---------|

11931 Ø 11,5x14 cm

BUFFET
Y CATERING



Estación pan

Melamina/madera

| Referencia | Medidas |
|------------|---------|
|------------|---------|

83615 Bandeja 59,5x35,5x3,5 cm
00953 Tabla 52x34x2 cm
00959 Caja 34x26x12,5 cm
00954 Caja 34x26x20 cm

Cubierta higiénica antialiento

Metal/acrílico

| Referencia | Medidas |
|------------|---------|
|------------|---------|

11556 82x42x45 cm



Tablas pan madera antideslizante

| Referencia | Referencia | Medidas |
|------------|------------|---------|
|------------|------------|---------|

PINO ACACIA
00955 00883 47,5x32x2 cm
00956 00884 53x32x2 cm
00957 00885 60x40x2 cm

Tablas de pan

Paneras buffet



Dispensador pan
Cestas no incluidas. Ruedas traseras

| Referencia | Medidas |
|------------|----------------|
| P906.100 | 35,5x50x160 cm |
| P906.150 | 35,5x50x160 cm |

Cesta redonda inclinada

| Referencia | Referencia | Medidas |
|------------|------------|---------------|
| | | |
| P100.750 | P100.752 | Ø 36x10/20 cm |
| P100.751 | P100.753 | Ø 40x13/23 cm |

Polipropileno

Trenzado a mano en fibra sintética, su acabado mate da aspecto de un producto natural.

Cestas baguette

| Referencia | Medidas |
|------------|------------|
| P100.780 | Ø 35x35 cm |
| P100.781 | Ø 36x36 cm |



Profi Line

| Referencia | Medidas |
|------------|---------|
| 50210 | Ø 37 cm |
| 50215 | Ø 42 cm |



| Referencia | Medidas |
|------------|------------|
| 50205 | Ø 31/37 cm |

| Referencia | Medidas |
|------------|-----------|
| 50100 | Ø 36,5 cm |
| 50105 | Ø 42 cm |
| 50110 | Ø 46 cm |



Polipropileno

| Referencia | Medidas |
|------------|-------------|
| 50510 | 60x40x60 cm |



Polipropileno

| Referencia | Medidas |
|------------|---------------|
| 50500 | Ø 28/30x38 cm |
| 50501 | Ø 28/30x38 cm |

Polipropileno

| Referencia | Medidas |
|------------|------------|
| 50900 | 40x20x5 cm |
| 50905 | 40x30x5 cm |
| 50910 | 60x20x5 cm |
| 50915 | 60x40x5 cm |



Metal

| Referencia | Medidas |
|------------|----------------|
| 33221 | 46x24x18/21 cm |



Polipropileno

| Referencia | Medidas |
|------------|----------------|
| 50300 | 30x40x27/16 cm |
| 50305 | 45x40x27/16 cm |
| 50310 | 60x40x27/16 cm |



| Referencia | Referencia | Referencia | Medidas | GN |
|------------|------------|------------|----------------|-----|
| | | | | |
| 40291 | 40220 | 40260 | 53x32x6 cm | 1/1 |
| 40290 | 40222 | 40262 | 32,5x26,5x6 cm | 1/2 |
| 40223 | 40224 | 40263 | 32,5x17,6x6 cm | 1/3 |
| 40225 | 40226 | 40264 | 26,5x16,2x6 cm | 1/4 |
| 40227 | 40228 | 40266 | 17,6x16,2x6 cm | 1/6 |
| 40229 | 40230 | 40268 | 32,5x35,4x6 cm | 2/3 |

| Referencia | Referencia | Referencia | Medidas | GN |
|------------|------------|------------|-----------------|-----|
| | | | | |
| 40293 | 40240 | 40270 | 53x32x10 cm | 1/1 |
| 40292 | 40242 | 40272 | 32,5x26,5x10 cm | 1/2 |
| 40243 | 40244 | 40274 | 32,5x17,6x10 cm | 1/3 |
| 40245 | 40246 | 40276 | 26,5x16,2x10 cm | 1/4 |
| 40247 | 40248 | 40278 | 17,6x16,2x10 cm | 1/6 |
| 40249 | 40250 | 40280 | 32,5x35,4x10 cm | 2/3 |



| Referencia | Medidas | GN |
|------------|---------------|-----|
| 11553 | 29x27x35 cm | 1/2 |
| 11555 | 50x34x37,5 cm | 1/1 |





Metacrilato



| Referencia | Medidas |
|------------|---------|
|------------|---------|

| | |
|-------|-------------|
| 11566 | 26x10x11 cm |
| 11563 | 22x17x9 cm |



Madera



| Referencia | Medidas |
|------------|---------|
|------------|---------|

| | |
|-------|--|
| 11575 | 33,5x20x9 cm  |
| 11574 | 33,5x20x9 cm  |



Madera

| Referencia | Medidas |
|------------|---------|
|------------|---------|



| | |
|-------|--|
| 11775 | 31x28x9 cm  |
| 11776 | 31x28x9 cm  |

Dispensador de Miel y mermelada para buffet



Polipropileno



| Referencia | Medidas |
|------------|---------|
|------------|---------|

| | |
|-------|--|
| 40299 | Ø 26x17 cm  |
| 30299 | Ø 26x17 cm  |



Algodón

| Referencia | Medidas |
|------------|---------|
|------------|---------|

| | |
|-------|--|
| 30380 | Ø 20x23,5 cm  |
| 30390 | Ø 20x23,5 cm  |

Huevera
Melamina



| Referencia | Medidas |
|------------|---------|
|------------|---------|

| | |
|----------|------------|
| B885190R | Ø 5x6,5 cm |
|----------|------------|



Madera



| Referencia | Medidas |
|------------|---------|
|------------|---------|

| | |
|-------|---|
| 11635 | 17x17x10 cm  |
| 11636 | 17x17x10 cm  |
| 11637 | 17x17x10 cm  |



Madera

| Referencia | Medidas |
|------------|---------|
|------------|---------|

| | |
|-------|--|
| 11638 | 27x17x10 cm  |
| 11639 | 27x17x10 cm  |
| 11640 | 27x17x10 cm  |



Portabolsitas azúcar
Melamina

| Referencia | Referencia | Medidas |
|------------|------------|---------|
|------------|------------|---------|

| | | |
|--|---|-------------|
|  |  | 7x11x5,5 cm |
| B885188V | B885191V | |

Utensilios buffet



| Referencia | Pieza |
|------------|-------|
|------------|-------|

| | |
|----------|-------------------|
| 07600080 | Pala Lasaña 28 cm |
|----------|-------------------|



| Referencia | Pieza |
|------------|-------|
|------------|-------|

| | |
|----------|-------------------|
| 07600082 | Pala Huevos 28 cm |
|----------|-------------------|



| Referencia | Pieza |
|------------|-------|
|------------|-------|

| | |
|----------|----------------------------|
| 07600081 | Pala Tarta con corte 30 cm |
|----------|----------------------------|



| Referencia | Pieza |
|------------|-------|
|------------|-------|

| | |
|----------|-----------------------------|
| 07600069 | Pala Servir con corte 28 cm |
|----------|-----------------------------|



| Referencia | Pieza |
|------------|-------|
|------------|-------|

| | |
|----------|----------------------|
| 07600143 | Tenedor 5 púas 26 cm |
|----------|----------------------|



| Referencia | Pieza |
|------------|-------|
|------------|-------|

| | |
|----------|----------------------|
| 07600288 | Tenedor 3 púas 30 cm |
|----------|----------------------|



| Referencia | Pieza |
|------------|-------|
|------------|-------|

| | |
|----------|------------------------|
| 07600060 | Cuchara de Arroz 26 cm |
|----------|------------------------|



| Referencia | Pieza |
|------------|-------|
|------------|-------|

| | |
|----------|-------------------------|
| 07600059 | Cucharón Multiuso 30 cm |
|----------|-------------------------|



| Referencia | Pieza |
|------------|-------|
|------------|-------|

| | |
|----------|--------------------------------|
| 07600259 | Cuchara servir perforada 30 cm |
|----------|--------------------------------|

Pinzas profesionales



| Referencia | Pieza |
|------------|-------|
|------------|-------|

| | |
|----------|-----------------|
| 50919601 | Spaghetti 26 cm |
|----------|-----------------|



| Referencia | Pieza |
|------------|-------|
|------------|-------|

| | |
|----------|-------------------------|
| 50919901 | Pinzas Gastronorm 26 cm |
|----------|-------------------------|



| Referencia | Pieza |
|------------|-------|
|------------|-------|

| | |
|----------|--------------|
| 50919701 | Servir 26 cm |
|----------|--------------|



| Referencia | Pieza |
|------------|-------|
|------------|-------|

| | |
|----------|-----------|
| 50919501 | Pan 26 cm |
|----------|-----------|



| Referencia | Pieza |
|------------|-------|
|------------|-------|

| | |
|----------|----------------|
| 50919001 | Ensalada 26 cm |
|----------|----------------|



| Referencia | Pieza |
|------------|-------|
|------------|-------|

| | |
|----------|--------------------|
| 50919400 | Pinzas Dulce 20 cm |
|----------|--------------------|

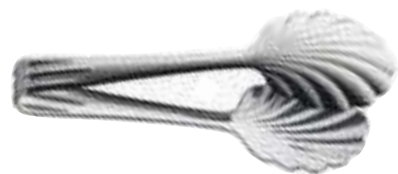

| Referencia | Pieza |
|------------|-------|
|------------|-------|

| | |
|----------|------------------|
| 50919500 | Pinzas Pan 22 cm |
|----------|------------------|



| Referencia | Pieza |
|------------|-------|
|------------|-------|

| | |
|--------|-------------------------|
| 605100 | Pinza Charcutería 10 cm |
|--------|-------------------------|



| Referencia | Pieza |
|------------|-------|
|------------|-------|

| | |
|-----------|-------------------------|
| 509180000 | Pinzas repostería 20 cm |
|-----------|-------------------------|



Inox 18/10

| Referencia | Medida |
|------------|--------|
|------------|--------|

| | |
|-------|-------------|
| 00685 | Largo 25 cm |
|-------|-------------|



Inox 18/10

| Referencia | Medida |
|------------|--------|
|------------|--------|

| | |
|-------|-------------|
| 00688 | Largo 25 cm |
|-------|-------------|



Inox 18/10

| Referencia | Medida |
|------------|--------|
|------------|--------|

| | |
|-------|-------------|
| 00686 | Largo 25 cm |
|-------|-------------|



Inox 18/10

| Referencia | Medida |
|------------|--------|
|------------|--------|

| | |
|-------|-------------|
| 00687 | Largo 25 cm |
|-------|-------------|



| Referencia | Pieza |
|------------|-------|
|------------|-------|

| | |
|----------|--------------------|
| 50919100 | Pinza Azúcar 11 cm |
|----------|--------------------|



Policarbonato (PP)

Referencia **Medidas**

| | | |
|----------|-------|-------------------------------------|
| B885270R | 29 cm | <input type="checkbox"/> |
| B885272R | 29 cm | <input checked="" type="checkbox"/> |



Policarbonato (PP)

Referencia **Medidas**

| | | |
|----------|---------|-------------------------------------|
| B885271R | 22,5 cm | <input type="checkbox"/> |
| B885273R | 22,5 cm | <input checked="" type="checkbox"/> |



Policarbonato (PP)

Referencia **Medidas**

| | | |
|----------|-------|-------------------------------------|
| B885274R | 33 cm | <input type="checkbox"/> |
| B885275R | 33 cm | <input checked="" type="checkbox"/> |
| B885276R | 36 cm | <input type="checkbox"/> |
| B885277R | 36 cm | <input checked="" type="checkbox"/> |



Policarbonato (PP)

Referencia **Medidas**

| | | |
|----------|-------|-------------------------------------|
| B885278R | 25 cm | <input type="checkbox"/> |
| B885279R | 25 cm | <input checked="" type="checkbox"/> |



Reposacucharas melamina

Referencia **Medidas**

| | |
|-------|--------------|
| 83897 | 26x13x4,5 cm |
|-------|--------------|



Reposacucharas melamina

Referencia **Medidas**

| | |
|-------|------------|
| 83801 | 16x10x5 cm |
|-------|------------|



Reposacucharas inox

Referencia **Medidas**

| | |
|-------|--------------|
| 00650 | 27x11x3,5 cm |
|-------|--------------|



Melamina
Capacidad 1 L

Referencia

| | |
|-------|-------------------------------------|
| 83867 | <input type="checkbox"/> |
| 83868 | <input checked="" type="checkbox"/> |



Set 10 clips FLEX LABEL
Policarbonato PC

Referencia **Referencia** **Medidas**

| | | |
|-------------------------------------|--------------------------|---------|
| <input checked="" type="checkbox"/> | <input type="checkbox"/> | |
| 71474 | 71472 | 9,5 cm |
| 71475 | 71473 | 12,5 cm |



Set 10 clips portaetiquetas
Polipropileno

Referencia **Referencia** **Medidas**

| | | |
|-------------------------------------|--------------------------|----------|
| <input checked="" type="checkbox"/> | <input type="checkbox"/> | |
| 71482 | 71483 | 6x2,7 cm |



Soporte cartelito FLEXILABEL
Metal cromado. Incluye 10 cartelitos

Referencia **Medidas**

| | |
|-------|-------|
| 71480 | 12 cm |
| 71481 | 23 cm |



Pizarra

Referencia **Medidas**

| | |
|-------|-----------|
| 00060 | 12x4x7 cm |
|-------|-----------|



Set 4
Acrílico

Referencia **Medidas**

| | | |
|----------|-------|----------|
| Cubo | 00078 | 3x3x4 cm |
| Cilindro | 00079 | 3x3x4 cm |



Set 4

Referencia **Medidas**

| | | |
|----------|-------|---------------|
| Acrílico | 00074 | 3x3x12 cm |
| Madera | 00700 | 2,5x2,5x12 cm |

Vajilla Catering Wave



Cuchara degustación



Cucharilla



Vaso degustación



| Referencia | Referencia | Referencia | Descripción | Dimensiones (mm) | Embalaje |
|------------|------------|--------------|---------------------|--------------------|----------|
| BLANCO | NEGRO | TRANSPARENTE | | | |
| 01769 | 41769 | 91769 | Cuchara degustación | 121x42x20 | 50 |
| 01770 | 41770 | 91770 | Cucharilla | 90x22x4 | 100 |
| 01760 | 41760 | 91760 | Vaso degustación | 51x51x33 / 5 cl | 12 |
| 01761 | 41761 | 91761 | Vaso degustación | 51x51x55 / 9 cl | 12 |
| 01771 | 41771 | 91771 | Brocheta | 82x3x3 | 250 |
| 01772 | 41772 | 91772 | Brocheta | 200x3x3 | 250 |
| 01764 | 41764 | 91764 | Plato llano | 127x127x15 | 20 |
| 01762 | 41762 | 91762 | Plato llano pequeño | 80x80x15 | 25 |
| 01765 | 41765 | 91765 | Plato hondo | 127x127x15 / 25 cl | 20 |
| 01763 | 41763 | 91763 | Plato hondo pequeño | 70x70x23 / 7 cl | 25 |
| 01768 | 41768 | 91768 | Bandeja individual | 200x70x8 | 20 |
| 01766 | 41766 | 91766 | Bandeja cuadrada | 280x280x15 | 12 |
| 01767 | 41767 | 91767 | Bandeja rectangular | 480x240x17 | 6 |



Brocheta



Plato llano



Plato hondo



Bandeja individual



Bandeja Cuadrada



Bandeja Rectangular

Vajilla Catering Nature

| Referencia | Referencia | Referencia | Descripción | Dimensiones (mm) | Embalaje |
|------------|------------|--------------|---------------------|------------------|----------|
| BLANCO | NEGRO | TRANSPARENTE | | | |
| 01734 | 41734 | 91734 | Cuchara degustación | 119x40x20 | 100 |
| 01739 | 41739 | 91739 | Cucharilla | 98x20x11 | 250 |
| 01735 | 41735 | 91735 | Vaso degustación | 56x43 / 5 cl | 50 |
| 01736 | 41736 | 91736 | Vaso degustación | 60x64 / 9 cl | 50 |
| 01746 | 41746 | 91746 | Vaso degustación | 82x60 / 25 cl | 50 |
| 01740 | 41740 | 91740 | Pincho | 88x15x6 | 250 |
| 01741 | 41741 | 91741 | Brocheta | 196x15x6 | 250 |
| 01744 | 41744 | 91744 | Plato llano | 97x79x15 | 50 |
| 01745 | 41745 | 91745 | Plato hondo | 90x84x32 | 50 |
| 01743 | 41743 | 91743 | Plato individual | 160x104x18 | 20 |
| 01742 | 41742 | 91742 | Bandeja degustación | 340x209x19 | 12 |



Cuchara degustación



Cucharilla



Pincho



Brocheta



Vaso degustación



Plato llano



Plato hondo



Plato individual



Bandeja degustación



Servicio cóctel desechable

Platillo flat

V8846018-19 - Negro
V8846018-11 - Blanco
8x6,6 cm / 10 ml
Embalaje: 50 ud



Cuchara estándar

V8842717C - Transparente
V8842717C-19 - Negro
V8842717C-11 - Blanco
12 cm / 15 ml
Embalaje: 30 ud



Mini copa cuadrada

V8846006-21 - Transparente
V8846006-19 - Negro
V8846006-11 - Blanco
7x7 cm / 90 ml
Embalaje: 25 ud



Cuchara fish

V8842718C - Transparente
V8842718C-19 - Negro
V8842718V-11 - Blanco
12 cm / 20 ml
Embalaje: 30 ud



Vaso cónico alto

V8846005-21 - Transparente
V8846005-19 - Negro
V8846005-11 - Blanco
5 cm Ø / 75 ml
Embalaje: 25 ud



Mini cuchara

V8842716C - Transparente
V8842716C-19 - Negro
V8842716C-11 - Blanco
100 mm
Embalaje: 50 ud



Vaso cónico maxi

V8846023-21 - Transparente
V8846023-19 - Negro
V8846023-11 - Blanco
5,5 cm Ø / 100 ml
Embalaje: 10 ud



Mini tenedor

V8842715C - Transparente
V8842715C-19 - Negro
V8842715C-11 - Blanco
100 mm
Embalaje: 50 ud



Brocheta bambú lazo

001010204 - Largo 90 mm
001010205 - Largo 150 mm
Embalaje: 200 ud



Brocheta rojo/negro

001010135 - Largo 120 mm
Embalaje: 200 ud



Brocheta bambú golf

001010127 - Largo 105 mm
001010128 - Largo 150 mm
Embalaje: 200 ud



Brocheta bola color

001010130 - Largo 120 mm
001010129 - Largo 120 mm
Embalaje: 200 ud



Bol rombo

V8846001-21 - Transparente
V8846001-19 - Negro
V8846001-11 - Blanco
5,5x5,6 cm / 95 ml
Embalaje: 25 ud



Chupito zero

V8846025-21 - Transparente
V8846025-19 - Negro
V8846025-11 - Blanco
5,3 cm Ø / 60 ml
Embalaje: 15 ud



Bandeja pequeña

V8846010-21 - Transparente
V8846010-19 - Negro
V8846010-11 - Blanco
6,5x6,5 cm / 45 ml
Embalaje: 25 ud



Bol cubo

V8846027-21 - Transparente
V8846027-19 - Negro
V8846027-11 - Blanco
4,7x4,7 cm / 60 ml
Embalaje: 15 ud



Bandeja mediana

V8846011-21 - Transparente
V8846011-19 - Negro
V8846011-11 - Blanco
13x13 cm / 130 ml
Embalaje: 12 ud



Bol rectangular

V8846028-21 - Transparente
V8846028-19 - Negro
V8846028-11 - Blanco
5,8x4,5 cm / 60 ml
Embalaje: 15 ud



Bol pequeño

V8846012-21 - Transparente
V8846012-19 - Negro
V8846012-11 - Blanco
8,3 cm Ø / 150 ml
Embalaje: 12 ud



Bol pagoda mediano

V8846100-21 - Transparente
V8846100-19 - Negro
V8846100-11 - Blanco
8x8 cm / 200 ml
Embalaje: 12 ud



Bol mini

V8846026-21 - Transparente
V8846026-19 - Negro
V8846026-11 - Blanco
6,7 cm Ø / 60 ml
Embalaje: 10 ud



Bol pagoda pequeño

V8846104-21 - Transparente
V8846104-19 - Negro
V8846104-11 - Blanco
7x7 cm / 150 ml
Embalaje: 12 ud



Bol mediano

V8846013-21 - Transparente
V8846013-19 - Negro
V8846013-11 - Blanco
11 cm Ø / 220 ml
Embalaje: 6 ud



Bol pagoda pequeño

V8846021-21 - Transparente
V8846021-19 - Negro
V8846021-11 - Blanco
6,7x6,7 cm / 120 ml
Embalaje: 25 ud



Policarbonato colectividades



B-1



B-2



| Referencia | Descripción | Medidas |
|------------|------------------------|----------|
| 66930 | Bandeja isotérmica B-1 | 55x38 cm |
| 66943 | Bandeja isotérmica B-2 | 38x28 cm |



| Referencia | Descripción | Medidas |
|------------|--------------------|-----------------|
| 66933 | Plato llano c/tapa | 22 cm Ø |
| 66934 | Plato hondo c/tapa | 19 cm Ø - 45 cl |



| Referencia | Descripción | Medidas |
|------------|------------------------|---------------------------|
| 66937 | Bol c/tapa | 13 cm Ø x h6,5 cm - 45 cl |
| 66948 | Bol c/tapa doble pared | 12,5 cm Ø x h7cm - 50 cl |



| Referencia | Descripción | Medidas |
|------------|---------------------------|--------------|
| 66931 | Carro portabandejas 20 ud | 90x62x148 cm |



| Referencia | Descripción | Medidas |
|------------|---------------------------|----------------------------|
| 66936 | Taza desayuno | 9 cm Ø x h7 cm - 30 cl |
| 66949 | Taza desayuno doble pared | 8,5 cm Ø x h7,5 cm - 25 cl |

MAQUINARIA

Machinery • Machinerie • Macchine • Maschinen



Trituradores



sammic

Trituradores profesionales Sammic

- Potencias de 250 a 750 W.
- Brazos trituradores de 200 a 600 mm y brazos batidores.
- Brazo triturador: para preparar purés (verduras, patatas, potajes, etc.), cremas (cebolla, pimientos, tomate, pastelera, etc.) y todo tipo de salsas.
- Brazo batidor: para montar nata, preparar merengues, chantilly, salsa mahonesa y genovesa, tortillas, crepes, soufflés, etc.
- TR/BM-350: variador de velocidad con sistema inteligente de control de revoluciones, consiguiendo la máxima potencia del motor en todo momento.
- Fabricados en materiales muy resistentes y de primera calidad.
- Brazos fabricados totalmente en inoxidable.
- Diseño ergonómico.
- Funcionamiento sencillo y facilidad de limpieza.

| | TR-200 | TR-250 | TR-350 | | TR-550 | | TR-750 | TR/BM-250 | | | TR/BM-350 | |
|--|----------------------|--------|--------|-------|--------|-------|--------|----------------|----------------|-------------------------|----------------|-------------------------|
| | | | BN | BL | BL | BXL | | BXS | BS | BB-250 | BN | BB-350 |
| GUIA DE SELECCIÓN RECIPIENTES HASTA (LITROS) | 10 | 15 | 60 | 70 | 100 | 150 | 200 | 10 | 15 | 2-30 Claras huevo | 60 | 2-50 Claras huevo |
| CARACTERÍSTICAS ALIMENT. ELÉCTRICA | 230V / 50-60 Hz / 1~ | | | | | | | | | | | |
| POTENCIA (W) | 250 | 250 | 350 | 350 | 550 | 550 | 750 | 250 | 250 | 250 | 350 | 350 |
| VELOCIDAD (R.P.M.) FIJA (EN LÍQUIDO) | 9.000 | 9.000 | 9.000 | 9.000 | 9.000 | 9.000 | 9.000 | | | | | |
| VARIABLE (EN LÍQUIDO) | - | - | - | - | - | - | - | 1500- 9.000 | 1500- 9.000 | 130- 1.500 | 1500- 9.000 | 130- 1.500 |
| DIMENSIONES (MM) | | | | | | | | | | | | |
| BRAZO TRITURADOR | 200 | 290 | 420 | 500 | 500 | 585 | 600 | 200 | 290 | | 420 | |
| Ø CAZOLETA | 65 | 82 | 94 | 94 | 94 | 105 | 118 | 65 | 82 | | 94 | |
| BRAZO BATIDOR | | | | | | | | | | 300 | | 396 |
| TOTAL | 485 | 550 | 732 | 805 | 805 | 885 | 935 | 460 | 550 | 560 | 732 | 705 |
| PESO NETO (KG) | 1.9 | 1.9 | 3.35 | 3.55 | 3.95 | 4.15 | 4.25 | 1.5 | 1.9 | 2.3 | 3.35 | 3.5 |

Cortadoras hortalizas

Las cortadoras de hortalizas Sammic son máquinas muy robustas que están fabricadas en acero inoxidable con materiales de la más alta calidad, aptos para el contacto con alimentos. La gama comprende distintos tipos de bloques motor y cabezales, que permiten alcanzar una producción de hasta 1.000 Kg/h, adecuándose a las necesidades de cada usuario.

El motor, ventilado, permite un trabajo continuo. El panel de mandos estanco, es electrónico y de uso muy intuitivo.

Las cortadoras de hortalizas CA de Sammic pueden dotarse de una amplia gama de discos y rejillas de 205 mm de diámetro. La tecnología empleada en su fabricación asegura un corte uniforme, requiriéndose un menor esfuerzo para el corte, minimizando el deterioro del alimento y generándose menos líquido. Combinando los discos y rejillas entre sí, se pueden obtener más de 70 tipos de cortes y rallados diferentes. La gama de cortadoras de hortalizas Sammic se ha diseñado teniendo en cuenta factores ergonómicos y los flujos de trabajo más habituales.



Más de 70 tipos de cortes y rallados

| | CA-301 | CA-301 VV | CA-401 | CA-401 VV | CA-601 |
|-------------------------------|---------------------|------------------------|---------------------|---------------------|---------------------|
| | | GUÍA DE SELECCIÓN | | | |
| CUBIERTOS (DESDE / HASTA) | 100-450 | 100-450 | 100-600 | 100-600 | 200-1000 |
| PRODUCCIÓN HORA | 150-450 Kg | 150-500 Kg | 200-650 Kg | 200-650 Kg | 500-1000 Kg |
| | | CARACTERÍSTICAS | | | |
| ÁREA BOCA ENTRADA (CORTADORA) | 136 cm ² | 136 cm ² | 286 cm ² | 286 cm ² | 273 cm ² |
| VELOCIDAD MOTOR | 365 rpm | 365-1000 rpm | 365 rpm | 365-1000 rpm | 365-730 rpm |
| | | POTENCIA | | | |
| MONOFÁSICA | 550W | 1500W | 550W | 1500W | - |
| TRIFÁSICA | 370W | - | 550W | - | 750W |
| | | DIMENSIONES EXTERIORES | | | |
| DIMENSIONES EXTERIORES | 389x405x544 mm | 391x409x567 mm | 389x382x646 mm | 391x400x667 mm | 431x418x767 mm |
| PESO NETO | 21 Kg | 28 Kg | 24 Kg | 30 Kg | 26 Kg |

Cutters-Emulsionadores

Picadoras-mezcladoras con muchas posibilidades. Máquina industrial para cortar, triturar, mezclar, amasar cualquier alimento en segundos: hierbas y verduras, masas diversas, carnes crudas o cocinadas, pescado, surimi, frutas, frutos secos, hielo, etc.

CUTTERS CK:

2 velocidades y 5 u 8 litros de capacidad.

Los cutters CK-5 y CK-8 de Sammic son máquinas muy robustas que están enteramente construidas en materiales alimentarios. El caldero, fácilmente extraíble, está fabricado en acero inoxidable de gran calidad y cuenta con asa ergonómica así como una tapa de policarbonato altamente resistente provisto de un orificio que permite añadir líquidos en funcionamiento.

El panel de mandos, electrónico y estanco, es de uso muy intuitivo y está provisto de un pulsador de ráfagas.

Los cutters Sammic están equipados con un microinterruptor de seguridad que evita la puesta en marcha si el caldero o la tapa no están en la posición adecuada.

Los cutters CK son muy fáciles de limpiar y están homologadas por NSF Internacional.

Opcionalmente pueden dotarse del exclusivo revolvero "cut&mix", que permite obtener un producto más homogéneo a la vez que evita el sobrecalentamiento del mismo.

CUTTERS-EMULSIONADORES CKE:

Velocidad variable, 5 u 8 litros de capacidad y revolvero "cut&mix", incorporado.

La gama CKE difiere de la CK en que está especialmente concebido para trabajar con líquidos y emulsionar. Para ello, cuenta con velocidad variable, el panel de mandos incluye temporizador y la tapa incluye el revolvero "cut&mix".

El resto de características coincide con las de la gama CK.

GAMA COMPACTA: SK/SKE

Gama de cutter SK-3 y cutter-emulsionador SKE-3, con caldero de 3 litros.

Cuentan con un recipiente de acero inoxidable extraíble y tapa con orificio para añadir líquidos en funcionamiento. El panel de mandos es electrónico y cuentan con variador de velocidad con sistema continuo. Los cutters SK/SKE están provistos de microinterruptor de seguridad.



| | CK-5 | CK-8 | CKE-5 | CKE-8 | SK-3 | SKE-3 |
|------------------------------|-------------------|-----------------|----------------|----------------|----------------|----------------|
| | GUÍA DE SELECCIÓN | | | | | |
| CUBIERTOS (DESDE / HASTA) | 20-75 | 20-100 | 20-75 | 20-100 | 10-25 | 10-30 |
| CAPACIDAD MÁXIMA DE PRODUCTO | 3 Kg | 4 Kg | 3 Kg | 4 Kg | 1 Kg | 2 Kg |
| | CARACTERÍSTICAS | | | | | |
| CAPACIDAD DEL CALDERO | 5.5 l | 8 l | 5.5 l | 8 l | 3 l | 3 l |
| DIMENSIONES DEL CALDERO | Ø 240x150 mm | Ø 240x240 mm | Ø 240x150 mm | Ø 240x240 mm | Ø 160x160 mm | Ø 160x160 mm |
| POTENCIA TOTAL | 900-1500 W | 900-1500 W | 1250 W | 1250 W | 500 W | 500 W |
| 2 VELOCIDADES | sí | sí | - | - | - | - |
| VELOCIDAD VARIABLE | - | - | sí | sí | sí | sí |
| VELOCIDAD, MIN-MAX | 1500 / 3000 rpm | 1500 / 3000 rpm | 385 / 3000 rpm | 385 / 3000 rpm | 450 / 3000 rpm | 450 / 3000 rpm |
| DIMENSIONES EXTERIORES | 284x374x439 mm | 284x374x488 mm | 284x374x439 mm | 284x374x488 mm | 240x370x305 mm | 240x370x305 mm |
| PESO NETO | 21.6 Kg | 23 Kg | 23 Kg | 24 Kg | 11 Kg | 11 Kg |

Freidoras FA



FA-6

- Construida totalmente en acero inoxidable AISI 304 (18/10).
- Cuba interior embutida de AISI 304, sin ángulos y con las marcas de MÁX-MÍN del nivel de aceite.
- Cabezal eléctrico extraíble para facilitar su limpieza.
- Termostato de trabajo regulable hasta 200°C / 20 A.
- Termostato de seguridad con rearme manual 230°C.
- Resistencia blindada en acero inoxidable.
- Sistema de fijación de la cesta para escurrir el aceite en el cabezal.
- Cesta reforzada en malla y varilla en acero inoxidable AISI 304 (18/10).
- Patas antideslizantes.
- Modelo FA10: con grifo para evacuar el aceite.



FA-10

| Modelo | Dimensiones LxPxH (mm) | Potencia kw | Voltaje V | Capacidad L | Cesta LxPxH (mm) | Raciones 200 g |
|-----------------|------------------------|-------------|-----------|-------------|------------------|----------------|
| FA4 | 180x425x180 | 2 | 230 | 4 | 120x240x85 | 20 |
| FA6 | 265x425x225 | 3 | 230 | 6 | 210x235x95 | 30 |
| FA6+6 | 530x425x225 | 3+3 | 230 | 6+6 | 210x235x95 | 60 |
| FA8 | 265x425x225 | 4 | 230 | 8 | 210x235x110 | 45 |
| FA8+8 | 530x425x225 | 4+4 | 230 | 8+8 | 210x235x110 | 90 |
| FA10 | 265x425x225 | 4 | 230 | 10 | 210x235x110 | 50 |
| FA10+10 | 530x425x225 | 4+4 | 230 | 10+10 | 210x235x110 | 100 |
| FA10 MAX 230 | 265x425x225 | 6 | 230 | 10 | 210x235x110 | 75 |
| FA10+10 MAX 230 | 530x425x225 | 6+6 | 230 | 10+10 | 210x235x110 | 150 |
| FA10 MAX 400 | 265x425x225 | 6 | 400 | 10 | 210x235x110 | 75 |
| FA10+10 MAX 400 | 530x425x225 | 6+6 | 400 | 10+10 | 210x235x110 | 150 |



Freidoras FAH



FAH-17

- Construida totalmente en acero inoxidable AISI 304 (18/10).
- Cuba interior embutida de AISI 304, sin ángulos y con las marcas de MÁX-MÍN del nivel de aceite.
- Cabezal eléctrico extraíble para facilitar su limpieza.
- Termostato de trabajo regulable hasta 200°C / 20 A.
- Termostato de seguridad con rearme manual 230°C.
- Resistencia blindada en acero inoxidable.
- Con grifo incorporado para evacuar el aceite.
- Sistema de elevación de la resistencia para calentar el volumen de aceite necesario para freír.
- Cesta reforzada en malla y varilla en acero inoxidable AISI 304 (18/10).
- Patas regulables en altura antideslizantes.
- Modelo FAR: de alto rendimiento.

| Modelo | Dimensiones LxPxH (mm) | Potencia kw | Voltaje V | Capacidad L | Cesta LxPxH (mm) | Raciones 200 g |
|--------------|------------------------|-------------|-----------|-------------|------------------|----------------|
| FAH10 230 | 325x525x360 | 6 | 230 | 10 | 185x245x110 | 91 |
| FAH10+10 230 | 650x525x360 | 6+6 | 230 | 10+10 | 185x245x110 | 182 |
| FAH10 400 | 325x525x360 | 6 | 400 | 10 | 185x245x110 | 91 |
| FAH10+10 400 | 650x525x360 | 6+6 | 400 | 10+10 | 185x245x110 | 182 |
| FAH17 230 | 360x560x850 | 6 | 230 | 17 | 205x285x120 | 110 |
| FAH17+17 230 | 724x560x850 | 6+6 | 230 | 17+17 | 205x285x120 | 220 |
| FAH17 400 | 360x560x850 | 7 | 400 | 17 | 205x285x120 | 110 |
| FAH17+17 400 | 724x560x850 | 7+7 | 400 | 17+17 | 205x285x120 | 220 |
| FAH25 | 410x645x850 | 15 | 400 | 25 | 235x325x140 | 260 |
| FAH25+25 | 824x645x850 | 15+15 | 400 | 25+25 | 235x325x140 | 520 |
| FAH35 | 531x645x850 | 15 | 400 | 35 | 350x325x150 | 275 |
| FAH35+35 | 1065x645x850 | 15+15 | 400 | 35+35 | 350x325x150 | 550 |
| FAR17 | 360x560x850 | 17 | 400 | 17 | 205x285x120 | 267 |
| FAR25 | 410x645x850 | 25 | 400 | 25 | 235x325x140 | 434 |



FAH-10

Freidoras FH

Sistema agua-aceite

– El agua ocupa la parte que está en el fondo de la cuba mientras que el aceite, debido a su densidad, está por encima del agua. Gracias a este tipo de sistema, los residuos que se desprenden de la fritura van hacia el fondo de la cuba y al contactar con el agua los absorbe y se depositan en el fondo. Por este motivo podemos freír distintos alimentos sin mezclar los sabores.

– Su limpieza y ahorro de aceite es mayor, ya que cada vez que cambiamos el agua evacuamos los residuos de los alimentos, no es necesario filtrar el aceite.

– Nuestro sistema de resistencia móvil, al poder situar el elemento calefactor a la altura deseada, nos permite una serie de ventajas:

- Ahorro de energía: calentamos sólo el volumen de aceite necesario para cada fritura.
- Mayor rapidez: con menos potencia tenemos una respuesta rápida, ya que calentamos un menor volumen de aceite.
- Mayor duración de aceite: al no calentar todo el volumen, el aceite tiene una mayor duración.

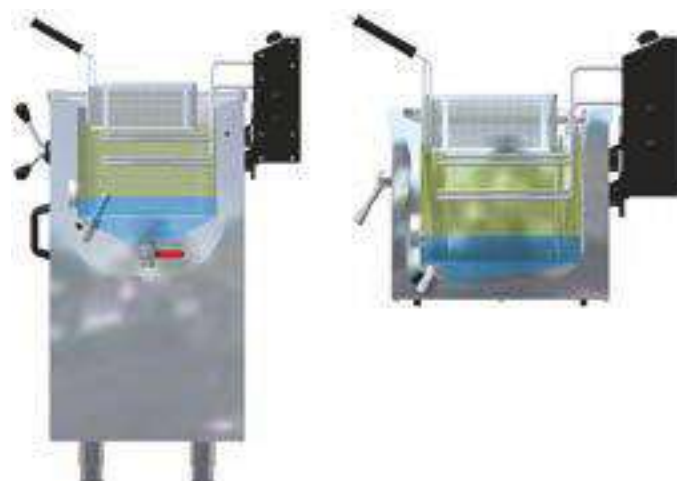

- Construida totalmente en acero inoxidable AISI 304 (18/10).
- Cuba interior embutida de AISI 304, sin ángulos y con las marcas de MÁX-MÍN del nivel de aceite.
- Sistema de agua y aceite: permite el ahorro de aceite y no mezcla sabores.
- Cabezal eléctrico extraíble para facilitar su limpieza.
- Termostato de trabajo regulable hasta 200°C / 20A.
- Termostato de seguridad con rearme manual 230°C.
- Resistencia blindada en acero inoxidable.
- Con grifo incorporado para evacuar el aceite.
- Sistema elevación de la resistencia para calentar el volumen de aceite necesario para freír.
- Cesta reforzada en malla y varilla en acero inoxidable AISI 304 (18/10).
- Patas regulables en altura y antideslizantes.

| Modelo | Dimensiones LxPxH (mm) | Potencia kw | Voltaje V | Capacidad Agua (L) | Capacidad Aceite (L) | Capacidad Total (L) | Cesta LxPxH (mm) | Raciones 200 g |
|-------------|------------------------|-------------|-----------|--------------------|----------------------|---------------------|------------------|----------------|
| F10 | 325x440x360 | 4 | 230 | 3,5 | 10 | 13,5 | 185x245x110 | 55 |
| F10+10 | 650x440x360 | 4+4 | 230 | 3,5+3,5 | 10+10 | 13,5+13,5 | 185x245x110 | 110 |
| FH10 230 | 325x525x360 | 6 | 230 | 3,5 | 10 | 13,5 | 185x245x110 | 91 |
| FH10+10 230 | 650x525x360 | 6+6 | 230 | 3,5+3,5 | 10+10 | 13,5+13,5 | 185x245x110 | 182 |
| FH10 400 | 325x525x360 | 6 | 400 | 3,5 | 10 | 13,5 | 185x245x110 | 91 |
| FH10+10 400 | 650x525x360 | 6+6 | 400 | 3,5+3,5 | 10+10 | 13,5+13,5 | 185x245x110 | 182 |
| FH17 230 | 360x560x850 | 6 | 230 | 4,5 | 15 | 19,5 | 205x285x120 | 110 |
| FH17+17 230 | 724x560x850 | 6+6 | 230 | 4,5+4,5 | 15+15 | 19,5+19,5 | 205x285x120 | 220 |
| FH17 400 | 360x560x850 | 7 | 400 | 4,5 | 15 | 19,5 | 205x285x120 | 110 |
| FH17+17 400 | 724x560x850 | 7+7 | 400 | 4,5+4,5 | 15+15 | 19,5+19,5 | 205x285x120 | 220 |
| FH25 | 410x645x850 | 15 | 400 | 8 | 23 | 31 | 235x325x140 | 260 |
| FH25+25 | 824x645x850 | 15+15 | 400 | 8+8 | 23+23 | 31+31 | 235x325x140 | 520 |
| FH35 | 531x645x850 | 15 | 400 | 14 | 30 | 44 | 350x325x150 | 275 |
| FH35+35 | 1065x645x850 | 15+15 | 400 | 14+14 | 30+30 | 44+44 | 350x325x150 | 550 |

- Hasta 30 kilos de patatas por operación.
- Pueden pelar zanahorias y otros alimentos similares.
- Efectúan pelado por abrasión, que desgasta la superficie del producto por rozamiento.
- Equipados con cuadro de mandos con pulsador de arranque, parada y temporizador de 0 a 6 min.
- Las peladoras se pueden complementar con un soporte y filtro anti-espuma para las peladuras.



Gama aluminio

- Las peladoras de patatas PP-PPC están fabricadas en aluminio altamente resistente y realizan el pelado por abrasión, el cual desgasta la superficie del producto por rozamiento.
- El abrasivo es sumamente resistente y duradero y tanto el plato como el lateral del cilindro están recubiertos por el mismo.
- El cilindro es orientable y todos los modelos cuentan con un cuadro de mandos con pulsador de arranque, parada y temporizador de 0 a 6 minutos.
- Los modelos PPC cuentan con una toma de accesorios en posición fija.



Gama inoxidable

- Modelos de entre 10 y 30 kg de capacidad y sirven para pelar patatas, zanahorias u otros productos similares.
- Construídos en acero inoxidable, revolvedores laterales con abrasivo de carburo de silicio (aprobado por NSF). El plato, de aluminio está recubierto con abrasivo de carburo de silicio (aprobado por NSF) y es fácilmente desmontable para su limpieza.
- Tapa, transparente en policarbonato altamente resistente.
- Puerta de salida, cierre hermético y dispositivo de seguridad.
- Cuadro de mandos con temporizador 0-6 min.
- Auto-arrastre de residuos al desagüe y sistema anti-retorno en la entrada de agua.

| | PP(C)-6+ | PP(C)-12+ | M5 | PI-10 | PI-20 | PI-30 | PES-20 |
|----------------------------------|------------------------|------------------------|----------------|-----------------|-----------------|-----------------|-----------------|
| GUÍA DE SELECCIÓN | | | | | | | |
| CUBIERTOS (DESDE / HASTA) | 30-150 | 60-200 | 10-80 | 60-200 | 100-300 | >200 | 100-300 |
| CARACTERÍSTICAS | | | | | | | |
| CAPACIDAD DE CARGA POR CICLO | 6 Kg | 12 Kg | 5 Kg | 10 Kg | 20 Kg | 30 Kg | 20 Kg |
| PRODUCCIÓN HORA (MAX) | 150 Kg | 270 Kg | 100 Kg | 240 Kg | 480 Kg | 720 Kg | 300 Kg |
| POTENCIA | | | | | | | |
| MONOFÁSICA | 400(PP)W 550 (PPC)W | 400(PP)W 550 (PPC)W | 300W | 550W | 550W | 730W | 550W |
| TRIFÁSICA | 370(PP)W 550(PPC)W | 370(PP)W 550(PPC)W | - | 370W | 550W | 730W | 550W |
| DIMENSIONES EXTERIORES | | | | | | | |
| DIMENSIONES EXTERIORES | 395x700x433 mm | 395x700x503 mm | 333x367x490 mm | 433x635x625 mm | 433x635x735 mm | 622x760x950 mm | 433x635x735 mm |
| DIMENSIONES EXTERNAS CON SOPORTE | 411x700x945 mm | 411x700x1015 mm | 425x555x965 mm | 433x638x1040 mm | 433x638x1155 mm | 546x760x1255 mm | 433x638x1155 mm |

Cortadoras fiambre

Transmisión correa

- Construido totalmente en aluminio anodizado.
- Motor ventilado con transmisión mediante una correa.
- Dispositivo de seguridad incorporado.
- Afilador de cuchilla extraíble para facilitar su limpieza.
- Cuchilla de acero inoxidable AISI 304 (18/10).
- Protector de Plexiglass en el carro incorporado.
- Soporte del carro que se desliza por cojinetes y rodamientos de bolas.
- Cuchilla protegida por la parte interior y perimetral.
- Patas antideslizantes.



| Modelo | Dimensiones LxPxH (mm) | Potencia W | Voltaje V | Ø Cuchilla | Longitud corte LxPxH (mm) | Altura corte | Espesor corte (mm) |
|--------|------------------------|------------|-----------|------------|---------------------------|--------------|--------------------|
| C220S | 445x363x342 | 140 | 230 | Ø220 | 134 | 130 | 0 - 12 |
| C250S | 490x380x360 | 170 | 230 | Ø250 | 185 | 140 | 0 - 12 |
| C275S | 505x410x375 | 280 | 230 | Ø275 | 192 | 146 | 0 - 15 |
| C300S | 570x480x420 | 320 | 230 | Ø300 | 202 | 160 | 0 - 15 |

Transmisión engranajes

- Fabricadas con aluminio pulido y protegidas de la oxidación anódica.
- Cuchilla cóncava de cromo duro.
- Afilador de precisión.
- Deslizamiento del carro mediante rodamientos.
- Seguridad: Anillo, bloqueo de carro y extractor de cuchilla.
- Motor ventilado de gran potencia.
- Los componentes en contacto con los alimentos totalmente desmontables para facilitar su limpieza.

| | GC-220 | GC-250 | GC-275 | GC-300 |
|------------------------|------------|------------|------------|------------|
| DIÁMETRO DE CUCHILLA | 220 mm | 250 mm | 275 mm | 300 mm |
| CAPACIDAD CORTE | 150x200 mm | 190x250 mm | 210x250 mm | 220x260 mm |
| ESPESOR CORTE | 0-10 mm | 0-15 mm | 0-15 mm | 0-15 mm |
| RECORRIDO DEL CARRO | 205 mm | 260 mm | 260 mm | 270 mm |
| POTENCIA TOTAL | 250W | 300W | 300W | 300W |
| DIMENSIONES EXTERIORES | | | | |
| ANCHO | 470 mm | 580 mm | 580 mm | 600 mm |
| FONDO | 380 mm | 470 mm | 470 mm | 480 mm |
| ALTO | 340 mm | 370 mm | 380 mm | 420 mm |



Cortadora CCE - Especial para carne. Cuchilla vertical.

Picadoras carne



- Picadoras de carne profesionales, son ideales para hostelería, colectividades y alimentación.
- Producciones desde 100 hasta 425 Kg/h, según modelo.
- Los modelos PS-12/22/32 cuentan con carrocería y tolvas construidas en acero inoxidable.
- Los motores son ventilados y de gran solidez.
- En el modelo compacto PS-12, el grupo picador está incluido y es de aluminio.
- En los modelos PS-22/32, el grupo picador puede ser de aluminio o acero inoxidable.
- El grupo motor y el grupo picador se piden por separado.
- Todos los modelos se suministran con 1 cuchilla y 1 placa.



| | PS-12 | PS-22 | PS-32 | PS-22R | PS-32R |
|------------------------|----------------|------------------------|----------------|----------------|----------------|
| | | GUÍA DE SELECCIÓN | | | |
| PRODUCCIÓN/HORA (MAX) | 100 Kg | 280 Kg | 425 Kg | 250 Kg | 450 Kg |
| | | CARACTERÍSTICAS | | | |
| DIÁMETRO DE PLACA | 70 mm | 82 mm | 98 mm | 82 mm | 98 mm |
| POTENCIA TOTAL | 440W | 740-1100W | 1500W | 1100W | 2200W |
| | | DIMENSIONES EXTERIORES | | | |
| DIMENSIONES EXTERIORES | 227x470x410 mm | 310x440x480 mm | 310x460x480 mm | 310x438x508 mm | 325x544x553 mm |
| PESO NETO | 18 Kg | 31 Kg | 33 Kg | 40 Kg | 74 Kg |



| | ECM | ECP |
|--------------------------|----------------|----------------|
| PRODUCCIÓN NARANJAS/HORA | 200 | 200 |
| POTENCIA TOTAL | 130W | 130W |
| PRESIÓN POR PALANCA | - | sí |
| PRESIÓN MANUAL | sí | - |
| DIMENSIONES EXTERIORES | 200x280x340 mm | 200x300x370 mm |
| PESO NETO | 8.5 Kg | 10 Kg |

Exprimidores



| Referencia | Tensión | Potencia | Velocidad | Dimensiones |
|------------|-----------|----------|--------------|-------------|
| 69286 | 220-240 V | 180 W | 1.350 r.p.m. | 31x22x35 cm |
| 69283 | 220-240 V | 230 W | 980 r.p.m. | 28x20x40 cm |

Tostadores



| Referencia | Producción de tostadas (máx) | Ancho de cinta | Potencia Total | Dimensiones Exteriores | Peso Neto |
|------------|------------------------------|----------------|----------------|------------------------|-----------|
| TP-10 | 120 | — | 2000 W | 500x280x295 mm | 8,5 kg |
| TP-20 | 240 | — | 2800 W | 500x280x390 mm | 11 kg |
| ST-252 | 500 | 270 mm | 2100 W | 340x410x360-410 mm | 16,5 kg |
| ST-352 | 750 | 370 mm | 2800 W | 460x410x360-410 mm | 19,5 kg |

Termos leche

- Construido totalmente en acero inoxidable 18/10.
- Diseñado para ocupar poco espacio.
- Ideales para leche, caldo, agua, té, café, etc.
- Resistencia blindadas de acero inoxidable.
- Depósito desmontable mediante rosca.
- Regulación automática de temperatura.
- Grifo de evacuación regulable de dos posiciones.
- Patas antideslizantes.



| Modelo | Dimensiones LxPxH (mm) | Potencia W | Consumo W | Voltaje V | Capacidad L |
|--------|------------------------|------------|-----------|-----------|-------------|
| TM3 | 232x232x130 | 1 | 789 | 230 | 3 |
| TM6 | 265x265x525 | 1,5 | 1181 | 230 | 6 |
| TM12 | 525x265x525 | 3 | 2368 | 230 | 6+6 |
| TM20 | 380x380x600 | 3 | 2368 | 230 | 20 |



| Referencia | Dimensiones | Capacidad | Potencia |
|------------|----------------|-----------|----------|
| HM910 | 483x400x281 mm | 24 L | 900 W |
| HM1001 | 520x444x312 mm | 25 L | 1000 W |



| Referencia | Dimensiones | Capacidad | Potencia |
|----------------|----------------|-----------|----------|
| CM1519 Manual | 559x464x372 mm | 26 L | 1500 W |
| CM1529 Digital | 559x464x372 mm | 26 L | 1500 W |
| CM1919 Manual | 559x464x372 mm | 26 L | 1850 W |
| CM1929 Digital | 559x464x372 mm | 26 L | 1850 W |



| Referencia | Dimensiones | Capacidad | Potencia |
|------------|----------------|-----------|----------|
| 69325 | 510x430x315 mm | 25 L | 1000 W |



Batidoras Vaso



TBB145E
1490W-24500RPM
Vaso 1,4 Lt
Controles mecánicos
50-75 servicios/día

TBB160E
1490W-24500RPM
Vaso 1,4 Lt
Controles electrónicos
50-75 servicios/día

TBB175E
1490W-24500RPM
Vaso 1,4 Lt
Controles electrónicos
Control velocidad variable
50-75 servicios/día



MX1000XTXEE/MX1000XTPEE
2600W-30000RPM
Vaso 1,4 Lt / 2,0 Lt
Controles mecánicos
+75 servicios/día



MX1100XTXSEE/MX1100XTPSEE
2600W-45000RPM
Vaso 1,4 Lt / 2,0 Lt
Controles electrónicos
+75 servicios/día



MX1500XTXSEE/MX1500XTPSEE
2600W-45000RPM
Vaso 1,4 Lt / 2,0 Lt
Controles electrónicos programables
+75 servicios/día



MX1200XTXEE
2600W-20000RPM
Vaso 1,4 Lt / 2,0 Lt
Controles electrónicos
Control velocidad variable
+75 servicios/día



Campana Antiruidos
SE500 - Para 1,4 Lt
SE1000 - Para 2,0 Lt

Opcional





- Acabado exterior en aluminio anodizado negro.
- Elegante cristal curvo con templado y abatible.
- Cuba interior embutida de AISI 304, sin ángulos.
- Ajuste de temperatura por termostato digital regulable.
- Puertas correderas alta resistencia.
- Compresor hermético con condensador ventilado tropicalizado.
- Sistema de iluminación por tira de LED.



Onix

| Dimensiones (mm) | Potencia (W) | Temperatura (°C) |
|------------------|--------------|------------------|
| 1146x390x224 | 160 | +2/+6 |
| 1487x390x224 | 160 | +2/+6 |
| 1826x390x224 | 160 | +2/+6 |



Onix 2 pisos

| Bandejas | Dimensiones (mm) | Potencia (W) | Temperatura (°C) |
|----------|------------------|--------------|------------------|
| 6 | 1487x390x330 | 160 | +2/+6 |
| 8 | 1826x390x330 | 160 | +2/+6 |

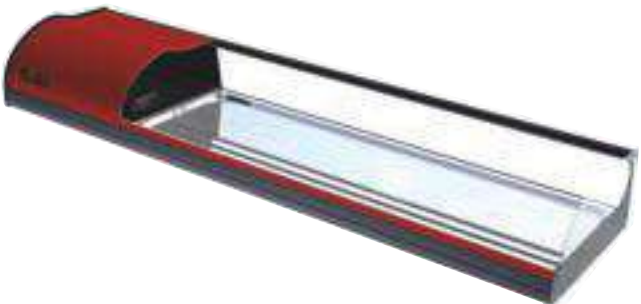

Onix placa fría

| Dimensiones (mm) | Potencia (W) | Temperatura (°C) |
|------------------|--------------|------------------|
| 1146x390x224 | 160 | +2/+6 |
| 1487x390x224 | 160 | +2/+6 |
| 1826x390x224 | 160 | +2/+6 |



Onix sushi

| Bandejas | Dimensiones (mm) | Potencia (W) | Temperatura (°C) |
|----------|------------------|--------------|------------------|
| 4 | 1146x390x224 | 160 | +2/+6 |
| 6 | 1487x390x330 | 160 | +2/+6 |
| 8 | 1826x390x330 | 160 | +2/+6 |



Onix sushi tapa fría

| Dimensiones (mm) | Potencia (W) | Temperatura (°C) |
|------------------|--------------|------------------|
| 1146x390x224 | 160 | +2/+6 |
| 1487x390x224 | 160 | +2/+6 |
| 1826x390x224 | 160 | +2/+6 |

Fregaderos



- Fabricado en acero inoxidable.
- Cubas embutidas.
- Válvula de desagüe y tubo rebosadero incluido.
- Peto posterior.
- Bastidor de acero inoxidable.
- Estantes (1-2) opcionales.
- Longitudes de 600 a 2500 mm.
- Anchos de 500/600/700 mm.
- Varias opciones de cubas (1-2-3) y escurridores (1-2).
- Disponibles modelos con cubas de alta capacidad.

DISTFORM
FOODSERVICE TECHNOLOGY



Grifería



- Gran variedad de modelos.
- Convencionales o ducha.

Lavamanos

- Modelos de pared o pie.



Mesas trabajo



- Encimeras de acero inoxidable satinado.
- Murales (con peto) o centrales (sin peto).
- Patas de 40x40 mm regulables en altura (850/900 mm).
- Estantes (1-2) opcionales.
- Longitudes de 600 a 2400 mm.
- Anchos de 500/600/700/800 mm.
- Cajones y módulos de cajones opcionales.
- Mesas angulares.
- Puertas y ruedas opcionales.



DISTFORM
FOODSERVICE TECHNOLOGY

Máquinas hielo



- Cubito compacto de alta calidad.
- Sistema de fabricación mediante inyectoros metálicos.
- Exterior en acero inox AISI 304 y carrocería monoblock en inox con aislamiento en poliuretano inyectado a alta presión libre de CFC'S.
- Cuba y puerta en ABS alimentario.
- Medidas sin patas, altura pata regulable +/-110-150 mm.
- Entrada agua Ø 3/4 y salida Ø 24 mm.
- Gas refrigerante R404a.
- Tensión / Frecuencia: 220-240V/50 Hz.

Producciones de 20 a 155 kg/día

 **infrico**

Lavavajillas



Lavavasos
Cesta: 40x40 cm.
Ciclos: 90/120/150/180 seg.
Producción: hasta 40 cestas/h.
Brazos de lavado de acero inox.
Dosificadores de líquidos incorporados.



Lavavajillas capota
Cesta: 50x50 cm.
Ciclos: 90/120/150/180 seg.
Producción: hasta 60 cestas/h.
Brazos de lavado de acero inox.
Dosificadores de líquidos incorporados.
Mesas de entrada y salida.



Lavavajillas
Cesta: 50x50 cm.
Ciclos: 90/120/150/180 seg.
Producción: hasta 40 cestas/h.
Brazos de lavado de acero inox.
Dosificadores de líquidos incorporados.



Lavautensilios
Cesta: 67x60 cm.
Ciclos: 120/240/360/540 seg.
Producción: hasta 30 cestas/h.
Brazos de lavado de acero inox.
Dosificadores de líquidos incorporados.

Los nuevos procesos en la cocina

Las cada vez más exigentes normativas alimentarias y la necesidad de ofrecer un producto de calidad con las mayores condiciones higiénicas y sanitarias, ha llevado a la necesidad de la creación nuevos procesos en las cocinas industriales.

Tanto en servicios de catering y grandes salones como en la pequeña y mediana restauración estos procesos son indispensables para mantener tanto la productividad de la cocina como la calidad del producto final.

La combinación de envasadora al vacío, horno mixto y abatidor de temperatura simplifica todas estas necesidades en el mínimo espacio y con la máxima fiabilidad.

Con estos procesos podemos conseguir evitar la aparición de bacterias en el proceso de enfriado y la utilización de técnicas de cocción a baja temperatura con un mínimo de inversión económica y un aprovechamiento eficaz del espacio.



Envasado al vacío



Cocción (65°C-110°C)



Abatir (-20°C)



Cocción (65°C-300°C)



Abatir (-4°C)



Envasado al vacío



Regenerar (65°C)



mychef evolution



Cocción en calor seco De 30 a 300° C



Para cocciones que requieren un aporte continuo de aire caliente seco hasta una temperatura de 300°C, sin humedad. Consigue texturas crujientes, esponjosas y jugosas en carnes asadas, filetes, pescados, precocinados, pizzas y productos de panadería.

Cocción en modo mixto De 30 a 300° C



Para cocciones con calor seco y húmedo a la vez. Permite cocciones más rápidas, más respetuosas con el alimento y con menos mermas, evitando que se resequen los alimentos. El mejor resultado en guisados, asados y gratinados.

Cocción al vapor De 30 a 130° C



mychef evolution genera con la mayor rapidez el vapor más denso del mercado. Además, es el único horno que genera un vapor puro y esterilizado totalmente libre de patógenos. Cocina a baja temperatura, al vapor, pocha, rehoga o blanquea. Obtendrás resultados excelentes en verduras y pescados respetando sus cualidades organolépticas y nutricionales. Y todo ello con un aspecto y color brillantes.

distform
foodservice solutions



MySmartCooking
SISTEMA DE COCCIÓN INTELIGENTE

El sistema de cocción inteligente MySmartCooking hace que cocinar sea más fácil que nunca. Solo tienes que seleccionar el alimento por categoría, escoger el tipo de cocción, y ajustar parámetros como dorado, tamaño y punto. mychef calcula automáticamente el resto.



MyCookingPlanner
COCCIONES SIMULTÁNEAS INTELIGENTES

Con MyCookingPlanner, puedes cocinar simultáneamente alimentos con diferentes tiempos de cocción. La mejor solución para aprovechar al máximo la productividad de tu horno y ahorrar energía.

La opción Multilevel realiza la cocción de varias recetas independientes que se inician al mismo tiempo pero que tienen momentos de finalización. Cada bandeja tendrá su cocción independiente.

Con la opción Just in time podrás realizar múltiples recetas con diferentes tiempos de cocción que necesitas que finalicen al mismo tiempo.



SmartClima Plus
EL SISTEMA DE REGULACIÓN Y COCCIÓN DE VAPOR MÁS AVANZADO

Vapor rápido, denso y seguro.

Gracias a los avanzados sensores de SmartClima Plus, el horno monitoriza hasta diez veces por segundo las condiciones reales de humedad en la cámara de cocción, en función del tipo y la cantidad de alimentos. SmartClima Plus ajusta automáticamente la humedad, inyectando o extrayendo vapor para obtener el resultado deseado, una cocción siempre perfecta.



MyCloud
CONECTA TU Horno CON TU SMARTPHONE

El sistema MyCloud conecta tu horno con tu móvil, tu tablet o tu ordenador. Descárgate la aplicación mychef cloud y gestiona tu horno desde cualquier lugar. O accede al sistema cloud desde el área privada de la web MyCloud, donde puedes también crear, guardar o modificar recetas y enviarlas a tu horno simplemente pulsando un botón.



El sistema patentado TSC (Thermal Stability Control) ofrece una estabilidad de la temperatura en la cámara de cocción sin rival. El resultado son platos con texturas más apetitosas y un gran ahorro energético. El Sistema TSC mide la temperatura en la cámara de cocción varias veces por segundo y transfiere la cantidad de energía necesaria para ofrecer la máxima estabilidad de la temperatura sin apenas oscilaciones ($\pm 0,2^{\circ}\text{C}$).

El resultado es una precisión inigualable en las cocciones a baja temperatura, la cocina al vacío, las deshidrataciones, la pasteurización, y la cocina al vapor. El producto final mantiene todas sus propiedades organolépticas y unos colores más brillantes, todo ello con una menor pérdida de peso, respetando el producto al máximo.



MyCare
SISTEMA DE AUTOLIMPIEZA INTELIGENTE

El sistema de autolimpieza inteligente MyCare elimina cualquier tipo de suciedad automáticamente y sin supervisión.

Según el estado de suciedad de la cámara, MyCare te propone el programa de limpieza más eficiente. Además, gracias al sistema patentado UltraVioletSteam, el último ciclo de lavado genera vapor libre de patógenos por toda la cámara, dejándola esterilizada para una máxima seguridad alimentaria. MyCare hace posible un mayor ahorro energético con un menor consumo de detergente y menos emisiones tóxicas.



Serie S

| Modelo | 6 GN-2/3 | 6 GN-1/1 | 9 GN-1/1 | 6T GN-1/1 |
|-------------|-----------|-----------|-----------|-----------|
| Capacidad | 6 GN-2/3 | 6 GN-1/1 | 9 GN-1/1 | 6 GN-1/1 |
| Comidas/día | 20-80 | 30-100 | 50-150 | 30-100 |
| Ancho | 520 | 520 | 520 | 520 |
| Fondo | 623 | 800 | 800 | 595 |
| Alto | 662 | 662 | 822 | 662 |
| Potencia | 5,6 KW | 7 KW | 10,40 KW | 7 KW |
| Tensión | 230V/400V | 230V/400V | 230V/400V | 230V/400V |

Serie L

Los hornos mychef evolution serie L son la opción perfecta para los grandes restaurantes, hoteles y colectividades. Pensados para atender a un gran número de comensales. Consulte sus características en su distribuidor Hotali@.

Envasadoras vacío

iSensor distform



MODO AUTOMÁTICO

¡Introduce el alimento, baja la tapa y listo!

Envasar nunca ha sido tan fácil. Con el modo automático de iSensor, simplemente introduce el alimento dentro de la bolsa y baja la tapa. No es necesario configurar ningún parámetro ni hacer reajustes. La envasadora inteligente iSensor calcula el vacío perfecto según el tipo de alimento, el espesor de la bolsa y las condiciones atmosféricas. Sus sensores inteligentes controlan todo el proceso y el resultado es siempre el mismo. Un envasado perfecto y eficiente, sin ningún tipo de supervisión.



MODO MANUAL

Vac +

Vacío extra para alimentos porosos. Añade un tiempo de vacío adicional una vez alcanzado el 100% de vacío y fuerza la salida del aire del interior de los alimentos porosos. Una aplicación muy interesante son las impregnaciones, técnica que sustituye el aire del alimento poroso por un líquido.

Envasado con gas inerte

Para alimentos frescos o delicados. Envasa cualquier tipo de alimento respetando la seguridad alimentaria y garantizando la calidad de los alimentos frescos más delicados: pescado, mariscos, verduras....

Soft Air

Para el envasado de alimentos delicados o especiales. Entrada progresiva del aire para una mejor adaptabilidad de la bolsa de vacío al producto a envasar. Ideal para productos que pueden deformarse o romperse con el envasado.



| Modelo | Medidas exteriores (mm) | Bomba de vacío (m ³ /h) | Alimentación (V/L+N/Hz) | Potencia (KW) | Medidas cámara (mm) | Longitud soldadura (mm) | Posición barra soldadura |
|--------|-------------------------|------------------------------------|-------------------------|---------------|---------------------|-------------------------|--------------------------|
| S | 388x491x382 | BUSCH 6 | 230/L+N/50-60 | 0,25 | 328x385x162 | 315 | |
| M | 475x561x454 | BUSCH 10 | 230/L+N/50-60 | 0,30 | 412x453x200 | 405 | |
| M | 475x561x454 | BUSCH 16 | 230/L+N/50-60 | 0,55 | 412x453x200 | 405 | |
| M | 475x561x454 | BUSCH 20 | 230/L+N/50-60 | 0,75 | 412x453x200 | 405 | |
| L | 620x571x469 | BUSCH 20 | 230/L+N/50-60 | 0,75 | 560x465x210 | 455 | |
| L | 620x571x469 | BUSCH 20 | 230/L+N/50-60 | 0,75 | 560x465x210 | 455+455 | |



TekChill distform

El abatidor de temperatura TekChill es un valioso aliado en las cocinas profesionales, permite mantener intacta la frescura de los alimentos con la máxima higiene y flexibilidad, planificar la producción y evitar desperdicios permitiendo considerables beneficios en términos de tiempo y reducción de costes.

- Fabricados en acero inoxidable AISI 304 en estructura monobloc.
- Panel de control digital y teclado de membrana.
- Sonda corazón, incluida.
- Control por tiempo o por sonda.
- Cambio de mano en puerta, opcional.
- Guías extraíbles y cantos redondeados para una fácil limpieza.
- Incorpora desagüe en la parte inferior.
- Sistema automático de descarche.
- Pase automático a fase de mantenimiento al final del ciclo.
- Ciclo de pre-enfriamiento a -30°C.
- Para bandejas de dimensiones GN 1/1 (todos los modelos) y EN (600x400) especial pastelería en modelos 5 GN 1/1 T, 10 GN 1/1 y 15 GN 1/1.



Abatimiento positivo

El abatimiento positivo permite proteger los alimentos contra la agresión bacteriana, prolongando su periodo de conservación y evitando pérdidas de peso en los productos. La temperatura en el corazón de los alimentos pasa de 90°C a 3°C en 90 minutos.

Abatimiento negativo

El proceso de abatimiento negativo (congelación) se realiza mediante la formación de microcristales que mantienen intacta la estructura celular del alimento, garantizando así su conservación durante un largo periodo de tiempo. La temperatura en el corazón de los alimentos pasa de 90°C a -18°C en 240 minutos.



| Modelo | Medidas totales (mm) | Capacidad | Tensión (V/L+N/Hz) | Potencia (W) | Potencia frigorífica (W) | Rendimiento +3/-18°C |
|----------------------------|----------------------|-----------------------------|--------------------|--------------|--------------------------|----------------------|
| TekChill 3GN 1/1 | 650x670x670 | 3GN 1/1 | 230/1/50 | 975 | 613 | 10/7 kg |
| TekChill 5GN 1/1 Long.* | 520x850x880 | 5GN 1/1 L | 230/1/50 | 1185 | 807 | 15/10 kg |
| TekChill 5GN 1/1 Transv.** | 800x700x900 | 5GN 1/1 T 5 EN (600x400) | 230/1/50 | 1185 | 807 | 18/11 kg |
| TekChill 10GN 1/1 | 800x780x1700 | 10GN 1/1 10 EN (600x400) | 230/1/50 | 2010 | 1547 | 34/22 kg |
| TekChill 15GN 1/1 | 800x780x2000 | 15GN 1/1 15 EN (600x400) | 400/3L+N/50 | 3820 | 2933 | 50/38 kg |

* Ideal para el apilado de un horno MyChef / ** Ideal para el apilado de un horno MyChef T

Botelleros refrigerados



- Refrigeración R134a.
- Interior y exterior en acero inoxidable.
- Fondo embutido con desagüe.
- Evaporador estático de cobre y aletas de aluminio.
- Control de temperatura por termostato.
- Patas regulables en altura.
- Compresor hermético ventilado.
- Separadores verticales en rejilla de acero platinado.
- Fondo: 550 mm.
- Longitudes: 1000/1500/2000 mm.
- Puertas: 2/3/4.
- Temperatura de trabajo: +2°C/+6°C.

Mesas refrigeradas



- Refrigeración R134a.
- Control electrónico y digital de la temperatura de desercarche.
- Patas de acero regulables en altura.
- Interior y exterior en acero inox AISI 201.
- Trasera en galvanizado.
- Dispositivo automático de cierre.
- Compresor hermético ventilado.
- Evaporador de tubo de cobre.

Opciones

- Ruedas.
- Fregadero.
- Puertas de cristal.
- Kit cajones, (uno o más módulos).
- Encimera granito.



Armarios refrigerados



MÚLTIPLES POSIBILIDADES

- De 1 a 6 puertas.
- Refrigeración y congelación.
- Medidas estándar o gastronorm.
- Refrigeración o congelación.
- Armarios especiales para pescado.
- Puertas de cristal.



Cocción



- Líneas de cocción modulares con todos los elementos necesarios.
- Murales 550/750/900 mm de fondo.
- Centrales.



- Cocina.
- Frytop.
- Freidora.
- Baño maría.
- Marmitas.
- Sartén Basculante.
- Neutros.
- Muebles bajos para elementos de sobremesa.
- Planchas.
- Cuecepastas.

 **TECNOINOX**

TEXTIL Y VESTUARIO

*Textile and Clothing • Textile et Vêtements
Tessile e Abbigliamento • Textil und Kleidung*



Vestuario

chaqueta cocinero



Ref. 908- Manga Corta
 Color blanco
 Sarga 200 gr/m²
 65% poliéster - 35% algodón
 Tallas: XS-S-M-L-XL-XXL-YL
 Unisex
 Boton Forrado



Ref. 907 - Manga Larga
 Color blanco
 Sarga 200 gr/m²
 65% poliéster - 35% algodón
 Tallas: XS-S-M-L-XL-XXL-YL
 Unisex
 Boton Forrado

Ref. 917M
 Color negro
 Popelin 120 gr/m²
 65% poliéster - 35% algodón
 Tallas: XXS-XS-S-M-L-XL-XXL-YL
 Unisex
 Boton Cosido

Ref. 916
 Color blanco
 Popelin 120 gr/m²
 65% poliéster - 35% algodón
 Tallas: XXS-XS-S-M-L-XL-XXL-YL
 Unisex
 Boton Cosido



Ref. 9307 Teramo
 9 colores
 Sarga 200 gr/m²
 65% poliéster - 35% algodón
 Tallas: XS-S-M-L-XL-XXL-YL
 Unisex
 Botón Chupete



Ref. 9191 - Catania
 9 colores
 Sarga 200 gr/m²
 65% poliéster - 35% algodón
 Tallas: XS-S-M-L-XL-XXL-YL
 Chica
 Botón Chupete



Rojo - 105



Fucsia - 125



Malva - 119



Morado - 136



Turquesa - 115



Verde - 121



Albero - 128



Gris Perla - 117



Gris Marengo - 139



pantalon cocinero



Ref. 770
 Color Raya Luto
 Vichy 118 gr/m²
 65% poliéster - 35% algodón
 Tallas: 36-64
 Unisex



Ref. 771
 Color Cuadro Marino
 Vichy 118 gr/m²
 65% poliéster - 35% algodón
 Tallas: XXS-XS-S-M-L-XL-XXL-YL
 Unisex



Pantalón microfibra
 Antibacterias. Repelente a los líquidos. Alta transpirabilidad. No necesita planchar. No se alteran los colores. Tolerancia a salpicaduras de lejía. Seca muy rápido. Lavable a 90°.

Ref. 7006
 Goma y cordón
 5 Colores
 Microfibra 148 gr/m²
 100% poliéster
 Tallas: XS-S-M-L-XL-XXL-YL
 Unisex



Gorros



GORRO GRAN CHEF

Ref. 4481V
 16 colores
 65% poliéster - 35% algodón
 Tallas: Única
 Regulable con velcro
 Unisex



Ref. 4482V
 17 diseños
 65% poliéster - 35% algodón
 Tallas: Única
 Regulable con velcro
 Unisex



Delantales

Delantal Francés con Bolsillo



Ref. 118B
90x75 cm
Sarga 200 gr/m²
65% poliéster - 35% algodón
Tallas: Única
Unisex



Delantal Peto con bolsillo



Ref. 116BC
90x75 cm
Sarga 200 gr/m²
65% poliéster - 35% algodón
Tallas: Única
Unisex

Delantal sin Peto con bolsillo



Ref. 11745B
50x75 cm
Sarga 200 gr/m²
65% poliéster - 35% algodón
Tallas: Única
Unisex



Bandanas



Ref. 4471
Múltiples colores y diseños
65% poliéster - 35% algodón
Tallas: Única
Unisex



Camisas



Ref. 2658
Popelin 120 gr/m²
65% poliéster - 35% algodón
Tallas: 38-50
Chico

Ref. 2481
Popelin 120 gr/m²
65% poliéster - 35% algodón
Tallas: XS-S-M-L-XL-XXL-YL
Chica



pantalones



Ref. 2035
Sarga Bioelástica 225 gr/m²
96% poliéster - 4% elastano
Tallas: 36-56
Negro-Marino-Gris Marengo
Chica

Ref. 7779
Micofibra 135 gr/m²
100 % poliéster
Tallas: 36-60
Negro
Chico

chaqueta cocinero gama alta



Hermes - 9320
Blanco
100 % algodón - 170 gr/m²
Tallas: XS-YL
Chico

Galatea - 9334
Blanco
100 % algodón - 170 gr/m²
Tallas: XS-XXL
Chica

Zeus - 9323
Blanco/Negro
100 % algodón - 170 gr/m²
Tallas: XS-YL
Chico



Icaro - 9330
Blanco/Negro
100 % algodón - 170 gr/m²
Tallas: XS-YL
Chico



**GASTRO
CHEF**

Carites - 9346
Negro
65 Poliester - 35 % algodón 210 gr/m²
Tallas: XS-YL
Chico

Artemisa - 9355
Blanco
65 Poliester - 35 % algodón 210 gr/m²
Tallas: XS-XXL
Chica





Calzado pensado para actividades que requieren estar mucho y tiempo de pié, con una durabilidad, ergonomía y diseño del más alto nivel.

- Antideslizante.
- Lavable.
- Absorción de energía en el talón.
- Confort articular y térmico (elimina casi el 90% del calor que genera el pié).
- Impermeable.
- Resistente a químicos.

mycodeor



Diseño original y sencillo. Ligero y flexible.
Colores: Blanco-Negro
Tallas: de 34 a 48



Planeta



Destinado especialmente para uso femenino. Perfecto para uso en sala, recepción o congresos.
Colores: Negro
Tallas: de 35 a 42



sírío



Perfecta ergonomía y ajuste al pié. Atractivo diseño indicado para actividades de cara al público. Extremada sensación de comodidad y ligereza.
Colores: Negro-Marrón
Tallas: de 34 a 48



velcro



Sistema de cierre mediante solapa de velcro. Gran sujeción. Ligero y flexible, adecuado para cocinas, office y personal sanitario.
Colores: Negro-Blanco
Tallas: de 35 a 46



seguridad



Protección en puntera. Destaca por su extraordinaria ligereza, inusual en zapatos de este nivel de protección. Su comodidad contrasta con la rigidez del zapato tradicional de seguridad.
Colores: Negro-Blanco
Tallas: de 35 a 48



Mantelería



Cuadro clásico

50% poliéster / 50% algodón
Ancho pieza: 3,20 m
Diseño clásico



Marrón



Crema



Amarillo



Verde



Rojo



Azul



París

65% poliéster / 35% algodón
Ancho pieza: 3,20 m



Lila



Royal



Negro



Vino



Arena



Cobre



Mercurio



Verde



Arena 2



Corteza



carré

65% poliéster / 35% algodón

Ancho pieza: 3,20 m

Diseño informal

Reversible

Fácil lavado



Cobre



Arena



Negro



Verde



rústico

50% poliéster / 50% algodón

Ancho pieza - 3,20 m

Bajo peso

Baja fijación de manchas

Fácil lavado

Extraordinaria solidez de los colores



Blanco



Crudo



Lino



Blanco



Cuerda



Vainilla



Naranja



Rioja



Avellana



Chocolate



Gris



Negro

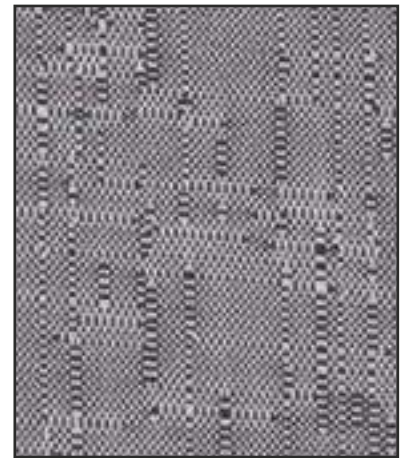

satén

50% poliéster / 50% algodón

Ancho pieza: 3,20 m

Amplísimo colorido - Alto gramaje - Artículo clásico



Arena



Amarillo



Añil



Azu



Azul Marino



Azul



Azulón



Negro



Naranja



Oro



Pistacho



Rioja



Rojo



Salmón



Tabaco



Teja



Vainilla



Verde Botella



Verde



Marrón



Gris Perla



Beige



Berenjena



Blanco



Burdeos



Chocolate



spiral

65% poliéster / 35% algodón

Ancho pieza: 3,20 m

Diseño informal

Colores actuales

Reversible

Fácil lavado



Royal



Negro



Arena



Corteza



Crema



Rosa Palo



Vino



CONSUMIBLES

Consumables • Consommables
Materiali di Consumo • Verbrauchsmaterial



Aparatos



Secamanos



| Código | Descripción | Serie |
|-----------------|---|-------|
| AA13000 | Secamanos pulsador | ABS |
| AA14000 | Secamanos óptico | ABS |
| AA19000/AA19600 | Secamanos ave óptico alto rendimiento blanco/negro | ABS |
| AA25050/AA25650 | Secamanos alto rendimiento jet tifon blanco/negro | ABS |
| AA25550/AA25950 | Secamanos alto alto rendimiento jet tífón plata/grafito | ABS |
| AA15000/15500 | Secamanos pulsador inox satinado/brillo | INOX |
| AA16500/16000 | Secamanos óptico inox satinado/brillo | INOX |
| AA18000/AA18500 | Secamanos ave óptico alto rendimiento brillo/satinado | INOX |



Serie Smart



| Código | Descripción | Serie |
|-----------------|---|-------|
| AE57000/AE57600 | Dispensador industrial higiénico blanco/negro | SMART |
| AG47000/AG47600 | Dispensador de papel mecha blanco/negro | SMART |
| AH37000/AH37600 | Dispensador de toallas zig-zag blanco/negro | SMART |
| AC27050/AC27650 | Jab. depósito smart Jofel blanco/negro | SMART |
| AC96000 | Jab. depósito smart Jofel | SMART |



Serie ABS



| Código | Descripción | Serie |
|---------------------|--|-------|
| AC70000/70600 | Jabonera Aitana blanco/negro | ABS |
| AC79000/AC79500 | Jabonera Aitana inox brillo/satinado | ABS |
| AC91050 | Dosificador óptico depósito jabón rellenable | ABS |
| AC91060 | Dosificador óptico depósito espuma rellenable | ABS |
| AC91000 | Dosificador óptico depósito con carga | ABS |
| AH33000 | Toallero azur | ABS |
| AG21050 | Box secamanos mecha clásico fume | ABS |
| AG40000 | Box secamanos | ABS |
| AG16500/AG15500 | Dispensador palanca blanco/fume | ABS |
| AG17550/AG18550 | Dispensador automático top blanco/fume | ABS |
| AG56000/56600/57000 | Disp. papel autocortante ABS blanco/negro/fume | ABS |



Serie Inox



| Código | Descripción | Serie |
|-----------------|--|-------|
| AC54000/54500 | Jabonera futura Inox satinada/brillo | INOX |
| AC79000/AC79500 | Jabonera Aitana inox brillo/satinado | INOX |
| AE25000/25500 | Portarrollos futura inox satin./brillo | INOX |
| AH25000/25500 | Toallero futura inox satinado/brillo | INOX |
| AG45000/45500 | Disp. mecha box satinado/brillo | INOX |
| AG59000 | Disp. papel autocortante | INOX |



Celulosa



Bobina secamanos

| DESCRIPCIÓN | EMBALAJE |
|----------------------------------|----------|
| Bobina 2/C pasta celulosa 1 kg | 6 U. |
| Bobina 2/C pasta celulosa 1,2 kg | 6 U. |
| Bobina 2/C pasta Eco 1,2 kg | 6 U. |
| Bobina 2/C pasta Eco 1 kg | 6 U. |



Higiénico industrial



| DESCRIPCIÓN | EMBALAJE |
|-----------------------------------|----------|
| Bobina 2/C pasta celulosa 0,45 kg | 18 U. |
| Bobina 2/C Eco 0,45 kg | 18 U. |

Bobina industrial

| DESCRIPCIÓN | EMBALAJE |
|--------------------------------|----------|
| Bobina 2/C pasta celulosa 6 kg | 2 U. |
| Bobina 2/C Eco 5 kg | 2 U. |



Toallas secamanos



| DESCRIPCIÓN | PAQUETE | EMBALAJE |
|----------------------------|---------|----------|
| Toalla Z reciclada natural | 196 | 3.920 U. |
| Toalla Z reciclada blanca | 196 | 3.920 U. |
| Toalla tisú 2 C | 196 | 3.920 U. |

Higiénico doméstico

| DESCRIPCIÓN | METROS BOBINA | EMBALAJE |
|--|---------------|----------|
| Higiénico doméstico 2/C pasta celulosa | 36 | 96 U. |



Servilletas Tisú



| COLORES | 17x17 TISÚ 1 CAPA MINISERVIS | 20x20 TISÚ 2 CAPAS |
|---------|--|---|
| | 400 unidades paquete 16.000 unidades caja 24 cajas palet | 100 unidades paquete 5.000 unidades caja 24 cajas palet |
| | X | X |
| | X | X |
| | | X |
| | | X |



| COLORES | 30x30 TISÚ 1 CAPA | 30x30 TISÚ 2 CAPAS |
|---------|---|---|
| | 100 unidades paquete 4.000 unidades caja 28 cajas palet | 100 unidades paquete 3.200 unidades caja 24 cajas palet |
| | X | X |



| COLORES | 33x33 TISÚ 1 CAPA | 33x33 TISÚ 2 CAPAS |
|---------|---|---|
| | 100 unidades paquete 4.800 unidades caja 15 cajas palet | 100 unidades paquete 3.000 unidades caja 20 cajas palet |
| | X | X* |
| | | X |
| | | X |
| | | X |
| | | X |
| | | X |
| | | X |

*50 Serv. paquete, 800 serv. caja 72 cajas palet

| COLORES | 40x40 TISÚ 2 CAPAS | 40x40 TISÚ 2 CAPAS PLEGADO 1/8 |
|---------|---|---|
| | 100 unidades paquete 2.400 unidades caja 20 cajas palet | 100 unidades paquete 2.400 unidades caja 15 cajas palet |
| | X | X |
| | X | |
| | X | |
| | X | |
| | X | |
| | X | |
| | X | |
| | X | |
| | X | |



Celulosa



Servilletas punta&punta

Las servilletas Punta&Punta tienen más resistencia y cuerpo que una servilleta dos capas convencional. El acabado Punta&Punta se caracteriza por la unión de las dos capas de las servilletas mediante una gota de cola, este tipo de gofrado mejora la apariencia de la servilleta y hace que las capas no se separen. Este sistema de unión de capas también aumenta la capacidad de absorción, con lo que se mejora el rendimiento de la servilleta. Las servilletas Punta&Punta reducen el consumo facilitan el ahorro.



COLORES



40x40 P&P
2 CAPAS

100 unidades paquete
1.600 unidades caja
20 cajas palet

| | | |
|--|----------|---------|
| | BLANCO | T222150 |
| | CARAMEL | T222156 |
| | CREMA | T222181 |
| | AMARILLO | T222177 |
| | GRIS | T222178 |
| | ROSA | T222182 |
| | NARANJA | T222174 |
| | KIWI | T222176 |
| | FUCSIA | T222180 |
| | ROJO | T222153 |
| | TURQUESA | T222183 |
| | AZUL | T222152 |
| | VERDE | T222159 |
| | BURDEOS | T222151 |
| | CACAO | T222157 |
| | NEGRO | T222154 |

Manteles celulosa blanco

MANTEL DE CELULOSA CORTADO

Celulosa 37 gr.

REFERENCIA Medidas Embalaje



| | | |
|----------|----------------|-----------|
| W240100* | Mantel 30x40 | 500 ud. |
| W241100 | Mantel 35x49 | 1.000 ud. |
| W241600 | Mantel 80x80 | 500 ud. |
| W241912 | Mantel 100x100 | 500 ud. |
| W242000 | Mantel 100x120 | 500 ud. |
| W242100 | Mantel 120x120 | 500 ud. |
| W241940 | Mantel 100x140 | 400 ud. |

* Manteles 30 x 40 con cenefa consultar.

MANTEL DE CELULOSA ROLLO BLANCO

Celulosa 37 gr.

REFERENCIA Medidas Celulosa Embalaje

| | | | |
|----------|-----------------------------|--------|-------|
| R251192 | Rollo mantel 100 cm x 50 m | 37 gr. | 1 ud. |
| R251095 | Rollo mantel 100 cm x 100 m | 37 gr. | 1 ud. |
| R258990 | Rollo mantel 120 cm x 10 m | 48 gr. | 1 ud. |
| R251201 | Rollo mantel 120 cm x 25 m | 48 gr. | 1 ud. |
| R251202 | Rollo mantel 120 cm x 50 m | 48 gr. | 1 ud. |
| R251207* | Rollo mantel 120 cm x 100 m | 48 gr. | 1 ud. |

* Colores a consultar en la medida 120 cm x 100 m

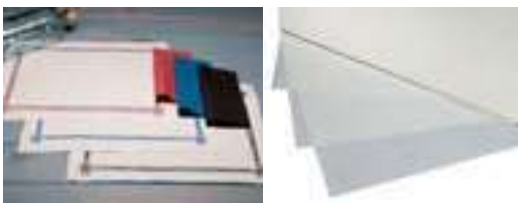

La gama GC Class de servilletas y manteles en Tisuclass es la marca del grupo para vestir la mesa con distinción. El Tisuclass es un material de un solo uso no excluyente de la tela, ya que se puede utilizar como complemento de la misma. Cada vez más el ambiente, la atmósfera, o el entorno tienen mayor valor diferenciador a la hora de prestar servicios de restauración.

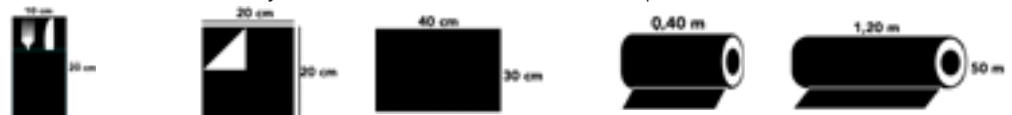

| MESA CLASS COLORES | | KANGUR 40x40 cm. | SERVILLETAS 40x40 cm. | MANTELES 30x40 cm. | DUETO 0,40x50 m. | ROLLO MANTEL 1,20x50 m. |
|---------------------------------------|-----------|---------------------|--------------------------|-----------------------|---|---|
| Uds. paquete/Uds. caja Cajas palet | | 50 / 600 49 | 50 / 600 49 | 300 54 | 3 rollo caja/60rollos box 2 box palet | 1 rollo caja/20rollos box 2 box palet |
| | BLANCO | | T224050 | W230099 | R251243 | R251197 |
| | STONE | T260098 | T224065 | | R251296 | |
| | GRIS | T260007 | T224062 | | R251254 | R251220 |
| | CARAMEL | T260009 | T224054 | W230411 | R251248 | R251219 |
| | KIWI | T260006 | T224060 | W230410 | R251251 | R251222 |
| | TERRACOTA | T260012 | T224053 | W230406* | R251245 | R251215 |
| | ROJO | T260013 | T224051 | | R251247 | R251217 |
| | TURQUESA | T260011 | T224064 | | R251258 | R251224* |
| | AZUL | T260014 | T224055 | W230402* | R251244 | R251198 |
| | BURDEOS | T260004 | T224057 | W230409 | R251242 | R251195 |
| | BERENJENA | T260005 | T224061 | W230408 | R251250 | R251221 |
| | CACAO | T260008 | T224059 | W230412 | R251249 | R251218 |
| | GRAFITO | T260010 | T224063 | W230414 | R251257 | R251223* |
| | NEGRO | T260003 | T224052 | W230405 | R251246 | R251216 |
| | CENEFA | | | W230103 | | |

* Bajo pedido. Consultar tiempo de entrega.



| PREMIUM | SERVILLETAS 20x20 cm.* | SERV. 30x40 cm. Plegado 1/6 | SERV. 40x40 cm. Plegado 1/8 | KANGUR 34x40 cm. | KANGUR 47x47 cm. | SERVILLETAS 47x47 cm. |
|---------------------------------------|---------------------------|-----------------------------------|-----------------------------------|---------------------|---------------------|--------------------------|
| Uds. paquete/Uds. caja Cajas palet | 60 / 2160 49 | 70 / 840 49 | 50 / 600 49 | 50 / 600 49 | 50 / 500 49 | 50 / 500 49 |
| | BLANCO | T202000 | T261121 | T260018 | T261125 | T224147 |
| | BURDEOS | T202001 | | | | |
| | NEGRO | T202002 | | T260019 | | |

* Cada caja de servilletas 20 x 20 incluye 8 cajas dispensadoras.

TisuClass
AIRLAID

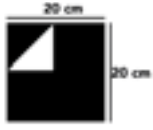

SERV. SIENA
40x40 cm.

SERV. PARÍS
40x40 cm.

SERV. LUXE
40x40 cm.

SERV. CON
CENEFA 40x40
cm.

KANGUR
SIDNEY
40x40 cm.

KANGUR
SIENA
40x40 cm.

Uds. paquete/Uds. caja
Cajas palet

50 / 600
49

50 / 600
49

50 / 600
49

50 / 600
49

50 / 600
49

50 / 600
49

| | | | | | | | |
|--|---------|---------|---------|---------|---------|---------|---------|
| | BLANCO | T221440 | | T221436 | | T260000 | T000505 |
| | GRIS | T221442 | | | | | T000506 |
| | CARAMEL | T221443 | | | | | T000507 |
| | NEGRO | | T221452 | | | T260001 | |
| | BURDEOS | | T221457 | | T221447 | T260002 | |

Línea Ecológica

Ecológico es una nueva gama de productos tisú hecha a partir de 100% fibra reciclada. El papel que utilizamos se fabrica a partir de las fibras de celulosa presentes en los envases de cartón, lo que le confiere un característico color marrón.



| | | | | | | | |
|--|--------------------------|---|--------------------------|-------------------------------------|--------------------------|------------------------------------|---------|
| Servilletas Línea Ecológica | 40x40 cm. P&P 2 capas | 30x40 cm. P&P 2 capas Plegado 1/6 | 33x33 cm. P&P 2 capas | 30x40 cm. 2 capas Maxi servis | 20x20 cm. P&P 2 capas | 17x17 cm. 1 capa Mini servis | |
| Uds. paquete/Uds. caja Cajas palet | 100 / 1.600 20 | 75 / 2.400 20 | 50 / 1.500 20 | 50 / 1.500 20 | 100 / 3.000 42 | 400 / 16.000 24 | |
| | NATURE | T222001 | T222002 | T223300 | T221050 | T972000 | T221099 |



Nature
Ecofriendly paper



| | | | | | | |
|-------------------------------------|--------------------------------------|--------------------------------------|--|--|--|---------|
| Manteles Línea Ecológica | MANTEL KRAFT 30x40 cm. 48 grs. | MANTEL KRAFT 35x49 cm. 48 grs. | MANTEL KRAFT 100x100 cm. 48 grs. | MANTEL KRAFT 120x120 cm. 48 grs. | DUETO KRAFT 0,40x50 48 grs | |
| Uds. caja Cajas palet | 2x500 48 | 1.000 60 | 3x100 22 | 300 18 | 3 rollos caja 60 rollos box/ 2 box palet | |
| | NATURE | W240402 | W241202 | W242200 | W242300 | R251266 |

Mantelines

Material 100% reciclado. Impreso con tintas compostables.



| REF. | TAMAÑO | g/m2 | PACK | CARTÓN/MÍN. |
|--------|-------------|------|--------|-------------|
| 106.40 | 31 x 43 cm. | 48 | 500 u. | 2.000 u. |
| 106.12 | 31 x 43 cm. | 48 | 500 u. | 2.000 u. |



Ref.: 106.12

Ref.: 106.40



| CM | CARTÓN | 1 COL | | | | 2 COL | | | 3 COL | |
|---------|---------|-------|------|------|-------|-------|------|-------|-------|-------|
| | | 10 C | 20 C | 50 C | 100 C | 20 C | 50 C | 100 C | 50 C | 100 C |
| 31 X 43 | 2.000 U | X | X | X | X | X | X | X | X | X |

Bolsas SOS kraft natural con asas tipo cordel. Personalizadas.

| | cm | Anónimas | Decoradas |
|---|-------------|----------|-----------|
| Bolsas SOS kraft natural 80 g/m ² Cartón/mín. 250 U. | 20 +10 x 29 | 109.19 | 142.59 |
| | 25 +14 x 32 | 109.20 | 142.60 |
| | 32 +16 x 31 | 109.23 | 214.15 |
| | 32 +16 x 43 | 109.22 | 109.22 |



Personalización: precios a consultar en función de la cantidad y número de colores.
Impresión semi-artesanal mediante repicaje (pequeñas cantidades).
Impresión simultánea a la fabricación de las bolsas (grandes cantidades).

Feel Green
Ref.: 142.59



Sin decoración
Ref.: 109.23



Sin decoración
Ref.: 109.19



Arpillera
Ref.: 214.15



Celulosa



Tejido sin tejer 70 g/m² para un solo uso.

Composición: Viscosa y celulosa. Producto de altísima calidad, suave, resistente.

Homogeneidad, tacto agradable y buena resistencia en seco y en húmedo. Parece tela. Certificado de contacto alimentario.



| UNICOLOR 70 g/m ² | CANGURO 40x40 cm | SERVILLETAS 20x20 cm. | SERVILLETAS 40x40 cm. | SERVILLETAS 40x40 cm. | ROLLO MANTEL 1,20x25 m. | TU Y YO 0,40x24 m. | MANTELÍN 30x40 cm. |
|---------------------------------|---------------------|--------------------------|--------------------------|--------------------------|----------------------------|---------------------------------------|-----------------------|
| Pack/ cartón mínimo | 30 U 720 U | 100 U 3.600 U | 50 U 600 U | 50 U 600 U | 1 rollo | 20 formats 0,40x1,20 m 6 rollos | 200 U 800 U |
| FUCSIA | | | 195.71 | | 195.74 | 195.77 | |
| GRIS | | | 195.70 | 213.56 | 195.73 | 195.76 | 221.47 |
| CREMA | 203.93 | 203.90 | 179.36 | 213.59 | 179.43 | 179.52 | 179.60 |
| CHOCOLATE | 203.92 | 203.89 | 179.27 | 213.61 | 179.42 | 179.49 | 179.59 |
| MANDARINA | | | 193.86 | | 193.87 | 193.88 | |
| PISTACHO | | | 193.38 | | 179.45 | 179.55 | |
| PARMA | | | 179.39 | 213.62 | 179.46 | 179.56 | 179.70 |
| TURQUESA | | | 194.82 | | 194.83 | 194.84 | |
| CLARETE | | | 179.37 | 213.63 | 179.44 | 179.53 | 179.66 |
| AZUL MARINO | | | 802.19 | | | | |



Modelo Aurora



| LIKE-LINEN AURORA 70 g/m ² | | MEDIDAS | PACK | CARTÓN/MIN. |
|---|------------------|------------|------|-------------|
|  | SERVILLETAS | 40x40 cm | 50 U | 600 U |
|  | ROLLOS DE MANTEL | 1,20x8 m | - | 9 R |
| | | 1,20x25 m | - | 1 R |
|  | MANTELES FORMATO | 100x100 cm | 20 U | 200 U |
| | | 120x120 cm | 20 U | 200 U |

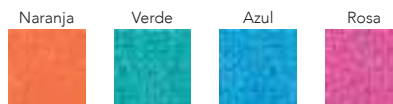

Envoltorios para recipientes de presentación



Impresas con tintas al agua. Papel antigrasas fino 32 g/m². Pack: 1.000 U., Cartón/mínimo: 4.000 U.



| ENVOLTORIOS AMERICAN STYLE | Fitipaldi rojo | Fitipaldi negro | Times | Feel Green 34 g/m ² |
|----------------------------|----------------|-----------------|--------|--------------------------------|
| 31 X 31 cm | 186.28 | 186.29 | 186.30 | 186.31 |
| 31 X 38 cm | 186.32 | 186.33 | 186.34 | 186.35 |

Personalización: Precios a consultar en función de la cantidad y número de colores. Pedido mínimo: 28.000 U.

Cajas americanas estancas





Envases de alta calidad para platos preparados, pastelería

Con ventana

| Colores | 1.350 ml Pack: 50 U. Cartón/min.: 300 U. Base inf.: 15,3 x 12,1 cm. Base sup.: 17,2 x 13,9 cm. Altura: 6,4 cm. | 1.980 ml Pack: 50 U. Cartón/min.: 200 U. Base inf.: 19,8 x 14 cm. Base sup.: 21,7 x 16 cm. Altura: 6,4 cm. |
|------------|---|---|
| | Volare | -- |
| Blanco | 216.68 | -- |
| Negro | 216.69 | 205.43 |
| Feel green | -- | 205.44 |
| Neutro | 216.70 | -- |



Sin ventana

| | 780 ml (280 + 18 PE g/m ²) Pack: 50 U. - Cartón/min.: 450 U. Base inf.: 11,2 x 9 cm. Base sup.: 12,7 x 11,5 cm. Altura: 6,4 cm. | 1.350 ml (305 + 18 PE g/m ²) Pack: 50 U. - Cartón/min.: 300 U. Base inf.: 15,3 x 12,1 cm. Base sup.: 17,2 x 13,9 cm. Altura: 6,4 cm. | 1.470 ml (305 + 18 PE g/m ²) Pack: 50 U. - Cartón/min.: 200 U. Base inf.: 19,8 x 14 cm. Base sup.: 21,5 x 15,8 cm. Altura: 4,8 cm. | 1.980 ml (305 + 18 PE g/m ²) Pack: 50 U. - Cartón/min.: 200 U. Base inf.: 19,8 x 14 cm. Base sup.: 21,7 x 16 cm. Altura: 6,4 cm. | 2.910 ml (305 + 18 PE g/m ²) Pack: 35 U. - Cartón/min.: 140 U. Base inf.: 21,7 x 21,7 cm. Base sup.: 23,6 x 23,6 cm. Altura: 6,4 cm. |
|---|---|--|--|--|--|
|  | 211.44 | 216.65 | 211.45 | 211.46 | 211.47 |
|  | 131.57 | 216.66 | 131.58 | 131.59 | 131.61 |
|  | 131.74 | -- | 131.75 | 131.76 | -- |
|  | 221.17 | 216.67 | 221.18 | -- | -- |

Personalización: Precios a consultar en función de la cantidad y número de colores.

Palillos



Ref.: 0010016



Ref.: 1010125

| Referencia | Descripción | mm. | Contenido aprox. | Embalaje |
|------------|------------------------------------|-----------|------------------|--------------------------|
| 1320014 | Palillo redondo 2 puntas "Picnic" | 65 x 2 | 800 U. | 100 estuches (5 x 20) |
| 1010115 | Palillo redondo 1 punta | 100 x 2,2 | 500 U. | 100 estuches (5 x 20) |
| 0010016 | Palillo redondo 2 puntas | 65 x 2 | 130 U. | 240 palilleros (10 x 24) |
| 1010032 | Palillo redondo 2 puntas enfundado | 65 x 2,2 | 1.000 U. | 30 estuches (6 x 5) |
| 1010125 | Palillo redondo 2 puntas enfundado | 65 x 2 | 1.000 U. | 30 estuches (6 x 5) |

Brochetas

| Referencia | Descripción | mm. | Contenido aprox. | Embalaje |
|------------|-----------------|-----------|------------------|----------------------|
| 1010133 | Pincho brocheta | 100 x 2,2 | 200 U. | 150 bolsas (10 x 15) |
| 1010068 | Pincho brocheta | 200 x 3 | 50 U. | 100 bolsas (2 x 50) |



Ref.: 1010133

Cañas



Ref.: 1010173

| Referencia | Descripción | cm. | Contenido aprox. | Embalaje |
|------------|--------------------------------|---------|------------------|----------------------|
| 1010173 | Caña recta negra | | 100 U. | 100 bolsas (10 x 10) |
| 1010186 | Caña recta colores con cuchara | | 100 U. | 100 bolsas (10 x 10) |
| 1010191 | Caña flexible negra | 230 x 6 | 100 U. | 100 bolsas (10 x 10) |

Ecoline

| Referencia | Descripción | Contenido aprox. | Embalaje |
|------------|-------------------------|------------------|----------|
| 1010168 | Conos de madera 13 cm. | 100 U. | 25 PVC |
| 1010207 | Barcos de madera 22 cm. | 50 U. | 25 PVC |



Ref.: 1010168

Plástico desechable



Vasos blancos NPK



| CÓD. | DESCRIPCIÓN | Unds. | Paquetes |
|------|-----------------------------|-------|----------|
| 3360 | Vaso expresso 80 cc | 50 | 84 |
| 0455 | Vaso café 100 cc | 50 | 20 |
| 2906 | Vaso agua 200 cc | 100 | 30 |
| 1044 | Vaso agua 220 cc | 100 | 20 |
| 1796 | Vaso agua 220 cc base ancha | 100 | 20 |

No se astilla, es flexible y prácticamente irrompible. Producido con material de alta resistencia que soporta temperaturas entre -20° y 120° C.

Vasos transparentes NPK



| CÓD. | DESCRIPCIÓN | Unds. | Paquetes |
|------|-----------------------------|-------|----------|
| 0506 | Vaso agua 200 cc | 100 | 30 |
| 0642 | Vaso agua 220 cc | 100 | 30 |
| 0710 | Vaso agua 200 cc base ancha | 100 | 20 |
| 0685 | Vaso refresco 250 cc | 25 | 18 |
| 0760 | Vaso cerveza 330 cc | 100 | 30 |
| 0641 | Vaso cerveza 350 cc | 50 | 25 |
| 0588 | Vaso cerveza 500 cc | 50 | 16 |
| 1502 | Vaso litrona 1000 cc | 25 | 20 |

Vasos inyectados



| CÓD. | DESCRIPCIÓN | Unds. | Paquetes |
|------|----------------------|-------|----------|
| 2610 | Vaso chupito 40 cc | 50 | 45 |
| 2622 | Vaso fino 100 cc | 50 | 24 |
| 2641 | Vaso whisky 250 cc | 50 | 25 |
| 2660 | Vaso chiquito 210 cc | 20 | 12 |
| 2605 | Vaso pinta 330 cc | 30 | 17 |
| 2688 | Vaso sidra 600 cc | 20 | 12 |
| 2631 | Vaso tubo VIC 300 cc | 10 | 42 |

Vasos foam

| CÓD. | DESCRIPCIÓN | Unds. | Paq. |
|------|-----------------------------|-------|------|
| 4128 | Vaso foam 200 cc | 50 | 20 |
| 4124 | Vaso foam 300 cc (café) | 50 | 20 |
| 4125 | Vaso foam 350 cc (Sundance) | 50 | 20 |



Tienen gran capacidad de aislamiento térmico.

Copas inyectadas

| CÓD. | DESCRIPCIÓN | Unds. | Paq. |
|------|----------------------------|-------|------|
| 3260 | Copa cava 150 cc | 8 | 22 |
| 2523 | Copa cava 150 cc pie negro | 6 | 32 |
| 2516 | Copa cava 140 cc | 6 | 34 |
| 2721 | Copa cava 170 cc | 8 | 12 |

Cubiertos plástico

| CÓD. | DESCRIPCIÓN | Unds. | Paq. |
|------|----------------|-------|------|
| 2372 | Cuchara | 100 | 30 |
| 2374 | Tenedor | 100 | 30 |
| 2373 | Cuchillo | 100 | 30 |
| 2057 | Cuchara café | 100 | 30 |
| 2054 | Cuchara postre | 100 | 35 |



Platos plástico



| CÓD. | DESCRIPCIÓN | cm | Unds. | Paquetes |
|------|----------------------|------|-------|----------|
| 1609 | Plato plástico | 16,5 | 100 | 9 |
| 1669 | Plato plástico | 20,5 | 100 | 10 |
| 1964 | Plato plástico | 22 | 100 | 9 |
| 3935 | Plato plástico | 25 | 50 | 8 |
| 1969 | Plato plástico hondo | 22 | 50 | 9 |

Bolsas gofrada envasado al vacío



| Descripción | Med. mm. | Pack |
|---------------|-----------|--------|
| Bolsa gofrada | 150 x 250 | 100 U. |
| Bolsa gofrada | 170 x 250 | 100 U. |
| Bolsa gofrada | 200 x 300 | 100 U. |
| Bolsa gofrada | 200 x 250 | 100 U. |
| Bolsa gofrada | 250 x 350 | 100 U. |
| Bolsa gofrada | 300 x 400 | 100 U. |

Otras medidas a consultar

Bolsas lisas envasado al vacío de 90 y 150 micras

| Descripción | Med. mm. | Pack |
|-------------|-----------|--------|
| Bolsa lisa | 150 x 200 | 100 U. |
| Bolsa lisa | 170 x 250 | 100 U. |
| Bolsa lisa | 200 x 300 | 100 U. |
| Bolsa lisa | 200 x 250 | 100 U. |
| Bolsa lisa | 200 x 200 | 100 U. |
| Bolsa lisa | 250 x 350 | 100 U. |
| Bolsa lisa | 250 x 300 | 100 U. |
| Bolsa lisa | 250 x 400 | 100 U. |
| Bolsa lisa | 300 x 400 | 100 U. |
| Bolsa lisa | 350 x 500 | 100 U. |

Otras medidas a consultar



Bolsas cocción al vacío

| Descripción | Med. mm. | Pack |
|---------------------|-----------|--------|
| Bolsa cocción vacío | 180 x 250 | 100 U. |
| Bolsa cocción vacío | 200 x 300 | 100 U. |
| Bolsa cocción vacío | 300 x 400 | 100 U. |
| Bolsa cocción vacío | 300 x 500 | 100 U. |

Otras medidas a consultar

Aluminio y Film



| Código | Descripción | Medidas cm. |
|------------|-----------------------------|-------------|
| ALUM-HOT30 | Bobina aluminio profesional | 30 x 13 |
| ALUM-HOT40 | Bobina aluminio profesional | 40 x 13 |
| FILM-HOT30 | Bobina film profesional | 30 x 250 |
| FILM-HOT40 | Bobina film profesional | 45 x 250 |



Toallitas

Toallita Air bag



| Código | Descripción | Pack |
|----------|--|----------|
| HTAIRDON | Toallita air bag Hoteralia (20 cajas de 50 piezas) | 1.000 U. |

Personalización: precios a consultar en función de la cantidad y número de colores.



Tejido



| Código | Descripción | Pack |
|--------|-------------------------|--------|
| TLT100 | Toallita limón standard | 100 U. |
| TLT500 | Toallita limón standard | 500 U. |

Personalización: precios a consultar en función de la cantidad y número de colores.



| Código | Descripción | Pack |
|----------|---------------------------|---------|
| TLUXL200 | Toallita limón luxury | 200 U. |
| TLUXT200 | Toallita té verde luxury | 200 U.. |
| TLUXA200 | Toallita aloe vera luxury | 200 U. |

Amenities

Jabones



| Descripción | Embal. |
|---------------------------------|--------|
| Jabón 15 grs. redondo | 1.000 |
| Jabón 30 grs. redondo | 500 |
| Jabón 10 grs. rectangular | 1.000 |
| Jabón 11 grs. rectangular eco | 1.000 |
| Jabón 20 grs. glicerina ovalado | 500 |

Tubos-sachets



| Descripción | Embal. |
|------------------------------------|--------|
| Tubo gel o champú 30 ml. | 500 |
| Tubo gel o champú 20 ml. | 500 |
| Tubo gel o champú (2 en 1) 20 ml. | 500 |
| Tubo crema corporal 30 ml. | 500 |
| Tubo crema corporal 20 ml. | 500 |
| Sachet gel o champú 10 m. | 800 |
| Sachet gel o champú (2 en 1) 10 m. | 1.000 |

Otras colecciones



| Colección | Descripción | Embal. |
|-----------------------------|----------------------------|--------|
| ROMERO JAZMÍN GRAFITO | Lustr Zapatos | 1.000 |
| | Pañuelos 5 U. | 1.000 |
| | Gorro ducha | 1.000 |
| | Peine recto 2 puas | 1.000 |
| | Set dental + tubo crema | 500 |
| | Set afeitador + tubo crema | 500 |
| | Set costura | 1.000 |
| | Set femenino | 1.000 |

Concentrados

HT DEGRAS

NOVEDAD

Concentrado desengrasante baja alcalinidad



Producto indicado para utilizar en sistemas de disolución de concentrados. El producto resultante es indicado para la limpieza de superficies engrasadas. Puede utilizarse tanto con agua caliente como fría (limpieza de cocinas, superficies, utensilios, etc.) Apto para la industria alimentaria. Apto para uso en la industria alimentaria.

DOSIFICACION Y MODO DE EMPLEO Utilizar mediante sistemas de disolución de concentrado.

Disolución adecuada: entre 1:9 – 1:7

Disolución de uso: 10% - 14%.

COMPOSICION QUIMICA CUALITATIVA Tensioactivos aniónicos Tensioactivos no iónicos Solventes Álcalis Agentes Secuestrantes Perfume

PROPIEDADES FISICO-QUIMICAS

Aspecto: Líquido
 Color: Amarillo
 PH (5%): 11,5 - 12,5
 Densidad (20° C): 1,025 +/- 0,01 grs/c.c.

PRESENTACION Envases de 2 Lts.



HT MAN

NOVEDAD

Concentrado lavavajillas

Producto indicado para su utilización en sistemas de disolución de concentrados. El producto resultante es ideal para la limpieza manual de vajillas, cristalerías, cuberterías, etc. Posee un agradable perfume, reengrasantes de la piel y mantiene un elevado poder espumante.

DOSIFICACION Y MODO DE EMPLEO Utilizar en sistemas de disolución de concentrados.

Disolución adecuada: 1:3

Disolución de uso: directo.

COMPOSICION QUIMICA CUALITATIVA Tensioactivos aniónicos Tensioactivos anfotéricos Perfume Espesante

PROPIEDADES FISICO-QUIMICAS

Aspecto: Líquido viscoso
 Color: Verde
 Densidad (20°C): 1'04 +/- 0'01 g/cm3
 pH (100%): 5'5 – 6'5

PRESENTACION Envases de 2 Lts.

Lavado Vajilla



HTC 100 BLANDAS

Detergente lavado automático

Detergente líquido concentrado, alcalino y exento de espuma para el lavado automático de vajillas y utensilios en lavavajillas industriales (0-15°F).



HTC 101 MEDIAS

Detergente lavado automático semiduras

Detergente líquido concentrado, alcalino y exento de espuma formulado para el lavado automático de vajillas y utensilios en lavavajillas industriales, con aguas semiduras (0-26°F).



HTC 102 MUY DURAS

Detergente lavado automático aguas muy duras

Detergente líquido concentrado, alcalino y exento de espuma formulado para el lavado automático de vajillas y utensilios en lavavajillas industriales, con aguas muy duras (0-57°F).



HTC 104 CRISTAL

Detergente lavado automático especial cristalería

Producto especial para el lavado de cristalería en máquinas automáticas. Alta concentración en secuestrantes y dispersantes, evitando la formación de cercos en las piezas de cristal. Especialmente indicado para el lavado de utensilios de aluminio, así como aditivo para la limpieza en hornos. Exento de espuma, adecuado para aguas de elevada dureza.



HTC 150 BRILL MEDIAS

Abrillantador lavado automático aguas semiduras

Producto de gran concentración destinado a la fase de abrillantado de la vajilla y la cristalería en lavavajillas industriales con aguas semiduras de (0-40°F).



HTC 152 BRILL DURAS

Abrillantador lavado automático aguas muy duras

Producto de gran concentración destinado a la fase de abrillantado de la vajilla y la cristalería en lavavajillas industriales con aguas semiduras de (0-55°F).



HTC 175 DESIN

Desincrustante lavavajillas

Es un producto de marcado carácter ácido que actúa eficazmente como eliminador de incrustaciones de cal. Posee en su composición potentes inhibidores para evitar el ataque sobre los metales. No posee componentes fumantes ni produce gases molestos.



HTC 300 VAJILLAS

Lavavajillas manual concentrado

Detergente concentrado para el lavado manual de ollas, cacerolas, vajillas y todo tipo de utensilios de cocina.

| Código | 6 kgs.* | 12 kgs. | 24 kgs. |
|-------------------|---------|---------|---------|
| HTC 100 BLANDA | X | X | X |
| HTC 101 MEDIAS | X | X | X |
| HTC 102 MUY DURAS | X | X | X |
| HTC 104 CRISTAL | X | X | X |

* Los 6 kilos vienen en caja de 4 unidades.

| Código | 1 lt.* | 5 lts** | 10 lts. | 20 lts. |
|----------------------|--------|---------|---------|---------|
| HTC 150 BRIL MEDIAS | | X | X | X |
| HTC 152 BRIL DURAS | | X | X | X |
| HTC 175 DESIN | | X | | |
| HTC 300 LAVAVAJILLAS | X | X | X | |

* 1 litro viene en caja de 12 unidades.

** Los 5 litros vienen en caja de 4 unidades.

MAPA DE LA DUREZA DEL AGUA



Desengrasantes



HTC 201 GENERAL

Desengrasante general

Desengrasante general para la eliminación de grasas y suciedades en elementos de cocina, campanas extractoras, hornos, pavimentos, etc.



HTC 205 HIGIGRAS

Desengrasante higienizante

Enérgico limpiador desengrasante para todo tipo de residuos orgánicos, grasas, aceites y suciedades muy incrustadas, en trabajos de limpieza cocinas, utensilios, filtros, parrillas, contenedores de basuras, suelos de industrias, talleres, transporte, etc.



HTC 220 FORTE

Desengrasante concentrado

Desengrasante energético utilizable en la limpieza de grasas y suciedades muy incrustadas. Utilizable en frío o en caliente por ser un producto no inflamable.



HTC 200 PLANCHAS

Desengrasante energético planchas

Desengrasante energético, disuelve fácilmente cualquier tipo de suciedad, incluso grasas carbonizadas. Indicado para limpiar y desengrasar planchas, parrillas, filtros de campana, freidoras, etc. Aplicación en caliente.



HTC 230 PLANCHAS PLUS

Desengrasante planchas alto rendimiento

Desengrasante altamente alcalino para superficies muy sucias, grasas incrustadas o quemadas. Especialmente indicado para la limpieza de hornos, planchas, filtros, salamandras muy sucias, etc.



| Código | 750 cc.* | 5 lts.** |
|------------------|----------|----------|
| HTC 201GENERAL | X | X |
| HTC 205 HIGIGRAS | | X |
| HTC 220 FORTE | | X |

* Los 750 cc. vienen en caja de 12 unidades.

** Los 5 litros vienen en caja de 4 unidades.

| Código | 1,25kg* | 6 kg** |
|-----------------------|---------|--------|
| HTC 200 PLANCHAS | X | X |
| HTC 200 PLANCHAS PLUS | | X |

* 1,25 kgs. viene en caja de 12 unidades

** 6 kgs. viene en caja de 4 unidades

Higienizantes



HTC CLOR

Limpiador superficies clorado

Poderoso limpiador con gran capacidad tensoactiva y higienizante a la vez. Aplicable para limpieza y higienización de suelos de geriátricos, restaurantes, cafeterías y superficies donde se requiere una buena potencia de limpieza y higienización.



HTC VERCLOR

Desinfectante uso alimentario

Producto de alto poder desinfectante y amplio espectro bactericida y germicida. Elimina eficazmente gérmenes y bacterias en frutas y verduras. También se puede utilizar en la cloración de agua para consumo humano.

| Código | 5 lts. |
|--------|--------|
|--------|--------|

HTC CLOR X

HTC VERCLOR X

* Los 5 litros viene en caja de 4 unidades.



Suelos



HTS LIMON
Limpiador limón

Producto de amplias aplicaciones en la limpieza de suelos en mármol, terrazo, gres, mosaico, etc. Posee un agradable aroma a limón, dejando una sensación de frescura en los lugares donde se utiliza.



HTS FLORAL
Limpiador floral

Limpiador que posee en su composición una mezcla equilibrada de tensioactivos anionicos y no iónicos, ideal para aplicar en todo tipo de suelos (terrazo, cerámica, suelos sintéticos, etc.).



HTS MANZANA
Limpiador manzana

Producto de amplias aplicaciones en la limpieza de suelos, como mármol, terrazo, gres, mosaico, etc. Obtiene un agradable aroma a manzana verde, dejando una sensación de frescura.



HTS MARINO
Limpiador marino

Producto de amplias aplicaciones en la limpieza de suelos, como mármol, terrazo, gres, mosaico, etc. Alto poder desengrasante. Obtiene un agradable aroma a marino, dejando una sensación de frescura.



HTS AMONIC
Limpiador amoniacal

Producto de amplias aplicaciones en la limpieza de suelos, como mármol, terrazo, gres, mosaico, etc. Alto poder desengrasante. Su uso es muy recomendado en sitios y locales, donde se precise una limpieza a fondo.



HTS MARSELLA
Limpiador marsella

Producto de amplias aplicaciones en la limpieza de suelos, como mármol, terrazo, gres, mosaico, etc. Obtiene un agradable aroma a jabón de marsella, dejando una sensación de frescura.



HTS SOL
Limpiador espuma controlada

Limpiador neutro de baja espuma, para suelos resistentes al agua. Adecuado para usar con fregadora automática, así como con máquinas monodisco y sistemas de fregado manual. Neutraliza las moléculas responsables de los malos olores, intensificando el efecto del perfume y dejando una fresca fragancia.



HTS BAN
Limpiador repelente de insectos

Especialmente indicado para la limpieza diaria de suelos de todo tipo de instituciones, sin atacar el brillo en cualquier tipo de material, mármol, terrazo, gres, madera, etc. Deja una película con acción repelente para ahuyentar a todo tipo de insectos rastreros.



HTS WOOD
Limpiador jabonoso madera

Producto ideal para la limpieza de todo tipo de superficies de madera y parquet. Posee en su formulación jabones y agentes nutrientes para la madera, consiguiendo limpiar y nutrir al mismo tiempo. Respeta el aspecto original de la madera, no deja residuos y no precisa aclarado, dejando un agradable perfume.

| Código | 1 lt.* | 5 lts** | 10 lts. |
|--------------|--------|---------|---------|
| HTS LIMÓN | | X | X |
| HTS FLORAL | X | X | |
| HTS MANZANA | | X | X |
| HTS MARINO | X | X | X |
| HTS AMONIC | X | X | |
| HTS MARSELLA | | X | |
| HTS SOL | | X | |
| HTS BAN | | X | |
| HTS WOOD | | X | |

* 1 litro viene en caja de 12 unidades.

** Los 5 litros vienen en caja de 4 unidades.



Superficies



HT GLASS

Limpiacristales multiusos

Producto para la limpieza diaria que proporciona un brillo extraordinario sin velos ni marcas. Elimina la suciedad más resistente. Indicado para todo tipo de superficies, ventanas, espejos, cristales, acero inoxidable, puertas, objetos decorativos, televisores, etc.



HT MULTISS

Limpiador multiusos

Disuelve y elimina de manera rápida y eficaz suciedades en cuartos de baño, habitaciones, comedores, salas, zonas comunes y en general todo tipo de superficies que permitan ser mojadas como: cerámica, gres, mármol, grifería, azulejos, cromados, esmaltados, superficies plásticas, etc.



HTS INOX

Abrillantador de acero inoxidable

Crea un efecto antiestático y de protección frente a grasas y suciedades. Por su fácil aplicación y alto rendimiento, es idóneo en superficies de acero inoxidable (mostradores, mobiliario de colectividades, frigoríficos, etc.), así como superficies de aluminio y cromadas.

| Código | 750cc* | 5 lts.** |
|-------------|--------|----------|
| HT GLASS | X | X |
| HTC MULTISS | X | X |
| HTC INOX | X | |

* 750 cc viene en caja de 12 unidades.

** Los 5 litros vienen en caja de 4 unidades.



Baños



HTB 550 CALC

Detergente anticalcáreo

Esta indicado para el mantenimiento diario de baños, griferías, suelos y revestimientos en general. Con su utilización podremos evitar la acumulación de cal y la formación de incrustaciones. No altera superficies cromadas, dándoles un aspecto brillante. Su efecto limpiador junto a su agradable perfume ofrecen un elevado rendimiento higienizante.



HTB LIMP

Limpiador concentrado baños

Limpiador multiusos higienizante perfumado para la limpieza de todo tipo de superficies duras resistentes al agua, baños, suelos, paredes, oficinas, lavabos, etc. Su formulación alcalina proporciona unas intensas propiedades desengrasantes. Deja las superficies perfectamente limpias y desodorizadas con una fresca fragancia a pino que dura horas.



HTB 560 W.C.

Limpiador w.c.

Producto creado para la desincrustación y limpieza, así como reducción de olores en aseos e inodoros químicos. Producto eficaz para la eliminación del sarro y restos calcáreos. Ideal para la limpieza de, azulejos, sanitarios, baños, etc. Posee poder higienizante en su composición. No aplicar directamente sobre griferías y superficies cromadas.

| Código | 750cc.* | 1 lts.** | 5 lts.*** |
|--------------|---------|----------|-----------|
| HTB 550 CALC | X | | X |
| HTB LIMP | | | X |
| HTB 560 W.C. | | X* | |

* 750 cc. vienen en caja de 12 unidades.

** 1 litro viene en caja de 6 unidades.

*** Los 5 litros vienen en caja de 4 unidades.

* 1 litro viene en caja de 12 unidades.



Higiene y limpieza

Bolsas de basura

| CÓD. | DESCRIPCIÓN | cm | Embalaje U. x rollos |
|--------|----------------------------------|-----------|----------------------|
| 45107 | Bolsa comunidad G/200 | 115 x 135 | 10 x 10 |
| 45213 | Bolsa industrial G/160 | 90 x 100 | 10 x 24 |
| 45415N | Bolsa industrial G/150 negro | 85 x 105 | 10 x 25 |
| 45415 | Bolsa industrial G/150 colores | 85 x 105 | 10 x 25 |
| 144106 | Bolsa doméstica G/90 | 52 x 58 | 25 x 50 |
| 144105 | Bolsa doméstica G/60 eco | 52 x 58 | 25 x 70 |
| 144111 | Bolsa doméstica G/80 cierrafácil | 55 x 60 | 20 x 40 |



Fregona microfibras



| CÓD. | DESCRIPCIÓN | Tamaño (gr) |
|--------|------------------------------|-------------|
| 100701 | Fregona microfibras blanca | 150 |
| 100750 | Fregona microfibras azul | 150 |
| 100760 | Fregona microfibras roja | 150 |
| 100770 | Fregona microfibras amarilla | 150 |
| 100780 | Fregona microfibras verde | 150 |



Fregona algodón

| CÓD. | DESCRIPCIÓN | Tamaño (gr) |
|--------|-----------------------|-------------|
| 100314 | Fregona algodón extra | 185 |
| 100318 | Fregona algodón extra | 205 |
| 100353 | Fregona algodón extra | 250 |
| 100313 | Fregona algodón extra | 275 |
| 100311 | Fregona algodón extra | 295 |



Mopas fregado



| CÓD. | DESCRIPCIÓN | Tamaño (gr) |
|--------|-------------------------------|-------------|
| 201100 | Mopa algodón extra | 300 |
| 201101 | Mopa algodón extra | 350 |
| 201103 | Mopa algodón extra | 400 |
| 201105 | Mopa algodón extra | 450 |
| 201201 | Mopa sintética tiras cuadros | |
| 201202 | Mopa sintética tiras amarilla | |
| 480400 | Pinza sujeción mopa | |

Carros/cubo

| CÓD. | DESCRIPCIÓN | Tamaño (lts.) |
|--------|---|---------------|
| 409055 | Carro 1 seno con prensa. Tamaño: 40 x 50 x 96 cm. | 25 |
| 409056 | Carro 2 senos con prensa. Tamaño: 41 x 74 x 105 cm. | 25 + 25 |
| 460513 | Cubo con escurridor (azul, rojo, amarillo y verde) | 14 |



Cepillos/recogedor

| CÓD. | DESCRIPCIÓN | Tamaño (cm) |
|--------|--------------------------|-------------|
| 460106 | Cepillo fuerte | 34 |
| 460107 | Cepilo suave | 34 |
| 460507 | Recogedor | 110 |
| 530214 | Mango aluminio | 140 |
| 530715 | Mango aluminio anodizado | 150 |



Higiene y limpieza

Gama de abrasivos, bayetas y paños



| CÓD. | DESCRIPCIÓN | FORMATO |
|-----------|--------------------------------------|-----------|
| HTCL00405 | Rollo estropajo fibra verde | 6 m |
| HTCL00359 | Salvauñas gigante profesional | 7 x 14 cm |
| HTCL00314 | Estropajo acero inox. (Pack 10) | 40 grs. |
| HTCL00388 | Almohadillas abrasiva inox. (Pack 6) | Pack 6 |

| CÓD. | DESCRIPCIÓN | cm |
|------|--------------------------|------------|
| 330 | Piedra pomez extra pomez | 10 x 7 x 4 |

| CÓD. | DESCRIPCIÓN | FORMATO |
|-----------|---|---------|
| HTCL00875 | Bayeta microfibras, varios colores | Pack 6 |
| HTCL00512 | Bayeta "multisoft" multiuso, varios colores | Pack 10 |
| HTCL00505 | Rollo amarillo "burbujas" precorta. | 8 m |
| HTCL00536 | Rollo bayeta "cruces universal" | 8 m. |
| HTCL01497 | Paño cocina superior 100% algodón | |

Bayetas microfibras



| CÓD. | DESCRIPCIÓN | cm |
|----------|-----------------------------|---------|
| 310407 | Bayeta Microfibras blanco | 38 x 40 |
| 31040701 | Bayeta Microfibras amarillo | 38 x 40 |
| 31040702 | Bayeta Microfibras azul | 38 x 40 |
| 31040703 | Bayeta Microfibras rojo | 38 x 40 |
| 31040704 | Bayeta Microfibras verde | 38 x 40 |

Bayetas microfibras extra



| CÓD. | DESCRIPCIÓN | cm |
|----------|-----------------------------------|---------|
| 310401 | Bayeta Microfibras extra blanco | 32 x 32 |
| 31040101 | Bayeta Microfibras extra azul | 32 x 32 |
| 31040102 | Bayeta Microfibras extra amarillo | 32 x 32 |
| 31040103 | Bayeta Microfibras extra rojo | 32 x 32 |
| 31040104 | Bayeta Microfibras extra verde | 32 x 32 |

Bayeta rollo



| CÓD. | DESCRIPCIÓN | cm/m |
|--------|------------------------------------|--------|
| 310159 | Rollo bayeta Universal | 40 x 8 |
| 310151 | Rollo bayeta multiuso | 40 x 8 |
| 310158 | Rollo bayeta sintética precortado* | 40 x 8 |
| 310206 | Rollo bayeta cristales | 40 x 8 |

* Consultar colores

Paños



| CÓD. | DESCRIPCIÓN | cm |
|--------|--------------------|---------|
| 310309 | Paño cocina azul | 55 x 55 |
| 310302 | Paño cocina blanco | 55 x 55 |
| 310111 | Rejilla blanca | 40 x 45 |

- 1 **Aldea Suministros de Hostelería S.L.** C/ Murcia, 11 Dcha, Pol. Ind. Vicolozano, 05194 - Vicolozano (Ávila)
Tel. 920 259 021 - info@aldeasuministros.com - www.aldeasuministros.com
- 2 **Bohajar S.L.** Avda. de Murcia, 105, 30836 - Puebla de Soto (Murcia)
Tel. 968 898 315 - suministros@bohajar.com - www.bohajar.com
- 3 **Comercial Sirviella S.L.** Glorieta Puente de Segovia, 3, 28011 - Madrid
Tel. 914 797 465 - sirviella@sirviella.com - www.sirviella.com
- 4 **Crisberlin S.L.** C/ Algimia de Alfara, 1 y 3, 46013 - Valencia
Tel. 963 344 962 - crisberlin@crisberlin.com - www.crisberlin.com
- 5 **Elzu Industrial S.A.** C/ Martin Etxeberria, 9-11, 20100 - Rentería (Guipúzcoa)
Tel. 943 511 237 - info@elzu.com - www.elzu.com
- 6 **Equip-Vic Girona** Avda. Gran Via Jaume I, 13, 17001 - Girona
Tel. 972 221 423 / 972 478 932 - girona@equipvic.com - www.equipvic.com
- 7 **Equip-Vic S.L.** C/ Serrallers, 8, Pol. Ind. El Verinal, 08551 - Tona (Barcelona)
Tel. 938 125 500 - info@equipvic.com - www.equipvic.com - Instagram: Espai Xef
- 8 **Ferrando Servicios Integrales S.L.** Ctra. Alcañiz, 64, 44003 - Teruel
Tel. 978 602 081 - administracion@comercialferrando.com - www.ferrandoserviciosintegrales.com
- 9 **Glassanz S.L.** C/ Constanca, 11, 28002 - Madrid
Tel. 914 135 190 - tienda@glassanz.com - info@glassanz.com - www.glassanz.com
- 10 **Hermanos López Pardo S.L.** C/ Zurbarán, 3, Pol. Ind. La Pañoleta, 29700 - Vélez-Málaga (Málaga)
Tel. 952 503 588 - ventas@lopezpardo.com - www.lopezpardo.com
- 11 **Hostelería Hogar S.L.** Travesía 16 de Agosto, 1, 48006 - Bilbao
Tel. 944 161 470 - info@hosteleriahogar.com - www.hosteleriahogar.com
- 12 **Hostelmec S.L. Fuerteventura** C/ El Diviso, 13, Pol. Ind. El Matorral, 35014 - Caleta de Fuste (Fuerteventura)
Tel. 928 163 411 - hostelmec@guerrayfernandez.es
- 13 **Hostelmec S.L. Lanzarote** C/ San Sebastián, 27, Barriada de Tenorio, 35500 - Arrecife (Lanzarote)
Tel. 928 815 127 - hostelmec@guerrayfernandez.es
- 14 **Hotelco Andorra** C/ Les Boïgues, 1, AD700 - Escaldes-Engordany (Andorra)
Tel. (+376) 720 711 - exposició@hotelco.ad - www.hotelco.ad
- 15 **Hotelco Seu d'Urgell** Carrer Major, 74, Baixos, 25700 - La Seu d'Urgell (Lleida)
Tel. (+902) 043 269 - botiga.seu@hotelco.ad
- 16 **Hoteralia Prestín** Pol. Empresarial del Prestín, 28, 33559 - Parres (Asturias)
Tel. 984 053 488 - elprestín@hoteraliacash.com
- 17 **Menaje Galicia S.L.** Rúa Otero Pedraio, 22, Bajo, 15679 - Cambre (A Coruña)
Tel. 981 667 076 - menajegalicia@menajegalicia.com - www.menajegalicia.com
- 18 **Myr Hostelería S.L.** C/ Soldado Español, 12 (Local), 40001 - Segovia
Tel. 921 442 495 - myrhosteleria@myrhosteleria.net - www.myrhosteleria.com
- 19 **Núñez Gil M.H.I. S.L.** Pilas de Panchía, 2, 14550 - Montilla (Córdoba)
Tel. 957 655 388 - comercial@nunezgil.com - www.nunezgil.com
- 20 **Promohostelería** Av. Vidal i Barraque, 32, 43002 - Tarragona
Tel. 977 91 47 48 - info@promohosteleria.es
- 21 **Suhosmar S.L.** Avda. Comuneros, 12-14, 45880 - Corral de Almaguer (Toledo)
Tel. 925 207 456 - 687 455 760 - info@suhosmar.com - www.suhosmar.com
- 22 **Suministros Hostelería Álvarez Gómez S.L.** Pol. Ind. Ombatillo, c/C s/n, 31591 - Corella (Navarra)
Tel. 948 780 859 - hosteleria@alvarez-gomez.com - www.alvarez-gomez.com
- 23 **Suministros Hostelería Llobregat S.L.** C/ Drets Humans, 13, P. Industrial Mas Alba, Naves 7 y 8, 08870 - Sitges (Barcelona) - Tel. 934 791 116
C/ Cami del Pla, 40-42, P. Industrial Mas Alba, 08870 - Sitges (Barcelona) - Tel. 931 188 967 - vimer@vimer.es - www.vimer.es
- 24 **Suministros Hostelería Vigón S.L.** C/ Eratóstenes, 52, Pol. Ind. Porceyo, 33211 - Gijón (Asturias) - Tel. (34) 985 168 459 - (34) 985 167 951
hosteleriavigon@hosteleriavigon.com - www.hosteleriavigon.com - gestion@hosteleriavigon.com - comercial@hosteleriavigon.com
- 25 **Suministros Matrio S.L.** C/ 31, 120, Pol. Ind. Catarroja, 46470 - Catarroja (Valencia)
Tel. 961 103 414 - matriox@matrio.net - www.matrio.net
- 26 **Suministros Tres Árboles S.L.** C/ Cobalto, 8, Nave 12, Pol. Ind. San Cristóbal, 47012 - Valladolid
Tel. 983 042 041 - valladolid@suministrostresarboles.com - www.suministrostresarboles.com
- 27 **Suministros Tres Árboles S.L.** C/ Muela Quebrada, 55-56 Pol. Ind. La Hiniesta, 49024 - Zamora
Tel. 980 160 076 - clientes@suministrostresarboles.com - www.suministrostresarboles.com
- 28 **Tomidoce S.L.** Polígono Industrial La Cerrajera, C/ Bodegueros, 9, 16003 - Cuenca
Tel. 969 232 704

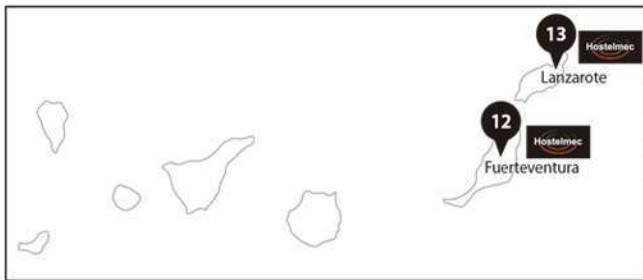
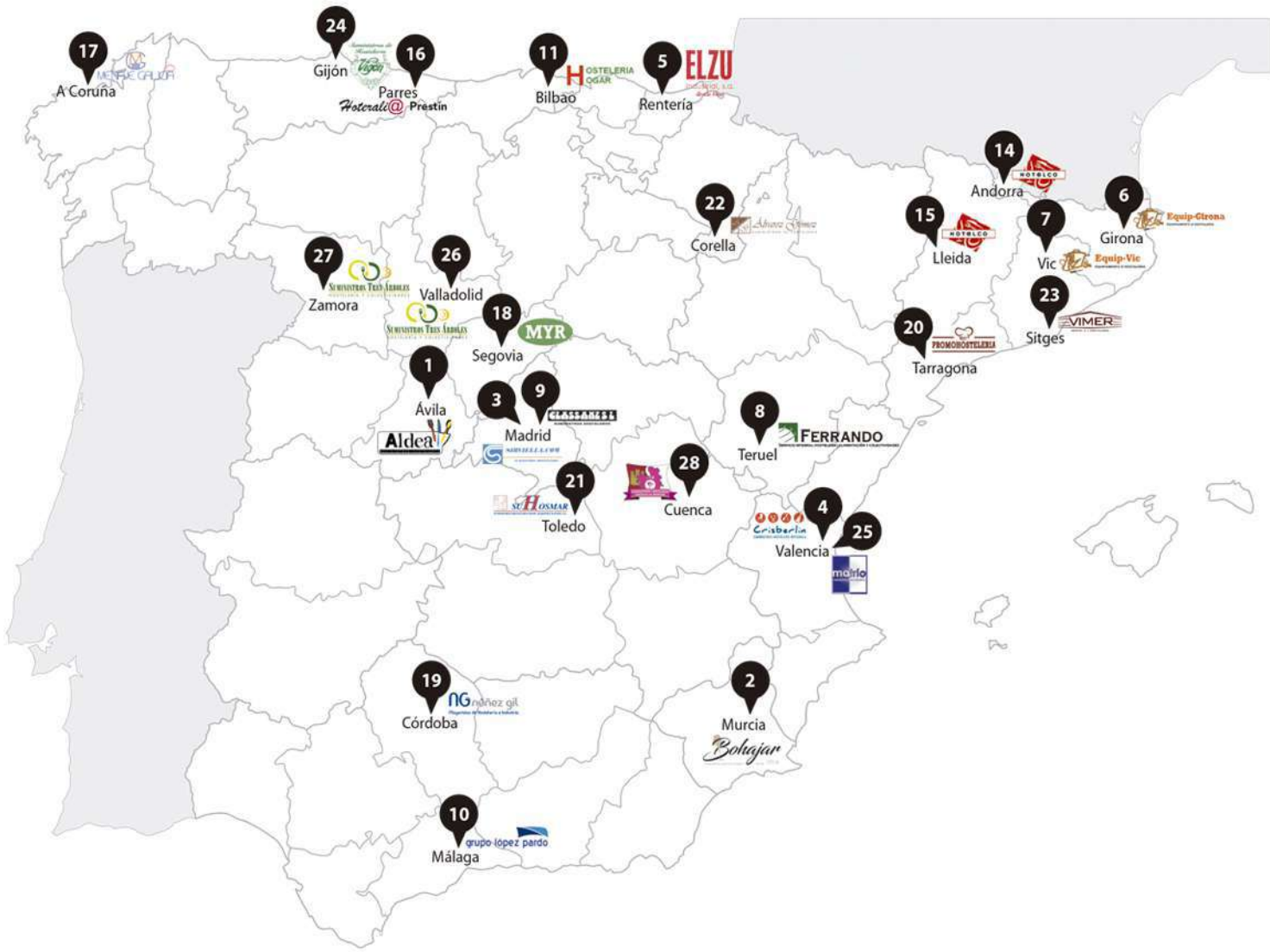

Hoterali@ GROUP

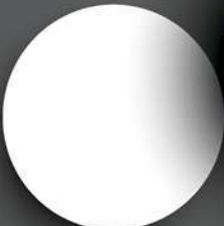
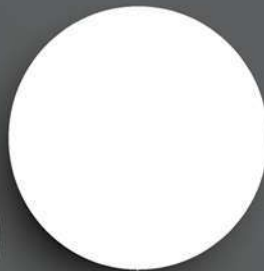
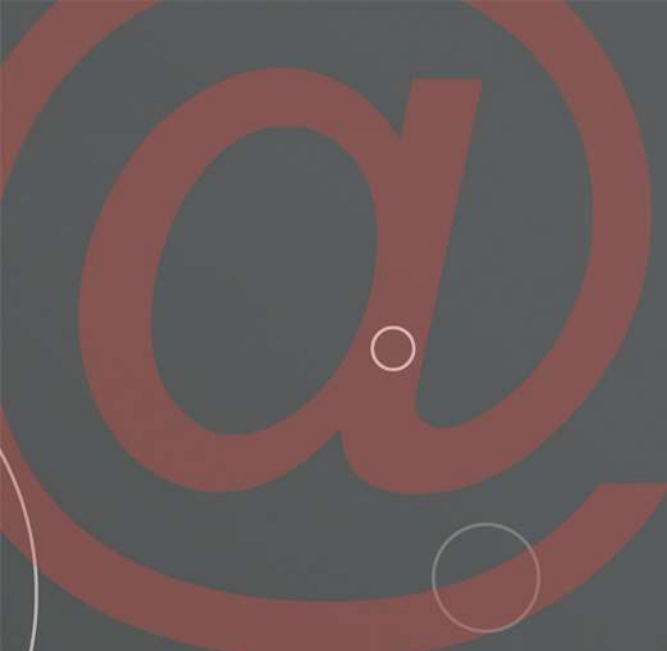

Asesoramiento personalizado para poner en marcha tu negocio. Explícanos tu idea y nosotros te ayudamos a desarrollarla.

Hoterali@, la fuerza de un gran grupo y la flexibilidad de las empresas que lo componen, nos otorgan el prestigio de ser referencia nacional en el sector.



Servicio inmediato en cualquier punto de España.



36,895 m² distribuidos en 44 almacenes en todo el ámbito nacional nos convierte en una red única en el servicio de mercancías para la hostelería y la restauración.

